

ISBN 92-64-01064-5
NEA/NSC/DOC(2004)21

NEA NUCLEAR SCIENCE COMMITTEE
NEA COMMITTEE ON SAFETY OF NUCLEAR INSTALLATIONS

BOILING WATER REACTOR TURBINE TRIP (TT) BENCHMARK

Volume II: Summary Results of Exercise 1

June 2005

by

Bedirhan Akdeniz and Kostadin N. Ivanov
Nuclear Engineering Program
The Pennsylvania State University
University Park, PA, 16802 USA

Andy M. Olson
Exelon Nuclear
200 Exelon Way, KSA2-N
Kennett Square, PA, 19348 USA

© OECD 2005
NEA No. 4448

**NUCLEAR ENERGY AGENCY
ORGANISATION FOR ECONOMIC CO-OPERATION AND DEVELOPMENT
AND US NUCLEAR REGULATORY COMMISSION**

ORGANISATION FOR ECONOMIC CO-OPERATION AND DEVELOPMENT

The OECD is a unique forum where the governments of 30 democracies work together to address the economic, social and environmental challenges of globalisation. The OECD is also at the forefront of efforts to understand and to help governments respond to new developments and concerns, such as corporate governance, the information economy and the challenges of an ageing population. The Organisation provides a setting where governments can compare policy experiences, seek answers to common problems, identify good practice and work to co-ordinate domestic and international policies.

The OECD member countries are: Australia, Austria, Belgium, Canada, the Czech Republic, Denmark, Finland, France, Germany, Greece, Hungary, Iceland, Ireland, Italy, Japan, Korea, Luxembourg, Mexico, the Netherlands, New Zealand, Norway, Poland, Portugal, the Slovak Republic, Spain, Sweden, Switzerland, Turkey, the United Kingdom and the United States. The Commission of the European Communities takes part in the work of the OECD.

OECD Publishing disseminates widely the results of the Organisation's statistics gathering and research on economic, social and environmental issues, as well as the conventions, guidelines and standards agreed by its members.

* * *

This work is published on the responsibility of the Secretary-General of the OECD. The opinions expressed and arguments employed herein do not necessarily reflect the official views of the Organisation or of the governments of its member countries.

NUCLEAR ENERGY AGENCY

The OECD Nuclear Energy Agency (NEA) was established on 1st February 1958 under the name of the OEEC European Nuclear Energy Agency. It received its present designation on 20th April 1972, when Japan became its first non-European full member. NEA membership today consists of 28 OECD member countries: Australia, Austria, Belgium, Canada, the Czech Republic, Denmark, Finland, France, Germany, Greece, Hungary, Iceland, Ireland, Italy, Japan, Luxembourg, Mexico, the Netherlands, Norway, Portugal, Republic of Korea, the Slovak Republic, Spain, Sweden, Switzerland, Turkey, the United Kingdom and the United States. The Commission of the European Communities also takes part in the work of the Agency.

The mission of the NEA is:

- to assist its member countries in maintaining and further developing, through international co-operation, the scientific, technological and legal bases required for a safe, environmentally friendly and economical use of nuclear energy for peaceful purposes, as well as
- to provide authoritative assessments and to forge common understandings on key issues, as input to government decisions on nuclear energy policy and to broader OECD policy analyses in areas such as energy and sustainable development.

Specific areas of competence of the NEA include safety and regulation of nuclear activities, radioactive waste management, radiological protection, nuclear science, economic and technical analyses of the nuclear fuel cycle, nuclear law and liability, and public information. The NEA Data Bank provides nuclear data and computer program services for participating countries.

In these and related tasks, the NEA works in close collaboration with the International Atomic Energy Agency in Vienna, with which it has a Co-operation Agreement, as well as with other international organisations in the nuclear field.

© OECD 2005

No reproduction, copy, transmission or translation of this publication may be made without written permission. Applications should be sent to OECD Publishing: rights@oecd.org or by fax (+33-1) 45 24 13 91. Permission to photocopy a portion of this work should be addressed to the Centre Français d'exploitation du droit de Copie, 20 rue des Grands Augustins, 75006 Paris, France (contact@cfcopies.com).

FOREWORD

The OECD Nuclear Energy Agency (NEA) completed under US Nuclear Regulatory Commission (NRC) sponsorship a PWR main steam line break (MSLB) benchmark against coupled system three-dimensional (3-D) neutron kinetics and thermal-hydraulic codes. Another OECD/NRC coupled-code benchmark was recently completed for a BWR turbine trip (TT) transient and is the object of the present report.

Turbine trip transients in a BWR are pressurisation events in which the coupling between core space-dependent neutronic phenomena and system dynamics plays an important role. The data made available from actual experiments carried out at the Peach Bottom 2 plant make the present benchmark particularly valuable. While defining and co-ordinating the BWR TT benchmark, a systematic approach and level methodology not only allowed for a consistent and comprehensive validation process, but also contributed to the study of key parameters of pressurisation transients. The benchmark consists of three separate exercises, two initial states and five transient scenarios.

The BWR TT Benchmark will be published in four volumes as NEA reports. CD-ROMs will also be prepared and will include the four reports and the transient boundary conditions, decay heat values as a function of time, cross-section libraries and supplementary tables and graphs not published in the paper version. *BWR TT Benchmark – Volume I: Final Specifications* was issued in 2001 [NEA/NSC/DOC(2001)1]. The benchmark team [Pennsylvania State University (PSU) in co-operation with Exelon Nuclear and the NEA] has been responsible for co-ordinating benchmark activities, answering participant questions and assisting them in developing their models, as well as analysing submitted solutions and providing reports summarising the results for each phase. The benchmark team has also been involved in the technical aspects of the benchmark, including sensitivity studies for the different exercises. In performing these tasks, the PSU team has been collaborating with Andy M. Olson and Kenneth W. Hunt of Exelon Nuclear. Lance J. Agee, of the Electric Power Research Institute (EPRI), has also provided technical assistance for this international benchmark project.

Volume II summarises the results for Exercise 1 of the benchmark and identifies the key parameters and important issues concerning the thermal-hydraulic system modelling of the TT transient with specified core average axial power distribution and fission power (or reactivity) time transient history. Exercise 1 helped the participants initialise and test their system code models for further use in Exercise 3 on coupled 3-D kinetics/system thermal-hydraulics simulations.

Readers are invited to note that many of the original graphics in the report are in colour; colour versions are available online at the NEA website (www.nea.fr).

Acknowledgements

The authors would like to thank Professor J. Aragonés of UPM, Dr. T. Lefvert and Dr. S. Langenbuch of GRS, and Dr. F. Eltawila of NRC, whose support and encouragement in establishing this benchmark were invaluable.

This report is the sum of many efforts – the participants and the funding agencies and their staff, including the US Nuclear Regulatory Commission and the Organisation of Economic Co-operation and Development. Special appreciation is due to: L. Agee of EPRI, Professor T. Downar of Purdue University, B. Aktas of ISL Inc., Dr. G. Gose and Dr. C. Peterson from CSA, Dr. A. Hotta of TSI, Dr. P. Coddington of PSI and Dr. U. Grundmann of FZR. Their technical assistance, comments and suggestions were very valuable. We would like to thank them for the effort and time involved.

Of particular note are the labours of Dr. F. Eltawila, assisted by Dr. J. Han and Dr. J. Uhle of the US Nuclear Regulatory Commission. Through their endeavours, funding was secured for this project. We also thank them for their invaluable technical advice and assistance.

The authors wish to express their sincere appreciation for the outstanding support offered by Dr. E. Sartori, who provides efficient administration, organisation and valuable technical advice.

The authors would also like to particularly thank all of the OECD/NEA BWR Turbine Trip Benchmark participants for their valuable support, comment and feedback during this study.

Special thanks are due to the authors' family members for their encouragement, support and patience throughout the course of this work.

Finally, the authors are grateful to A. Griffin-Chahid for having devoted her competence and skills to the editing of this report.

TABLE OF CONTENTS

Foreword	3
List of Figures	7
List of Tables	9
List of Abbreviations	11
Chapter 1 INTRODUCTION	13
Chapter 2 DESCRIPTION OF EXERCISE 1	15
2.1 General	15
2.2 Description of turbine trip scenario.....	15
2.3 Initial steady state conditions	16
2.4 Transient calculations.....	18
Chapter 3 METHODOLOGIES FOR COMPARATIVE ANALYSIS	19
3.1 Standard techniques for the comparison of results.....	19
3.1.1 Integral parameter values	19
3.1.2 One-dimensional (1-D) axial distributions	20
3.1.3 Time histories.....	20
3.2 ACAP analysis	21
Chapter 4 RESULTS AND DISCUSSION OF EXERCISE 1	27
Chapter 5 CONCLUSIONS	65
References	67
Appendix A Description of computer codes used for analysis of Exercise 1 of the NEA-NRC BWR TT Benchmark.....	69
CATHARE (CEA, France).....	71
S-RELAP5 (FANP, Germany).....	73
ATHLET (GRS, Germany)	73
DNB/3D (NETCORP, USA).....	73
TRAC-BF1 (NFI, Japan).....	74

TRAC-BF1 (NUPEC, Japan)	74
RETRAN-3D (PSI, Switzerland)	74
TRAC-BF1/MOD1 (PSU, USA).....	75
TRAC-M (PSU/NRC, USA)	77
TRAC-BF1-ENTRÉE (TEPSYS, Japan)	78
RELAP5 (UPISA, Italy).....	80
TRAC-BF1-VALKIN (UPV, Spain).....	80
POLCA-T (Westinghouse, Sweden)	81
Appendix B Questionnaire for Exercise 1 of the NEA-NRC BWR TT Benchmark	85
CATHARE2 v1.5 (CEA, France).....	88
S-RELAP5 (FANP, Germany).....	91
ATHLET (GRS, Germany)	94
DNB/3D (NETCORP, USA).....	97
TRAC-BF1 (NFI, Japan).....	103
TRAC-BF1 (NUPEC, Japan)	106
RETRAN-3D (PSI, Switzerland)	109
TRAC-BF1 (PSU, USA)	116
TRAC-M (PSU/NRC, USA)	118
TRAC-BF1 (TEPSYS, Japan).....	121
RELAP5 (UPISA, Italy).....	123
TRAC-BF1-VALKIN (UPV, Spain).....	127
POLCA-T (Westinghouse, Sweden)	130

List of Figures

Figure 2.3-1.	PB2 TT2 initial core axial average power distribution from P1 edit.....	17
Figure 3.2-1.	FOM configuration in ACAP	22
Figure 4-1.	Core inlet enthalpy.....	30
Figure 4-2.	Core pressure drop.....	31
Figure 4-3.	Core average void fraction distribution	32
Figure 4-4.	Core average void fraction distribution	32
Figure 4-5.	Void fraction distribution – averaged vs. Exelon data.....	33
Figure 4-6.	Void fraction distribution – Exelon and deviation.....	33
Figure 4-7.	Vessel dome pressure (5 seconds)	36
Figure 4-8.	Vessel dome pressure (5 seconds)	36
Figure 4-9.	Vessel dome pressure – measured vs. averaged data (5 seconds)	37
Figure 4-10.	Vessel dome pressure (1.5 seconds)	38
Figure 4-11.	Vessel dome pressure (1.5 seconds)	38
Figure 4-12.	Vessel dome pressure – measured vs. averaged data (1.5 seconds)	39
Figure 4-13.	Core exit pressure (5 seconds).....	40
Figure 4-14.	Core exit pressure (5 seconds).....	40
Figure 4-15.	Core exit pressure – Exelon vs. averaged data (5 seconds)	41
Figure 4-16.	Core exit pressure (1.5 seconds).....	42
Figure 4-17.	Core exit pressure (1.5 seconds).....	42
Figure 4-18.	Core exit pressure – Exelon vs. averaged data (1.5 seconds)	43
Figure 4-19.	Jet pump flow rate (5 seconds)	44
Figure 4-20.	Jet pump flow rate (5 seconds)	44
Figure 4-21.	Jet pump flow rate – Exelon vs. averaged data (5 seconds)	45
Figure 4-22.	Jet pump flow rate (1.5 seconds)	46
Figure 4-23.	Jet pump flow rate (1.5 seconds)	46

Figure 4-24.	Jet pump flow rate – Exelon vs. averaged data (5 seconds)	47
Figure 4-25.	Core in-channel flow rate (5 seconds)	48
Figure 4-26.	Core in-channel flow rate (5 seconds)	48
Figure 4-27.	Core in-channel flow rate – Exelon vs. averaged data (5 seconds)	49
Figure 4-28.	Core in-channel flow rate (1.5 seconds)	50
Figure 4-29.	Core in-channel flow rate (1.5 seconds)	50
Figure 4-30.	Core in-channel flow rate – Exelon vs. averaged data (1.5 seconds)	51
Figure 4-31.	Steam bypass flow rate (5 seconds.)	52
Figure 4-32.	Steam bypass flow rate (5 seconds)	52
Figure 4-33.	Steam bypass flow rate – Exelon vs. averaged data (5 seconds)	53
Figure 4-34.	Steam bypass flow rate (1.5 seconds)	54
Figure 4-35.	Steam bypass flow rate (1.5 seconds)	54
Figure 4-36.	Steam bypass flow rate – Exelon vs. averaged data (1.5 seconds)	55
Figure 4-37.	Turbine inlet pressure (5 seconds)	56
Figure 4-38.	Turbine inlet pressure (5 seconds)	56
Figure 4-39.	Turbine inlet pressure (1.5 seconds)	58
Figure 4-40.	Turbine inlet pressure (1.5 seconds)	58
Figure 4-41.	RETRAN PB2 thermal-hydraulic model	61
Figure A-1.	TEPSYS modifications in control block INTM	79
Figure B-1.	CEA nodalisation diagram	88
Figure B-2.	FANP nodalisation diagram	91
Figure B-3.	GRS reactor pressure vessel nodalisation schema	94
Figure B-4.	GRS steam line nodalisation schema	95
Figure B-5.	NETCORP reactor vessel nodalisation	99
Figure B-6.	NETCORP schematic of BWR NSSS representation	99
Figure B-7.	NETCORP’s method of characteristics of main system	100

Figure B-8.	NETCORP schematic of reactor vessel geometry for jet pumps.....	101
Figure B-9.	NETCORP flow diagram within reactor vessel for jet pumps	102
Figure B-10.	NETCORP DNB/3D equations	102
Figure B-11.	NFI TRAC-BF1 nodalisation diagram	103
Figure B-12.	NFI TRAC-BF1 steam line nodalisation	104
Figure B-13.	NUPEC Peach Bottom 2 plant nodalisation	106
Figure B-14.	PSI nodalisation of the reactor vessel.....	110
Figure B-15.	PSI nodalisation of the channels.....	111
Figure B-16.	PSI nodalisation of the steam line.....	112
Figure B-17.	Nodalisation of the steam separator region.....	114
Figure B-18.	PSU TRAC-BF1 nodalisation.....	116
Figure B-19.	PSU/NRC TRAC-M nodalisation.....	119
Figure B-20.	PSU/NRC TRAC-M jet pump nodalisation.....	120
Figure B-21.	PSU/NRC TRAC-M separator nodalisation	120
Figure B-22.	TEPSYS TRAC-BF1 plant model	121
Figure B-23.	UPISA RELAP5 model	124
Figure B-24.	UPISA steam line simplified schema	124
Figure B-25.	UPV thermal-hydraulic nodalisation	127
Figure B-26.	UPV thermal-hydraulic channel map	128
Figure B-27.	UPV steam line nodalisation.....	128

List of Tables

Table 1-1.	List of participants in Exercise 1 of the BWR TT benchmark.....	14
Table 2.3-1.	PB2 TT2 initial conditions from process computer P1 edit.....	16
Table 2.3-2.	PB2 TT2 initial core average axial power distribution from P1 edit	17
Table 2.4-1.	PB TT2 event timing (time in milliseconds).....	18
Table 4-1.	Participant models used in Exercise 1 of the BWR TT benchmark.....	29

Table 4-2.	Core inlet enthalpy – deviation (e_i) and FOM	30
Table 4-3.	Core pressure drop – deviation (e_i) and FOM.....	31
Table 4-4.	Core average void fraction – Exelon and deviation.....	34
Table 4-5.	Core average void fraction FOM.....	35
Table 4-6.	Vessel dome pressure FOM – participant vs. measured data (5 seconds)	37
Table 4-7.	Vessel dome pressure FOM – participant vs. measured data (1.5 seconds)	39
Table 4-8.	Core exit pressure FOM – participant vs. Exelon data (5 seconds).....	41
Table 4-9.	Core exit pressure FOM – participant vs. Exelon data (1.5 seconds).....	43
Table 4-10.	Jet pump flow rate FOM – participant vs. Exelon data (5 seconds)	45
Table 4-11.	Jet pump flow rate FOM – participant vs. Exelon data (1.5 seconds)	47
Table 4-12.	Core in-channel flow rate FOM – participant vs. Exelon data (5 seconds)	49
Table 4-13.	Core in-channel flow rate FOM – participant vs. Exelon data (1.5 seconds)	51
Table 4-14.	Steam bypass flow rate FOM – participant vs. Exelon data (5 seconds).....	53
Table 4-15.	Steam bypass flow rate FOM – participant vs. Exelon data (1.5 seconds).....	55
Table 4-16.	Turbine inlet pressure FOM – participant vs. averaged data (5 seconds).....	57
Table 4-17.	Turbine inlet pressure FOM – participant vs. averaged data (1.5 seconds).....	57
Table 4-18.	Sequence of events	59
Table 4-19.	Time of the maximum peak.....	59
Table 4-20.	Maximum peak value (delta changes)	60
Table A-1.	TEPSYS reference numerical options in ENTRÉE and valve parameters	79
Table B-1.	UPISA steam line and bypass system geometrical data	123
Table B-2.	UPISA decay constant and fractions of delayed neutrons	125

List of Abbreviations

1-D	One-Dimensional
2-D	Two-Dimensional
3-D	Three-Dimensional
ACAP	Automated Code Assessment Program
APRM	Average Power Range Monitor
AVZ	Above Vessel Zero
BC	Boundary Conditions
BE	British Energy
BOC	Beginning of Cycle
BP	Burnable Poison
BPV	Bypass Valve
BVBO	Bypass Valve Begins Opening
BVFO	Bypass Valve Full Open
BWR	Boiling Water Reactor
CA	Control Assembly
CEA	Commissariat à l'Énergie Atomique
CEPIR	Core Exit Pressure Initial Response
DPIR	Dome Pressure Initial Response
EOC	End of Cycle
EOT	End of Transient
EPRI	Electric Power Research Institute
Exelon	Exelon Nuclear
FA	Fuel Assembly
FANP	FRAMATOME ANP
FFT	Fast Fourier Transform
FOM	Figure of Merit
FZR	Forschungs Zentrum Rossendorf
GE	General Electric
GRS	Gesellschaft für Anlagen- und Reaktorsicherheit mbH
HFP	Hot Full Power
HZP	Hot Zero Power
LPRM	Local Power Range Monitor
LWR	Light Water Reactor
ME	Mean Error
MSIV	Main Steam Isolation Valve
MSLB	Main Steam Line Break
MVCEP	Maximum Value Percent Initial Value of Core Exit Pressure
NEA	Nuclear Energy Agency

NEM	Nodal Expansion Method
NETCORP	Nuclear Engineering Technology Corporation
NFI	Nuclear Fuel Industries Ltd.
NP	Normalised Power
NPP	Nuclear Power Plant
NRC	US Nuclear Regulatory Commission
NRS	Nuclear Reactor Systems
NSC	Nuclear Science Committee
NSSS	Nuclear Steam Supply System
NUPEC	Nuclear Power Engineering Corporation
OECD	Organisation for Economic Co-operation and Development
PB	Peach Bottom Atomic Power Station
PB2	Peach Bottom Atomic Power Station Unit 2
PECo	Philadelphia Electric Company
PSI	Paul Scherrer Institute
PSU	Pennsylvania State University
PWR	Pressurised Water Reactor
SRV	Safety Relief Valve
TEPSYS	TEPCO Systems Corporation
T-H	Thermal-Hydraulic
TSV	Turbine Stop Valve
TSVC	Turbine Stop Valve Closing
TT	Turbine Trip
TT2	Turbine Trip Test 2
UPISA	University of Pisa
UPV	Universidad Politecnica de Valencia
VBA	Visual Basic for Applications
WES	Westinghouse Atom AB

Chapter 1
INTRODUCTION

Prediction of a nuclear power plant's behaviour under both normal and abnormal conditions has important ramifications for safety and economic operations. Such prediction is only possible using highly sophisticated computer codes given the complexity of nuclear power plants. Incorporation of full three-dimensional (3-D) models of the reactor core into system transient codes allows for a "best-estimate" calculation of interactions between core behaviour and plant dynamics. Recent progress in computer technology has made the development of such coupled code systems (thermal-hydraulic and neutron kinetics) feasible. Considerable effort has been made by various countries and organisations in this direction. In order to verify the capability of the coupled codes for the analysis of complex transients with coupled core-plant interactions and to fully test thermal-hydraulic coupling, appropriate light water reactor (LWR) transient benchmarks need to be developed on a higher best-estimate level. Previous sets of transient benchmark problems separately addressed system transients (designed mainly for thermal-hydraulic system codes with point kinetics models) and core transients (designed for thermal-hydraulic core boundary condition models coupled with a 3-D neutron kinetics model). The Nuclear Energy Agency (NEA) of the Organisation for Economic Co-operation and Development (OECD) has recently completed, under the sponsorship of the US Nuclear Regulatory Commission (NRC), a PWR Main Steam Line Break (MSLB) benchmark [1] against coupled thermal-hydraulic and neutron kinetics codes.

A benchmark team from The Pennsylvania State University (PSU) was responsible for developing the benchmark specifications, assisting the participants and co-ordinating the benchmark activities. The benchmark was well-received by the international community. The participants of the PWR MSLB benchmark felt that there should be a similar benchmark against the codes for a BWR plant transient. A turbine trip (TT) transient in a BWR is a pressurisation event in which the coupling between core phenomena and system dynamics plays an important role. In addition, the available real plant experimental data [3-5] makes such a benchmark problem quite valuable. The NEA, OECD and US NRC have approved the BWR TT benchmark for the purpose of validating advanced-system best-estimate analysis codes.

As a result, a benchmark project has been established in order to test the coupled system (thermal-hydraulic/neutron kinetics) codes by modelling a PB2 (a GE-designed BWR/4) turbine trip transient with a sudden closure of the turbine stop valve. Three turbine trip transients at different power levels were performed at the Peach Bottom (PB2) BWR/4 nuclear power plant (NPP) prior to shutdown for refuelling at the end of Cycle 2 in April 1977. The second test was selected for the benchmark to investigate the effect of the pressurisation transient (following the sudden closure of the turbine stop valve) on the neutron flux in the reactor core. In a best-estimate manner the test conditions approached the design basis conditions as much as possible. The actual data were collected, including a compilation of reactor design and operating data for Cycles 1 and 2 of PB, as well as the plant transient experimental data. The transient was selected for this benchmark because it is a dynamically complex event for which neutron kinetics in the core were coupled with thermal-hydraulics in the reactor primary system.

The purposes of this benchmark are met through the application of three exercises, which are described in Volume 1 of the OECD/NRC BWR TT Benchmark – Final Specifications [2]. The purpose of the first exercise is to test the thermal-hydraulic system response and to initialise the participants' system models. Core power response is provided to reproduce the actual test results, using either power or reactivity versus time data. The second exercise has two steady state conditions – hot zero power (HZP) conditions and initial conditions of TT2. The purpose of Exercise 2 is to provide a clean initialisation of the coupled core models since the core thermal-hydraulic boundary conditions are provided. The last exercise, Exercise 3, is the best estimate for coupled 3-D core/thermal-hydraulic system modelling. This exercise combines elements of the first two exercises of this benchmark and is an analysis of the transient in its entirety. Exercise 3 also includes extreme scenarios, which provide the opportunity to better test the code coupling and feedback modelling.

The following chapters are based on the comparative analysis of the submitted results for Exercise 1. In total, fourteen results were submitted by participants representing fourteen organisations from eight countries. A list of participants, who submitted results to the PSU benchmark team for the first exercise, along with the codes used to perform the analysis, is located in Table 1-1. A more detailed description of each code is presented in Appendix A and the modelling assumptions made by each participant are given in Appendix B.

Chapter 2 contains a description of Exercise 1, including the initial conditions. Chapter 3 discusses the utilised comparative statistical methodology for integral parameters, one-dimensional (1-D) values and time histories. Chapter 4 provides a comparative analysis of the final results for this first exercise. Finally, Chapter 5 provides a brief summary of the conclusions drawn from the analysis of Exercise 1.

Table 1-1. List of participants in Exercise 1 of the BWR TT benchmark

Participant number	Company name	Code	Country
1	CEA	CATHARE V15A/Mod2.1	France
2	Exelon	RETRAN	USA
3	FANP	S-RELAP5 V3.1.1	Germany
4	GRS	ATHLET	Germany
5	NETCORP	DNB-3D	USA
6	NFI	TRAC-BF1	Japan
7	NUPEC	TRAC-BF1	Japan
8	PSI	RETRAN-3D	Switzerland
9	PSU	TRAC-BF1	USA
10	PSU/NRC	TRAC-M	USA
11	TEPSYS	TRAC-BF1	Japan
12	UPISA	RELAP5/Mod3.3	Italy
13	UPV	TRAC-BF1	Spain
14	Westinghouse	POLCA-T	Sweden

Chapter 2

DESCRIPTION OF EXERCISE 1

2.1 General

The first exercise consists of performing a system thermal-hydraulic calculation (no neutron kinetics model involved; core power or reactivity as a function of time is provided as an input) for the PB2 TT transient. The purpose of the first exercise is to test the thermal-hydraulic system response and to initialise the participants' system models. This approach is used to develop/refine key sub-models of steam lines, steam bypass systems, jet pumps, steam separators and the upper downcomer region where a distinct steam-water interface exists.

2.2 Description of turbine trip scenario

The Peach Bottom Unit 2 Turbine Trip Test 2 starts with a sudden closure of the turbine stop valve (TSV) followed by the opening of the turbine bypass valve. From a fluid-flow phenomena point of view, pressure and flow waves play an important role during the early phase of the transient. This is because rapid valve actions cause sonic waves, as well as secondary waves, which are generated in the pressure vessel. The pressure oscillation generated in the main steam piping propagates with relatively little attenuation into the reactor core. The induced core pressure oscillation results in changes to the core void distribution and fluid flow. The magnitude of the neutron flux transient in the BWR core is affected by the initial rate of pressure rise (caused by pressure oscillation) and has spatial variation. The simulation of the power response to the pressure pulse and subsequent void collapse requires a 3-D core modelling supplemented by a 1-D simulation of the remainder of the reactor coolant system.

A TT transient in a BWR-type reactor is considered one of the most complex events to be analysed because it involves the reactor core, the high pressure coolant boundary, associated valves and piping in highly complex interactions with rapidly changing variables.

As mentioned earlier, the transient begins with a sudden TSV closure that initiates a pressure wave in the main steam system, which is quickly transmitted to the reactor pressure vessel. While the TSVs are closing, the bypass system valves are designed to open, which allows for steam release and, thus, pressure relief. Safety relief valves (SRVs) begin to open at pre-established set points, providing additional pressure relief. The pressure wave requires a detailed nodalisation modelling of the steam system and its associated valves to assure that timing effects and pressure wave magnitude can be accurately determined. This assures the availability of a pressure history on each valve, allowing adequate modelling of steam flow through the valves.

2.3 Initial steady state conditions

The reference design for the BWR is derived from real reactor, plant and operation data for the PB2 NPP and it is based on the information provided in the EPRI reports [3-6] as well as some additional sources such as the PECo Energy Topical report [7].

Peach Bottom Atomic Power Station Unit 2 is a GE-designed BWR/4 with a rated thermal power of 3 293 MW, a rated core flow of 12 915 kg/s (102.5×10^6 lb/hr), a rated steam flow of 1 685 kg/s (13.37×10^6 lb/hr) and a turbine inlet pressure of 6.65 MPa (965 psia). The nuclear steam supply system (NSSS) has turbine-driven feed pumps and a two-loop M-G driven recirculation system, feeding a total of 20 jet pumps. In total, there are four steam lines and each has a flow-limiting nozzle, main steam isolation valves (MSIVs), safety relief valves and a turbine stop valve. The steam bypass system consists of nine bypass valves (BPVs) mounted on a common header, which is connected to each of the four steam lines.

There are 764 fuel bundles with an active fuel length of 365.76 cm (12 ft) in the core region. The fuel bundles consist of 576 original 7×7 fuel bundles with P/D (pitch/outer diameter) equal to 1.87452 cm/1.43002 cm (0.738 in/0.563 in) and 188 partially reloaded 8×8 fuel bundles with P/D equal to 1.62560 cm/1.25222 cm (0.640 in/0.493 in). Additionally, the core region includes 185 control rods (CRs). For the reactor protection system (RPS), control systems for reactor pressure, recirculation flow, feedwater flow and reactor water level are commonly used in reactors of this design.

Turbine trip test 2 (TT2) was initiated from steady state conditions after obtaining P1 edits from the process computer for nuclear and thermal-hydraulic conditions of the core. PB2 was chosen for the turbine trip tests because it is a large BWR/4 with relatively small turbine bypass capacity. At the beginning of the test, the initial thermal power level was 61.6% of nominal power (2 030 MW); core flow was 80.9% of nominal flow rate (10 445 kg/s, 82.9×10^6 lb/hr); and average power range monitor (APRM) scram set point was 95% of nominal power. (PBTT benchmark participants used the control rod insertion time of 0.75 seconds [s] in all exercises.) For the TT2 test, the dynamic measurements were taken with a high-speed digital data acquisition system capable of sampling over 150 signals every 6 milliseconds (ms) and the core power distribution measurements were taken from the plant's local in-core flux detectors. Special fast-response pressure and differential pressure transducers were installed in parallel with the existing plant instruments in the nuclear steam supply system. Table 2.3-1 provides the reactor initial conditions for performing steady state calculations.

Table 2.3-1. PB2 TT2 initial conditions from process computer P1 edit

Core thermal power (MWt)	2 030
Initial power level (% of rated)	61.6
Gross power output (MWe)	625.1
Feedwater flow (kg/s)	980.26
Reactor pressure (Pa)	6 798 470.0
Total core flow (kg/s)	10 445.0
Core inlet sub-cooling (J/kg)	48 005.291
Feedwater temperature (K)	442.31
Core pressure drop (Pa)	113 560.7
Jet pump driving flow (kg/s)	2 871.24*
Core average exit quality (fraction)	0.097
Core average void fraction (fraction)	0.304

* Corrected for calibration and conversion errors

The initial water level above vessel zero (AVZ) was equal to 14.1478 m (557 in). This measured level was the actual level inside the steam dryer shroud. The initial level AVZ was equal to 14.3256 m (564 in) for the narrow range measurement outside the steam dryer shroud. AVZ was the lowest interior elevation of the vessel (bottom of lower plenum). Table 2.3-2 and Figure 2.3-1 provide the process computer P1 edit for the initial core relative axial power distribution to be used in Exercise 1.

Table 2.3-2. PB2 TT2 initial core average axial power distribution from P1 edit

Axial node number	Axial location (cm)	Relative power
1	7.62	0.308051
2	22.86	0.616103
3	38.10	0.707754
4	53.34	0.773947
5	68.58	0.814681
6	83.82	0.880874
7	99.06	0.972526
8	114.30	1.066723
9	129.54	1.163467
10	144.78	1.260210
11	160.02	1.356953
12	175.26	1.407871
13	190.50	1.412963
14	205.74	1.402779
15	220.98	1.377320
16	236.22	1.328949
17	251.46	1.257664
18	266.70	1.188925
19	281.94	1.122733
20	297.18	1.031081
21	312.42	0.913971
22	327.66	0.763764
23	342.90	0.580460
24	358.14	0.290230

Figure 2.3-1. PB2 TT2 initial core axial average power distribution from P1 edit

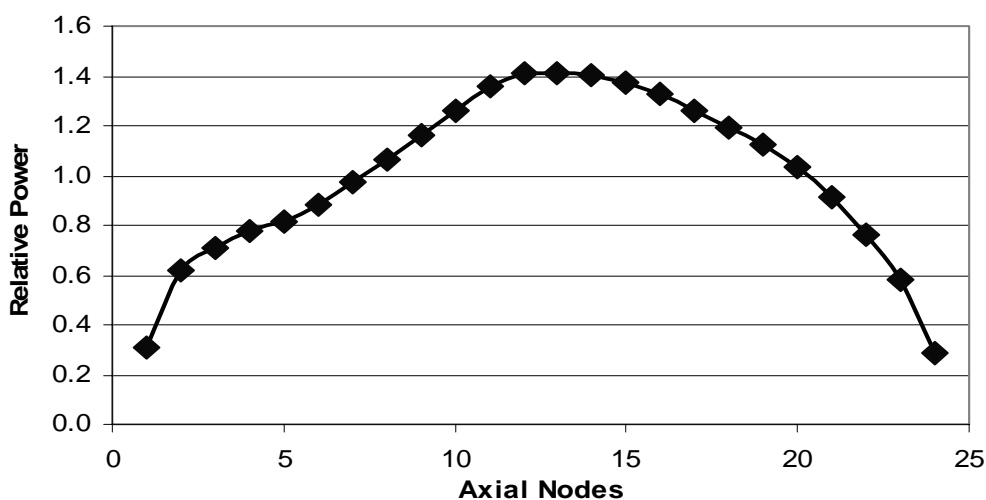

2.4 Transient calculations

During the TT2 test, most of the important phenomena occur in the first five seconds of the transient since it is a fast transient. For the purpose of the benchmark, the transient is required to be simulated for a five-second time period. This approach simplifies the number of components required for performing the analysis of TT2. The transient begins with the closure of the TSV. At some point in time, the turbine BPV begins to open. The only boundary conditions imposed on the analysis should be limited to the opening and closure of the above valves. Also, it should be noted that during the simulation of Exercise 1, the set points of the SRVs are never reached. Since there is no neutron kinetics model utilised in Exercise 1, the scram is not simulated explicitly. Rather, it is accounted for implicitly in the provided power (or reactivity) time history to be used for this exercise. Table 2.4-1 shows the experimental time sequence of events during the transient.

Table 2.4-1. PB TT2 event timing (time in milliseconds)

TSV begins to close	0
TSV closed	96
Begins bypass opening	60
Bypass fully open	846
Turbine pressure initial response	–
Steam line A	102
Steam line D	126
Steam line pressure initial response	–
Steam line A	348
Steam line D	378
Vessel pressure initial response	432
Core exit pressure initial response	486

Chapter 3

METHODOLOGIES FOR COMPARATIVE ANALYSIS

As mentioned in Chapter 1, each of the 14 participants submitted various data that were available for statistical analysis. The submitted results were categorised by nature of the data. For Exercise 1, the categories were: integral parameter values, 1-D distributions and time histories.

In addition, the submitted data could be distinguished according to the reference data used in the comparative analysis. The reference data used in the Exercise 1 comparative analysis were called: measured data, Exelon data and averaged data.

Measured data is the set of original recorded data during the second turbine trip transient test. In the case of unavailable measured data, Exelon results (so-called Exelon data) were used as reference results for the comparison. The main reason for this approach is that the Exelon results were already extensively validated with the measured data. In other words, the Exelon data agree quite well with the measured data and this agreement was published in the PECo Topical Report, which was submitted to US NRC [7]. It should be noted that the current operator of PB2 NPP is Exelon Nuclear. The former operator, the Philadelphia Electric Company (PECo), recently merged with Exelon Nuclear. In the event of a lack of measured data and/or Exelon data for a given parameter, the reference solution for each requested parameter is based on the statistical mean value (so-called averaged data) of all submitted results.

3.1 Standard techniques for the comparison of results

In Exercise 1 of this benchmark, several types of data were analysed and the results of all participants were compared. The data types were:

- Integral parameter values.
- One-dimensional (1-D) axial distributions.
- Time histories.

It was necessary to develop a suite of statistical methods for each of these data types, which were applied in the comparative analysis. What follows is a description of each of these methods.

3.1.1 *Integral parameter values*

These parameters include such values as core inlet enthalpy and core average pressure drop for initial steady state conditions. Since measured data exist for both core inlet enthalpy and core average pressure drop, standard deviation and figure of merit (FOM) are calculated in Eqs. (3.1-3.3).

$$\sigma = \pm \sqrt{\frac{\sum (x_i - x_{Measured})^2}{N - 1}} \quad (3.1)$$

where σ is the standard deviation, x_i is the data submitted by each participant and N is the total number of received results.

The FOM is computed as follows:

$$\Phi_i = e_i / \sigma \quad (3.2)$$

$$e_i = x_i - x_{Measured} \quad (3.3)$$

where e_i is the deviation for each participant result.

3.1.2 One-dimensional (1-D) axial distributions

Exercise 1 compared only one 1-D axial distribution, which was the core average axial void fraction distribution. The core average axial void fraction distribution is a function of height or number of axial nodes, and it can be displayed as an x-y plot. Similar methods of statistical analysis described in the previous section could be applied for each axial cell, the only difference being the reference data. In this case and in the event of a lack of measured data, the Exelon data were taken as reference for the comparison. Analyses were performed for each 1-D cell according to Eqs. (3.4-3.6):

$$\sigma = \pm \sqrt{\frac{\sum (x_i - x_{Exelon})^2}{N - 1}} \quad (3.4)$$

where x_i is each participant's data and N is the total number of received results. FOM is computed as:

$$\Phi_i = e_i / \sigma \quad (3.5)$$

$$e_i = x_i - x_{Exelon} \quad (3.6)$$

For each participant, a table was prepared that shows the deviations from mean and FOM at each axial position.

3.1.3 Time histories

Six different sets of time histories were submitted by the participants for Exercise 1. The submitted time histories included: dome pressure, core exit pressure, jet pump flow rate, core in-channel flow rate, steam bypass flow rate and turbine inlet pressure. The reference data for dome pressure comparison was the measured data. Since Exelon data were available for core exit pressure, jet pump flow rate, core in-channel flow rate and steam bypass flow rate, the comparisons were based on the Exelon data. It should be noted that for some of these categories there were measured data. However, the quality of this data (oscillating time histories) was not appropriate and the oscillatory behaviour of the data needed to be smoothed. The Exelon results show perfect agreement with the smoothed measured data. Due to the lack of measured and Exelon data, the statistical mean value of the submitted turbine pressure results (also called averaged data) was used as reference. The averaged data were calculated according to the equation that follows.

$$\bar{x} = \frac{\sum_{i=1}^N x_i}{N} \quad (3.7)$$

where x_i is each participant's value for specified time interval and N is total number of received results.

3.2 ACAP analysis

The comparative analysis was performed for code-to-data and code-to-code comparisons using the standard statistical methodology with the Automated Code Assessment Program (ACAP) [8]. ACAP is a tool developed to provide quantitative comparisons between nuclear reactor system code results and experimental measurements. This software was developed under a contract with PSU and the NRC for use in PSU's code consolidation efforts. ACAP's capabilities are described as follows:

- Draws upon a mathematical toolkit to compare experimental data and NRS code simulations.
- Returns quantitative FOMs associated with individual and suite comparisons.
- Accommodates the multiple data types encountered in NRS environments.
- Incorporates experimental uncertainty in the assessment.
- Provides "event windowing" capability.
- Accommodates inconsistencies between measured and computed independent variables (e.g. different time steps).
- Provides a framework for automated, tuneable weighting of component measures in the construction of overall FOM accuracy.

ACAP is a PC and UNIX station-based application that can be run interactively on PCs with Windows 95/98/NT, in batch mode on PCs as a Windows console application, or in batch mode on UNIX stations as a command line executable.

The D'Auria Fast Fourier Transformation (FFT) and Mean Error (ME) methods were used in FOM calculations for time histories [8,11]. Figure 3.2-1 shows a snapshot of the FOM configuration for ACAP calculations in Exercise 1 of the benchmark. These methods are advanced techniques for analysis of time history data. Eqs. (3.8-3.13) represent the theory portion of the D'Auria FFT and ME methods.

Figure 3.2-1. FOM configuration in ACAP

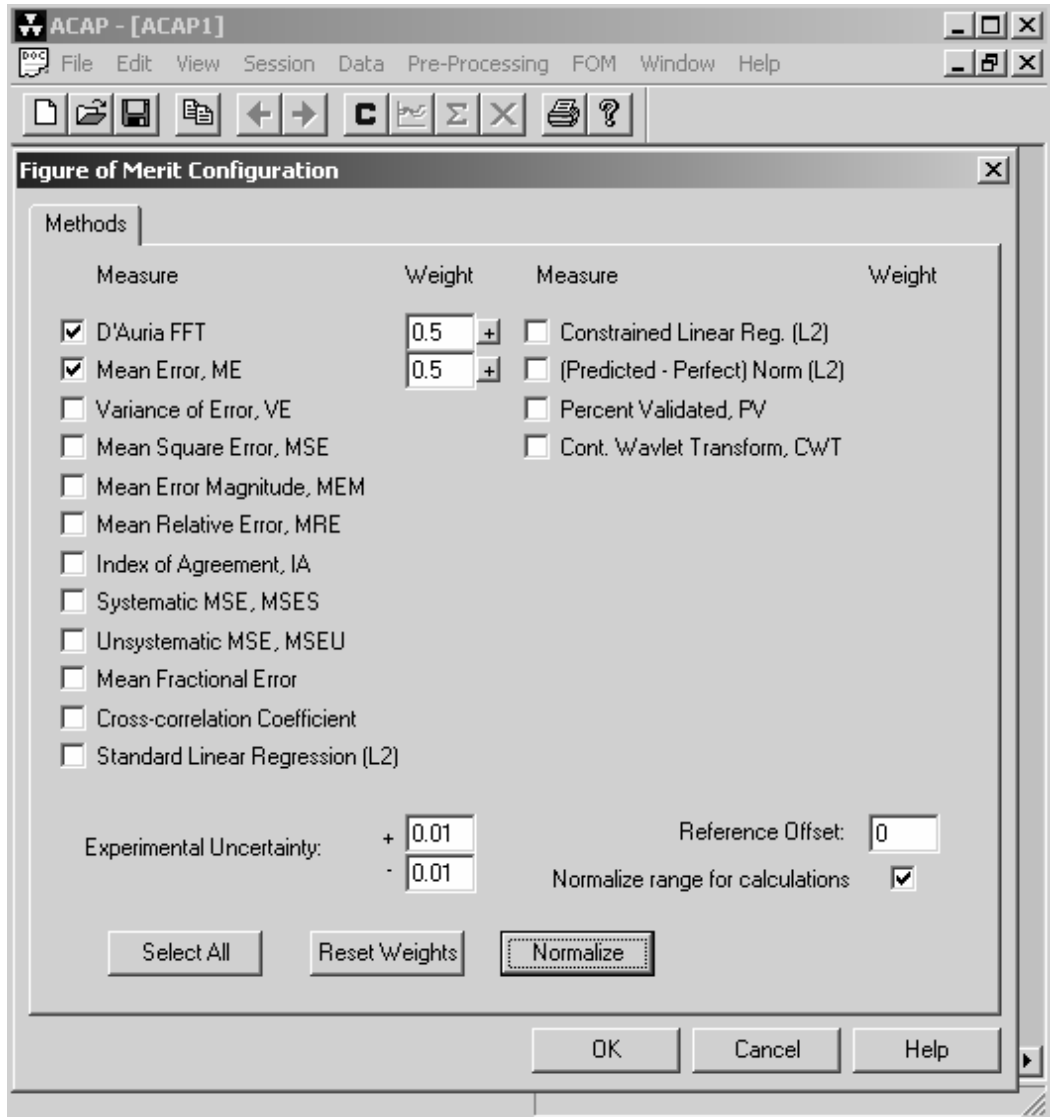

The Discrete Fourier Transform (DFT) can be calculated as:

$$\hat{\Phi}_m = \frac{1}{N} \sum_{i=1}^N \Phi_i e^{-2\pi Imi/N} \quad (3.8)$$

The D'Auria measures are as follows:

- Average amplitude (AA)

$$AA = \frac{\sum_{m=0}^M |\hat{P}_m - \hat{O}_m|}{\sum_{m=0}^M |\hat{O}_m|} \quad (3.9)$$

- Weighted frequency (WF)

$$WF = \frac{\sum_{m=0}^M |\hat{P}_m - \hat{O}_m| \cdot f_m}{\sum_{m=0}^M |\hat{P}_m - \hat{O}_m|} \quad (3.10)$$

where N is the number of data values, i is the sample index, Φ_i is the value spaced Δt apart, O_i is the i^{th} datum in the experimental set, P_i is the i^{th} datum in the computed set, and f_m is the frequency of mode m .

Mean error can be computed as:

$$ME = \frac{1}{N} \left\{ \sum_{i=1}^N (O_i - P_i) \right\} \quad (3.11)$$

The D' Auria and ME FOM equations are outlined below:

$$FOM_{D'Auria} = \frac{1}{\left(\left[AA^2 + \left(\frac{K}{WF} \right)^2 \right]^{1/2} + 1 \right)} \quad (3.12)$$

where K is the constant used to weight the relative importance of the weighted frequency relative to the average amplitude.

$$FOM_{ME} = \frac{1}{(|ME| + 1)} \quad (3.13)$$

Please note that the statistical FOM given by Eqs. (3.2, 3.5) differs from the FOM calculated using Eqs. (3.12,3.13). FOM indicates that participant results are closer to the reference solution if the former FOM is closer to zero, while the latter FOM must be closer to unity (1) to indicate better agreement.

The following procedure was applied during the ACAP calculation:

Step 1 Data synchronisation was necessary due to the varying timesteps of submitted participant data for the time histories. Regarding synchronisation, the cubic spline function was written in Visual Basic for Applications (VBA) and a macro module was inserted into the Excel workbook file [9]. Then, all participant results were set to time intervals of precisely 6 ms. The inserted module is outlined in the text that follows.

```

Function cubic_spline(input_column As Range, output_column As Range, _x As Range)
Dim input_count As Integer
Dim output_count As Integer
input_count = input_column.Rows.Count
output_count = output_column.Rows.Count
If input_count <> output_count Then
    cubic_spline = "error"
    GoTo out
End If
ReDim xin(input_count) As Single
ReDim yin(input_count) As Single
Dim c As Integer
For c = 1 To input_count
xin(c) = input_column(c)
yin(c) = output_column(c)
Next c
Dim n As Integer
Dim i, k As Integer
Dim p, qn, sig, un As Single
ReDim u(input_count - 1) As Single
ReDim yt(input_count) As Single
n = input_count
yt(1) = 0
u(1) = 0
For i = 2 To n - 1
    sig = (xin(i) - xin(i - 1)) / (xin(i + 1) - xin(i - 1))
    p = sig * yt(i - 1) + 2
    yt(i) = (sig - 1) / p
    u(i) = (yin(i + 1) - yin(i)) / (xin(i + 1) - xin(i)) - (yin(i) - yin(i - 1)) / (xin(i) - xin(i - 1))
    u(i) = (6 * u(i) / (xin(i + 1) - xin(i - 1)) - sig * u(i - 1)) / p
Next i
qn = 0
un = 0
yt(n) = (un - qn * u(n - 1)) / (qn * yt(n - 1) + 1)
For k = n - 1 To 1 Step -1
    yt(k) = yt(k) * yt(k + 1) + u(k)
Next k
Dim klo, khi As Integer
Dim h, b, a As Single
klo = 1
khi = n
Do
k = khi - klo
If xin(k) > x Then
khi = k
Else
klo = k
End If
k = khi - klo
Loop While k > 1
h = xin(khi) - xin(klo)
a = (xin(khi) - x) / h
b = (x - xin(klo)) / h
y = a * yin(klo) + b * yin(khi) + ((a ^ 3 - a) * yt(klo) + (b ^ 3 - b) * yt(khi)) * (h ^ 2) / 6
cubic_spline = y
out:
End Function

```

Step 2 In order to avoid the effects of differing participant initialisation on the comparative analysis, actual values of the time history data were set to zero and they were called delta changes. The delta changes were calculated by subtraction of initial value (at time zero) from all other values (as shown below) where t represents time.

Delta changes (t = 0.000) = value (t = 0.000) – value (t = 0.000)
Delta changes (t = 0.006) = value (t = 0.006) – value (t = 0.000)
Delta changes (t = 0.012) = value (t = 0.012) – value (t = 0.000)
Delta changes (t = 0.018) = value (t = 0.018) – value (t = 0.000)
Delta changes (t = 0.024) = value (t = 0.024) – value (t = 0.000)
Delta changes (t = 0.030) = value (t = 0.030) – value (t = 0.000)
Delta changes (t = 0.036) = value (t = 0.036) – value (t = 0.000)
Delta changes (t = 0.042) = value (t = 0.042) – value (t = 0.000)
Delta changes (t = 0.048) = value (t = 0.048) – value (t = 0.000)
...

Step 3 The ACAP input file should be prepared properly and loaded to ACAP. Below is a simplified example of an ACAP data file.

sync 1	this is synchronised data
title data	MEASURED:
title data	CEA:
title data	FRA:
title data	GRS:
title data	IBE:
title data	NET:
title data	NFI:
title data	NUP:
title data	PSI:
title data	PSU:
title data	PSU/NRC:
title data	TEP:
title data	U.PISA:
title data	UPV:
title data	WES:
data	
	0 0.000000
	0.006 0.005516
	0.012 0.005516
	0.018 0.000000
	...
data	
	0 0.000000
	0.006 0.000000
	0.012 0.000000
	0.018 0.000001
	...
data	
	0 0.000000
	0.006 0.000000
	0.012 0.000000
	0.018 0.000000
	...
...	

Step 4 Using ACAP’s user friendly interactive options, a configuration must be selected and the FOM calculation should be performed in accordance with the reference data.

Chapter 4

RESULTS AND DISCUSSION OF EXERCISE 1

The tables and figures in this chapter provide a comparison of participant results with the reference solution for the parameters that have the greatest effect on the initial steady state and transient scenario. The tables show values of standard deviation and figure of merit (as defined in Chapter 3) for each participant result and for a given parameter. This chapter contains figures that show the scatter of data around the reference solution.

Participant models used in Exercise 1 are presented in Table 4-1. This table is categorised by usage of bypass model, decay heat and power model as well as by the number of core channels in the participant system models. Core inlet enthalpy, core average pressure drop and core averaged axial void fraction distribution are the selected parameters for steady state comparisons in this exercise. For these parameters, Figures 4-1 through 4-6 graphically illustrate the agreement or disagreement of participant predictions. Tables 4-2 through 4-5 show values, deviations and figures of merit for each participant result and given parameter.

In the transient analysis, reactor vessel dome pressure, core exit pressure, jet pump flow rate (total core flow rate), core in-channel flow rate, steam bypass flow rate (turbine bypass flow rate) and turbine inlet pressure are the selected time histories for Exercise 1 comparisons. Time histories were analysed for two different time intervals, which were 5 seconds and 1.5 seconds. Since this transient is a very fast one, the study focused on the initial 1.5 s period after performing the analysis on the 5 s period. Figures 4-7 through 4-40 compare the participant results with the reference solutions for each parameter. Reference solutions are also compared with the averaged values of participant results. In addition, Tables 4-6 through 4-17 show the ACAP FOM results for each parameter.

Although each of the 5 s time histories consisted of 833 data points and each of the 1.5 s time histories consisted of 250 data points, few of these data points were marked in the figures. One marker for each 50 points (for each 0.3 s time interval) was shown on the figures in order to make the figures legible. For this purpose, a macro module was written in VBA for the Excel workbooks.

Participant marker types, marker frequencies and the thickness/colour of lines were unique and consistent for all time history figures. For instance, the reference data (measured, Exelon or averaged) were always illustrated with the marker . Part of the macro module is subsequently shown.

Exercise 1 – Macro module

```
Sub Macro_Marker71()  
' Macro_Marker71 Macro  
' Macro recorded 10/2/2003 by rdfmg  
ActiveChart.SeriesCollection(1).Select  
ActiveChart.SeriesCollection(1).Points(50).Select  
With Selection.Border  
    .ColorIndex = 1  
    .Weight = xlMedium  
    .LineStyle = xlContinuous  
End With  
With Selection  
    .MarkerBackgroundColorIndex = 1  
    .MarkerForegroundColorIndex = 1  
    .MarkerStyle = xlSquare  
    .MarkerSize = 9  
    .Shadow = False  
End With  
ActiveChart.SeriesCollection(1).Select  
ActiveChart.SeriesCollection(1).Points(100).Select  
With Selection.Border  
    .ColorIndex = 1  
    .Weight = xlMedium  
    .LineStyle = xlContinuous  
End With  
With Selection  
    .MarkerBackgroundColorIndex = 1  
    .MarkerForegroundColorIndex = 1  
    .MarkerStyle = xlSquare  
    .MarkerSize = 9  
    .Shadow = False  
End With  
ActiveChart.SeriesCollection(1).Select  
ActiveChart.SeriesCollection(1).Points(150).Select  
With Selection.Border  
    .ColorIndex = 1  
    .Weight = xlMedium  
    .LineStyle = xlContinuous  
End With  
With Selection  
    .MarkerBackgroundColorIndex = 1  
    .MarkerForegroundColorIndex = 1  
    .MarkerStyle = xlSquare  
    .MarkerSize = 9  
    .Shadow = False  
End With  
ActiveChart.SeriesCollection(1).Select  
ActiveChart.SeriesCollection(1).Points(200).Select  
With Selection.Border
```

Exercise 1 – Macro module *continued*

```

.ColorIndex = 1
.Weight = xlMedium
.LineStyle = xlContinuous
End With
With Selection
.MarkerBackgroundColorIndex = 1
.MarkerForegroundColorIndex = 1
.MarkerStyle = xlSquare
.MarkerSize = 9
.Shadow = False
***continues for all desired data points and for all other figures
illustrated on the Excel chart***
End With
End Sub

```

Table 4-1. Participant models used in Exercise 1 of the BWR TT benchmark

Participants	Bypass model used?	Decay heat used?	Power model	Number of channels
CEA	Yes	No	Fission	1
Exelon	Yes	Yes	Fission	1
FANP	Yes	Yes	Fission	24
GRS	Yes	Yes	Fission	1
NFI	Yes	No	Fission	33
NUPEC	Yes	Yes	Fission	3
PSI	Yes	Yes	Fission	1
PSU	Yes	No	Fission	33
PSU/NRC	Yes	No	Fission	5
TEPSYS	Yes	Yes	Fission	33
UPISA	Yes	Yes	Fission	33
UPV	Yes	Yes	Fission	33
Westinghouse	Yes	No	Fission	764

This chapter also contains the participants’ sequence of events for the turbine trip transient in Table 4-18. In addition, the time of maximum peaks for time histories are presented in Table 4-19 and the maximum values of those peaks are given in Table 4-20.

Figure 4-1. Core inlet enthalpy

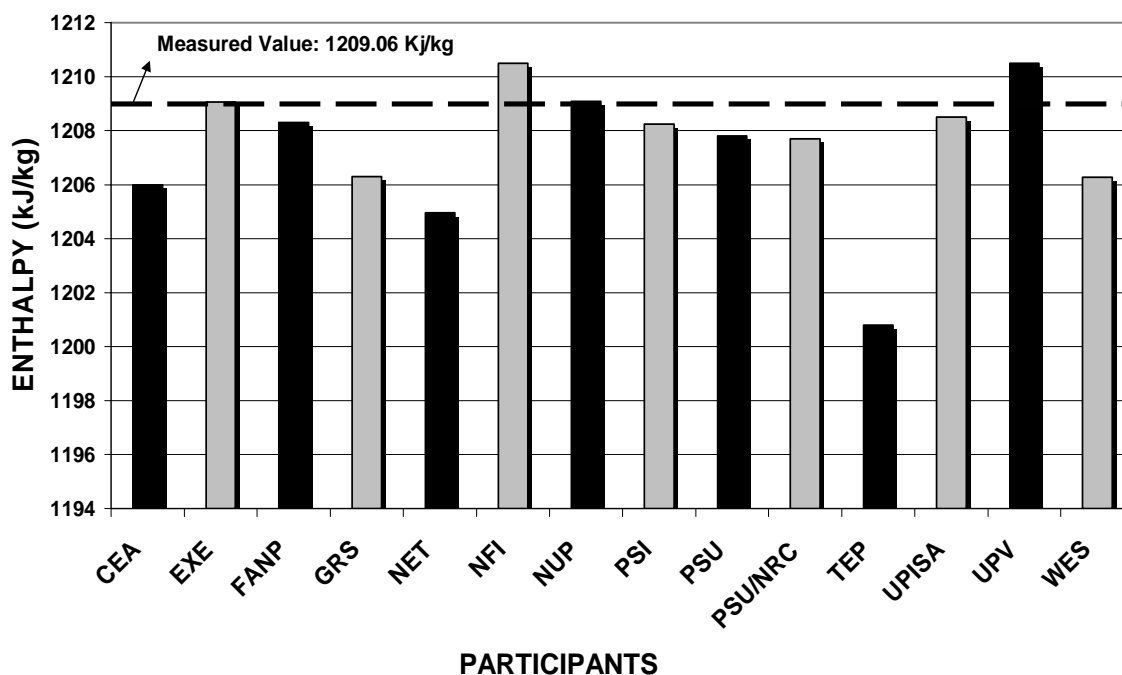

For core inlet enthalpy, key values are defined below.

Measured value: $x_{Measured} = 1\ 209.06\ \text{kJ/kg}$

Standard deviation:
$$\sigma = \pm \sqrt{\frac{\sum (x_i - x_{Measured})^2}{N - 1}} = \pm 3.023$$

Figure of merit: $\text{FOM} = e_i / \sigma$ where $e_i = x_i - x_{Measured}$

Table 4-2. Core inlet enthalpy – deviation (e_i) and FOM

	CEA	Exelon	FANP	GRS	NETCORP	NFI	NUP
Value	1 206.00	1 209.06	1 208.30	1 206.30	1 204.95	1 210.50	1 209.09
e_i (kJ/kg)	-3.060	0.000	-0.760	-2.760	-4.110	1.440	0.030
FOM	-1.012	0.000	-0.251	-0.913	-1.360	0.476	0.010
	PSI	PSU	PSU/ NRC	TEPSYS	UPISA	UPV	Westing- house
Value	1 208.24	1 207.80	1 207.70	1 200.80	1 208.50	1 210.49	1 206.27
e_i (kJ/kg)	-0.820	-1.260	-1.360	-8.260	-0.560	1.430	-2.790
FOM	-0.271	-0.417	-0.450	-2.732	-0.185	0.473	-0.923

Figure 4-2. Core pressure drop

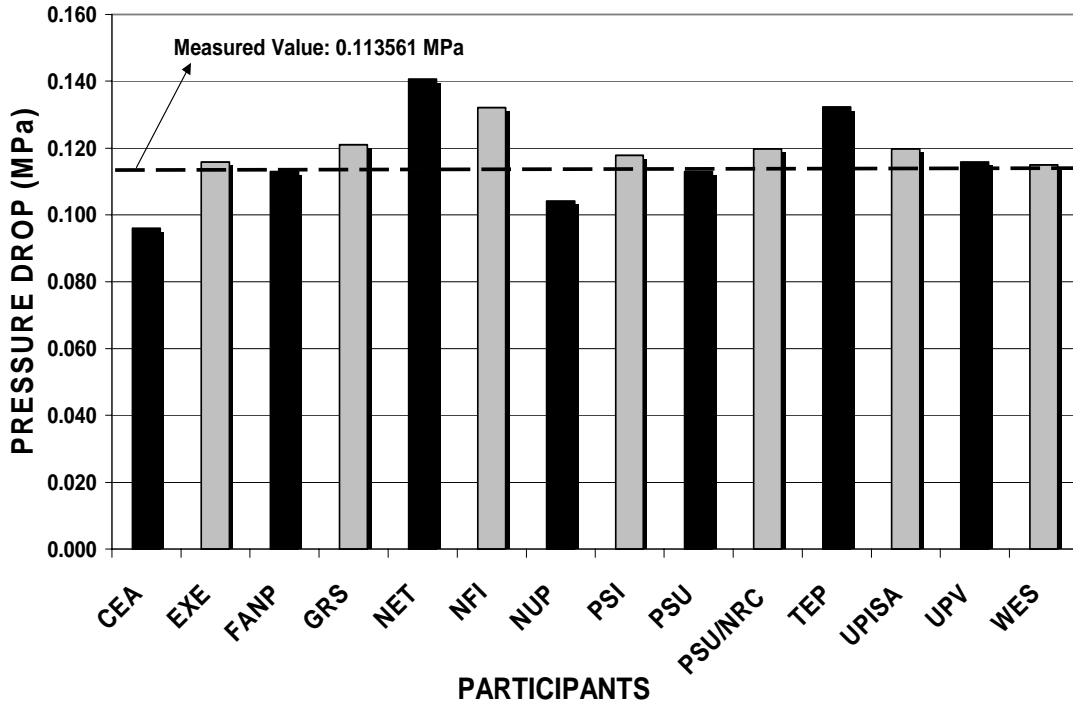

For core pressure drop, key values are defined below.

Measured value: $x_{Measured} = 0.113561$ MPa

Standard deviation: $\sigma = \pm \sqrt{\frac{\sum (x_i - x_{Measured})^2}{N - 1}} = \pm 0.012$

Figure of merit: $FOM = e_i/\sigma$ where $e_i = x_i - x_{Measured}$

Table 4-3. Core pressure drop – deviation (e_i) and FOM

	CEA	Exelon	FANP	GRS	NETCORP	NFI	NUP
Value	0.0960	0.1158	0.1130	0.1210	0.1406	0.1321	0.1041
e_i (MPa)	-0.018	0.002	-0.001	0.007	0.027	0.019	-0.009
FOM	-1.500	0.167	-0.083	0.583	2.250	1.583	-0.750
	PSI	PSU	PSU/ NRC	TEPSYS	UPISA	UPV	Westing- house
Value	0.1178	0.1130	0.1197	0.1322	0.1197	0.1159	0.1149
e_i (MPa)	0.004	-0.001	0.006	0.019	0.006	0.002	0.001
FOM	0.333	-0.083	0.500	1.583	0.500	0.167	0.083

Figure 4-3. Core average void fraction distribution

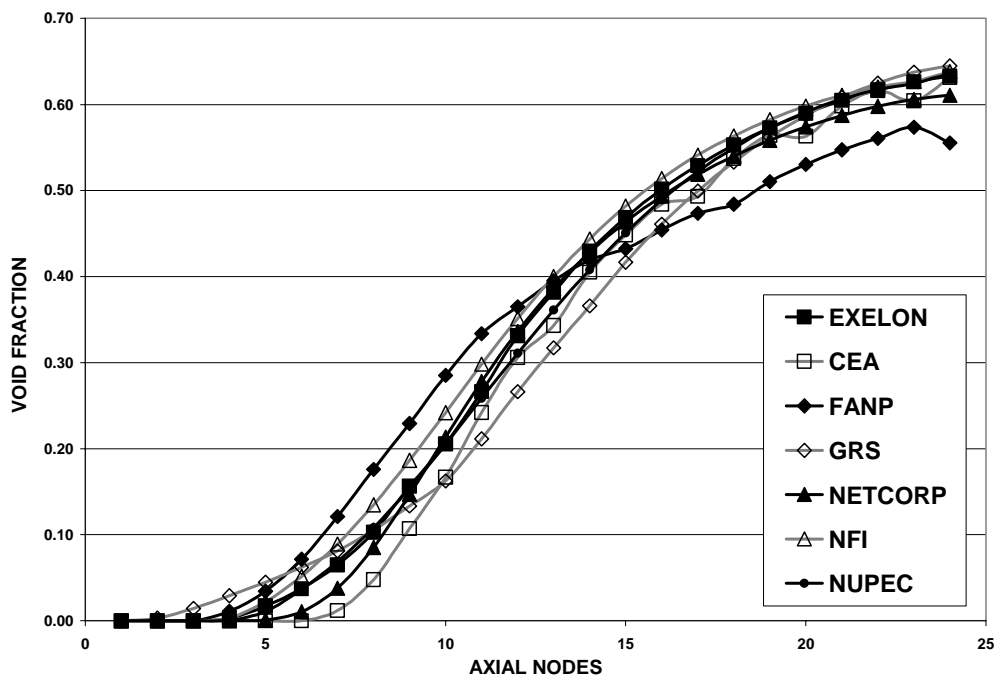

Figure 4-4. Core average void fraction distribution

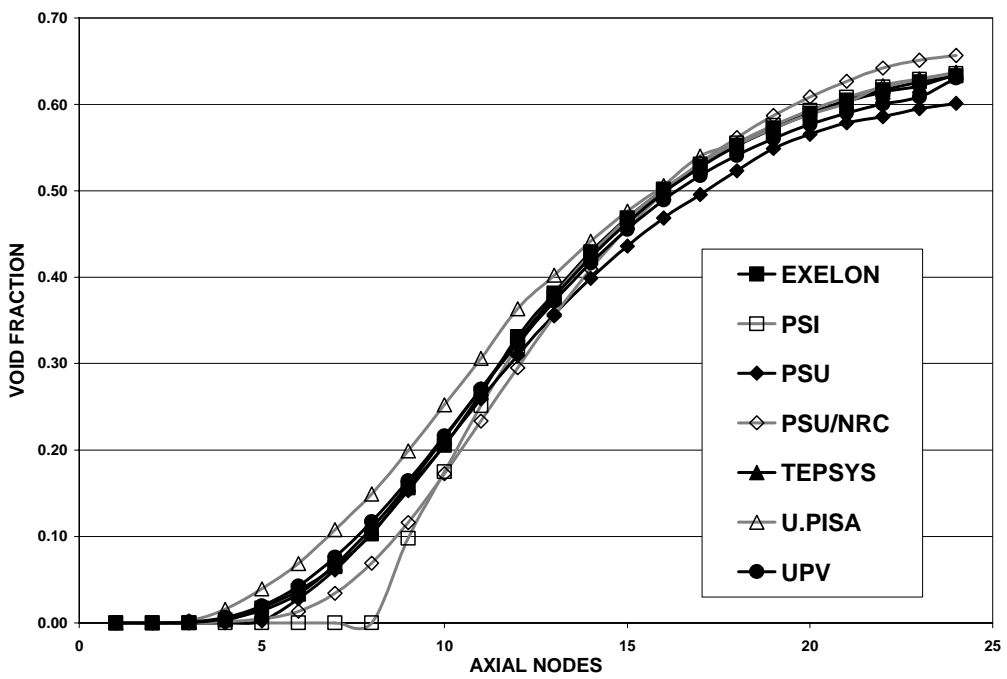

Figure 4-5. Void fraction distribution – averaged vs. Exelon data

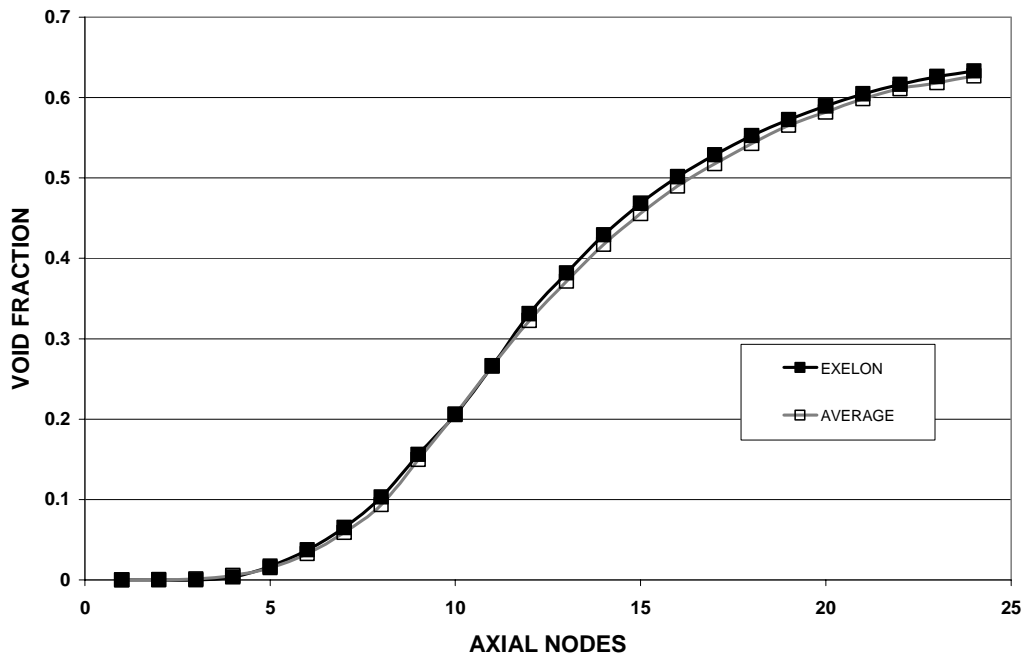

Figure 4-6. Void fraction distribution – Exelon and deviation

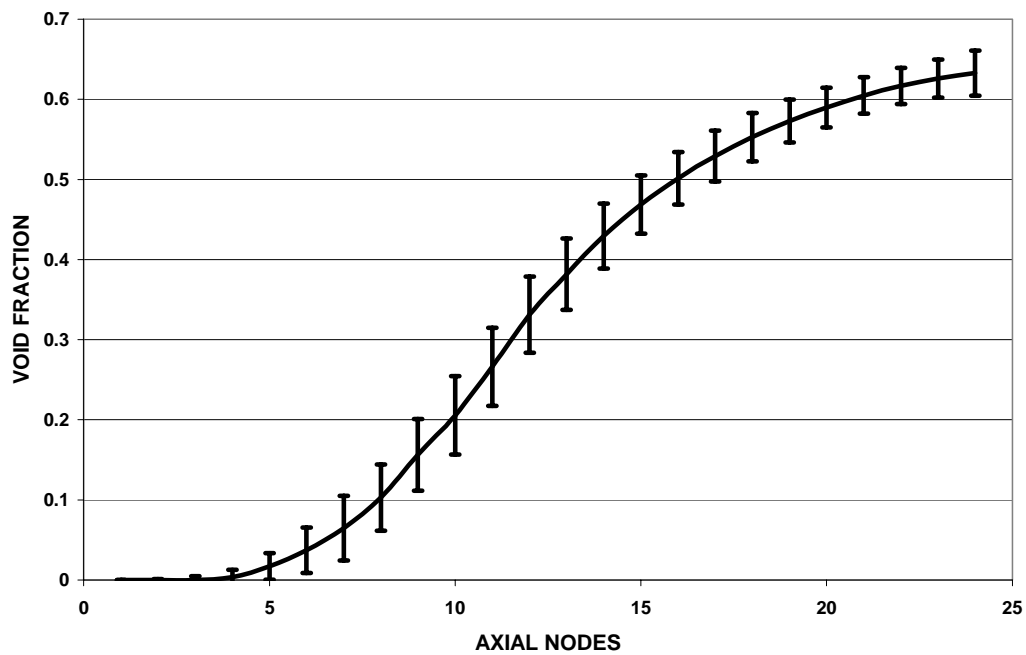

Table 4-4. Core average void fraction – Exelon and deviation

Axial nodes	Exelon	Deviation	Axial nodes	Exelon	Deviation
1	0	2.92E-05	13	0.3818	4.46E-02
2	0	9.60E-04	14	0.4294	4.04E-02
3	0	4.41E-03	15	0.4686	3.65E-02
4	0.0033	9.29E-03	16	0.5014	3.28E-02
5	0.0171	1.66E-02	17	0.5290	3.18E-02
6	0.0372	2.83E-02	18	0.5528	3.01E-02
7	0.0649	4.02E-02	19	0.5728	2.70E-02
8	0.103	4.11E-02	20	0.5898	2.47E-02
9	0.1562	4.46E-02	21	0.6047	2.28E-02
10	0.2055	4.89E-02	22	0.6167	2.25E-02
11	0.2661	4.88E-02	23	0.6261	2.36E-02
12	0.3312	4.76E-02	24	0.6329	2.82E-02

Table 4-5. Core average void fraction FOM

Nodes	CEA	FANP	GRS	NETCORP	NFI	NUP	PSI	PSU	PSU/ NRC	TEPSYS	UPISA	UPV
1	3.2877	0.0000	0.0000	0.0000	0.0427	0.0019	0.0000	0.0000	0.0000	0.0000	0.0000	0.4699
2	0.0407	0.0000	3.3042	0.0000	0.0004	0.0001	0.0000	0.0008	0.0000	0.0000	0.2915	0.0548
3	0.0047	0.0000	3.2721	0.0000	0.0301	0.0000	0.0000	0.0001	0.0000	0.0680	0.4952	0.2197
4	-0.3537	0.8611	2.7653	-0.3552	0.0043	-0.2801	-0.3552	-0.3552	-0.3552	0.1292	1.3349	0.3308
5	-1.0294	1.0422	1.6717	-0.9759	0.2978	-0.3718	-1.0301	-1.0301	-0.9561	-0.1687	1.3462	0.1436
6	-1.3141	1.2191	0.8866	-0.9435	0.5042	-0.0267	-1.3145	-1.2324	-1.1499	-0.1272	1.1091	0.1892
7	-1.3184	1.4030	0.4055	-0.6692	0.6063	0.1013	-1.6144	-0.9166	-1.2818	0.0572	1.0665	0.2749
8	-1.3455	1.7713	0.0535	-0.4282	0.7747	0.1244	-0.1261	-1.0093	-1.6776	0.1679	1.1277	0.3450
9	-1.1031	1.6390	-0.5112	-0.2085	0.6765	-0.0563	0.4180	-1.1764	-1.9536	0.0785	0.9629	0.1877
10	-0.7873	1.6278	-0.8793	0.1616	0.7442	-0.0090	0.9395	-1.0746	-1.8266	0.1820	0.9585	0.2251
11	-0.4939	1.3832	-1.1209	0.2439	0.6543	-0.1566	1.0958	-1.2335	-1.9168	0.0963	0.8180	0.0902
12	-0.5294	0.7122	-1.3634	0.1050	0.4242	-0.4287	0.9770	-1.5126	-2.0534	-0.1113	0.6835	-0.1654
13	-0.8700	0.3004	-1.4507	0.0964	0.4096	-0.4666	1.0119	-1.6221	-1.9377	-0.1054	0.4568	-0.2105
14	-0.6040	-0.2525	-1.5668	-0.0322	0.3557	-0.5348	0.9487	-1.7921	-1.8371	-0.1510	0.3066	-0.3139
15	-0.5644	-0.9890	-1.4301	-0.1397	0.3616	-0.4941	0.9161	-1.9078	-1.6197	-0.1425	0.2162	-0.3509
16	-0.5305	-1.4451	-1.2378	-0.2439	0.3848	-0.3838	0.8959	-1.9873	-1.3506	-0.1098	0.1452	-0.3673
17	-1.1321	-1.7484	-0.9277	-0.3270	0.3802	-0.2252	0.8310	-1.9022	-0.9792	-0.0535	0.3583	-0.3579
18	-0.5249	-2.2824	-0.6478	-0.4252	0.3568	-0.1122	0.7694	-1.8962	-0.6764	-0.0332	0.0354	-0.3882
19	-0.3259	-2.3185	-0.3852	-0.5370	0.3507	-0.0112	0.7655	-1.9994	-0.4089	-0.0222	-0.0151	-0.4511
20	-1.0850	-2.4008	-0.1053	-0.6397	0.3308	0.0600	0.7564	-1.6461	-0.1142	-0.0162	-0.0525	-0.5212
21	-0.2939	-2.5219	0.1535	-0.7719	0.2509	0.0646	0.6791	-1.7208	0.1667	-0.0614	-0.1297	-0.6328
22	-0.0311	-2.4978	0.3644	-0.8444	0.1533	0.0331	0.5520	-1.6845	0.4444	-0.1067	0.2126	-0.7069
23	-0.9364	-2.2288	0.4831	-0.8602	0.0148	-0.0679	0.4117	-1.6941	0.7381	-0.1864	0.1505	-0.7438
24	-0.0674	-2.7518	0.4255	-0.7801	0.1826	0.1133	0.1034	-1.3474	0.8475	0.0709	0.1537	-0.0748

Figure 4-7. Vessel dome pressure (5 seconds)

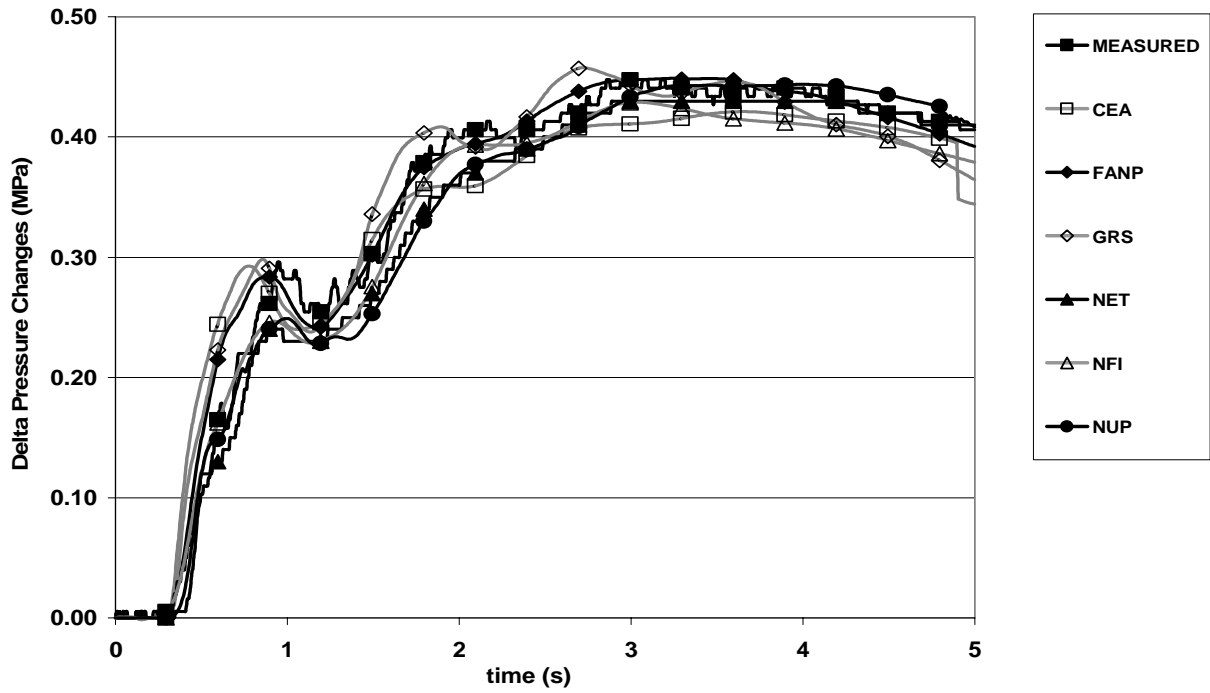

Figure 4-8. Vessel dome pressure (5 seconds)

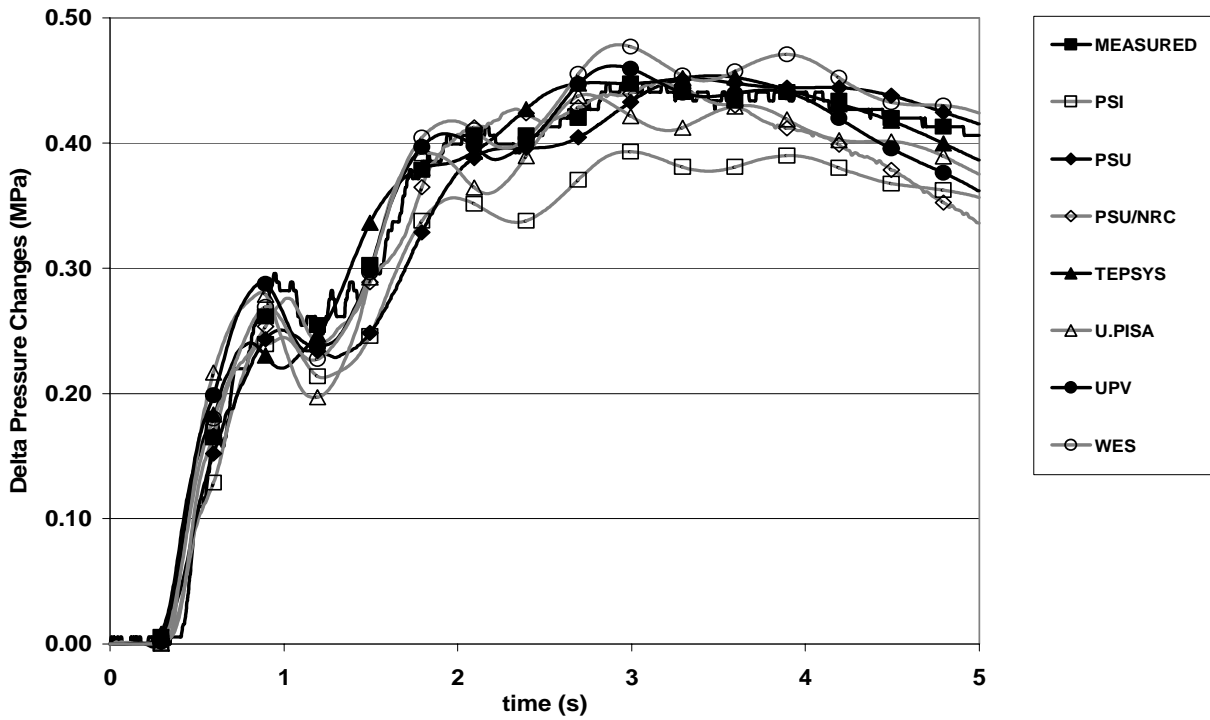

Figure 4-9. Vessel dome pressure – measured vs. averaged data (5 seconds)

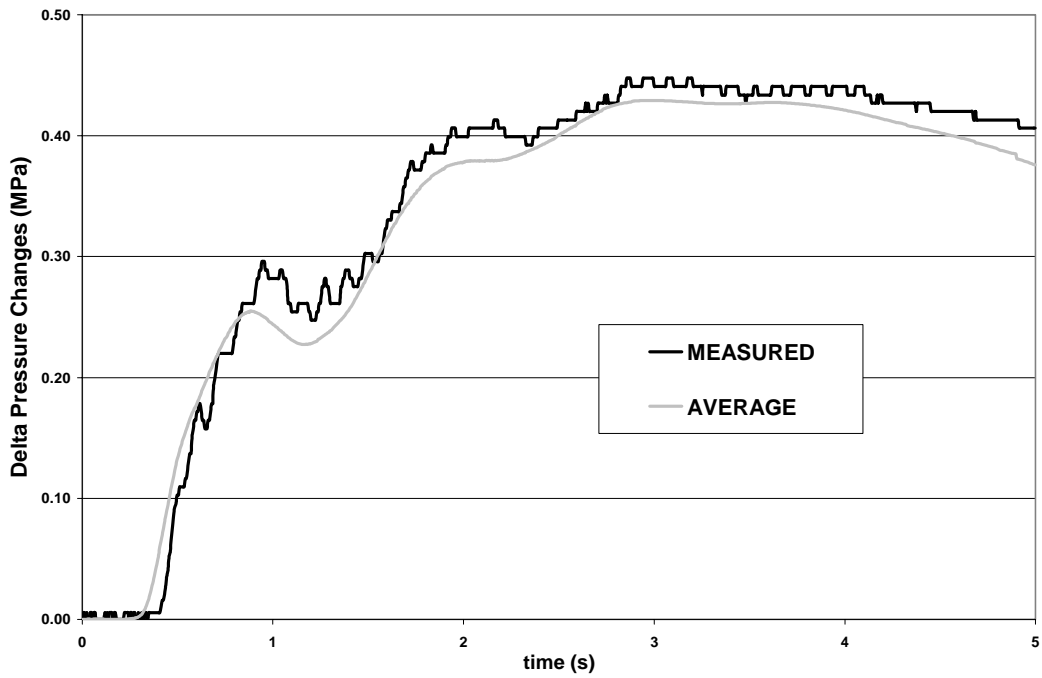

Table 4-6. Vessel dome pressure FOM – participant vs. measured data (5 seconds)

Participants	D'Auria FFT	Mean error
CEA	0.828037	0.982646
FANP	0.885103	0.988965
GRS	0.852758	0.987540
NETCORP	0.871570	0.968806
NFI	0.881309	0.966439
NUPEC	0.884493	0.978238
PSI	0.842589	0.912324
PSU	0.880791	0.983431
PSU /NRC	0.866089	0.975788
TEPSYS	0.869565	0.986657
UPISA	0.857825	0.976782
UPV	0.872835	0.996351
Westinghouse	0.877271	0.971293

Figure 4-10. Vessel dome pressure (1.5 seconds)

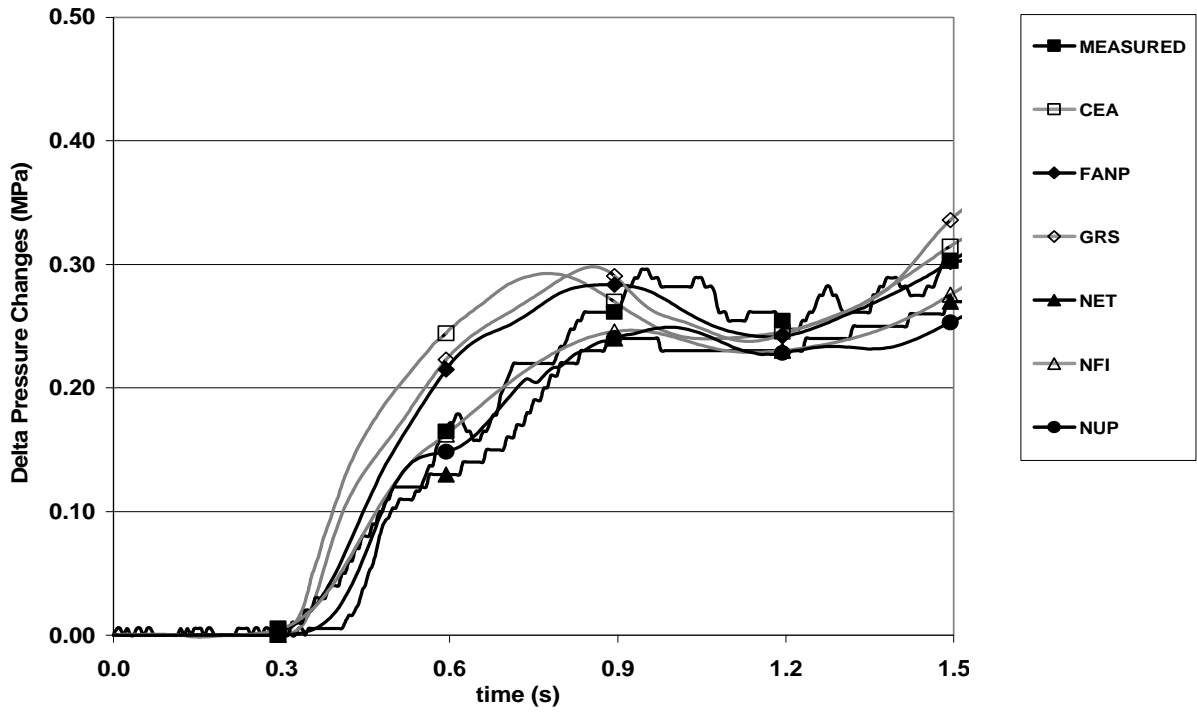

Figure 4-11. Vessel dome pressure (1.5 seconds)

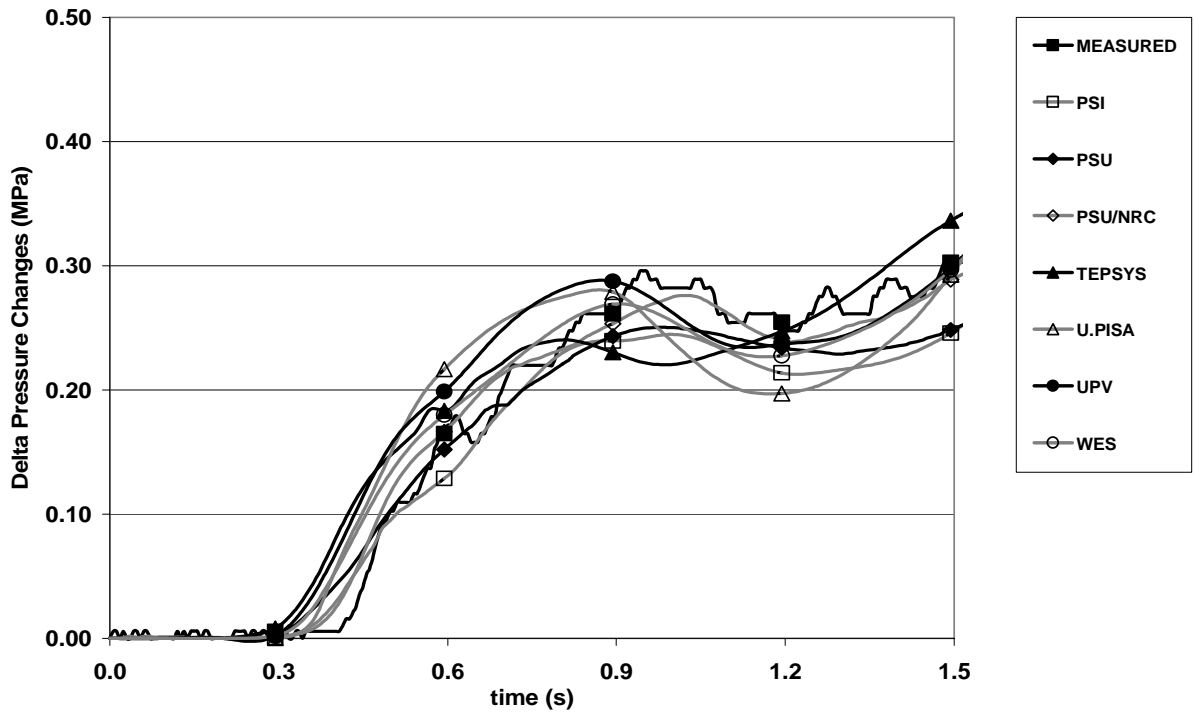

Figure 4-12. Vessel dome pressure – measured vs. averaged data (1.5 seconds)

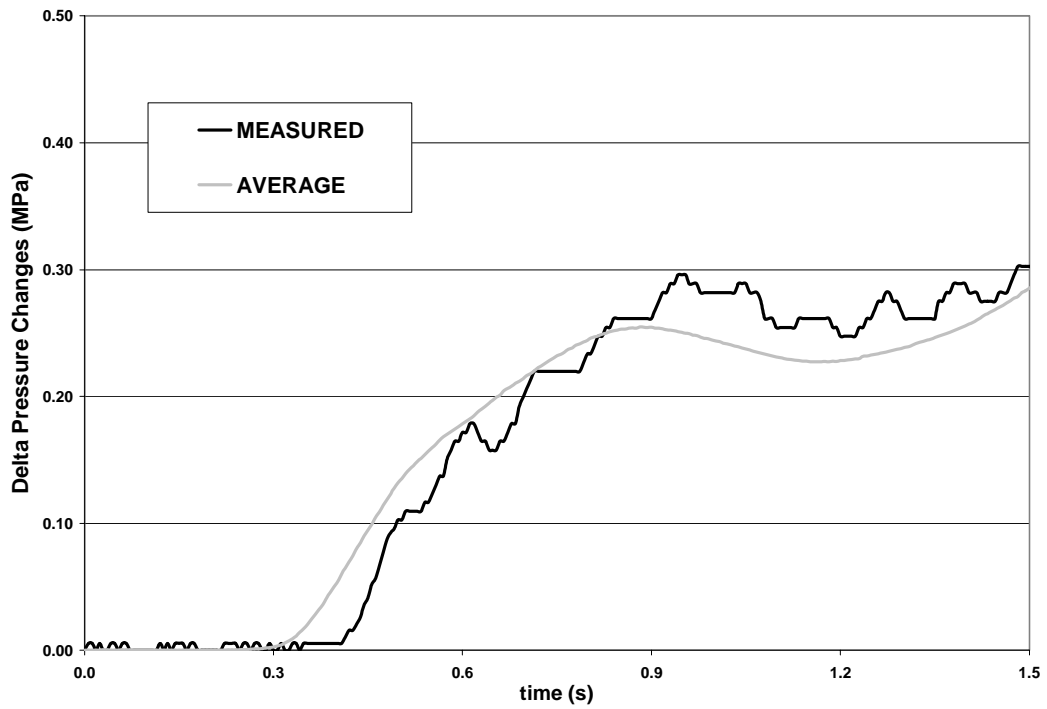

Table 4-7. Vessel dome pressure FOM – participant vs. measured data (1.5 seconds)

Participants	D'Auria FFT	Mean error
CEA	0.756886	0.928376
FANP	0.825679	0.958118
GRS	0.782096	0.940894
NETCORP	0.820257	0.947105
NFI	0.850961	0.972152
NUPEC	0.837275	0.951302
PSI	0.819942	0.934641
PSU	0.831920	0.957261
PSU/NRC	0.882162	0.993100
TEPSYS	0.809503	0.980646
UPISA	0.824089	0.997984
UPV	0.821020	0.966431
Westinghouse	0.860597	0.999617

Figure 4-13. Core exit pressure (5 seconds)

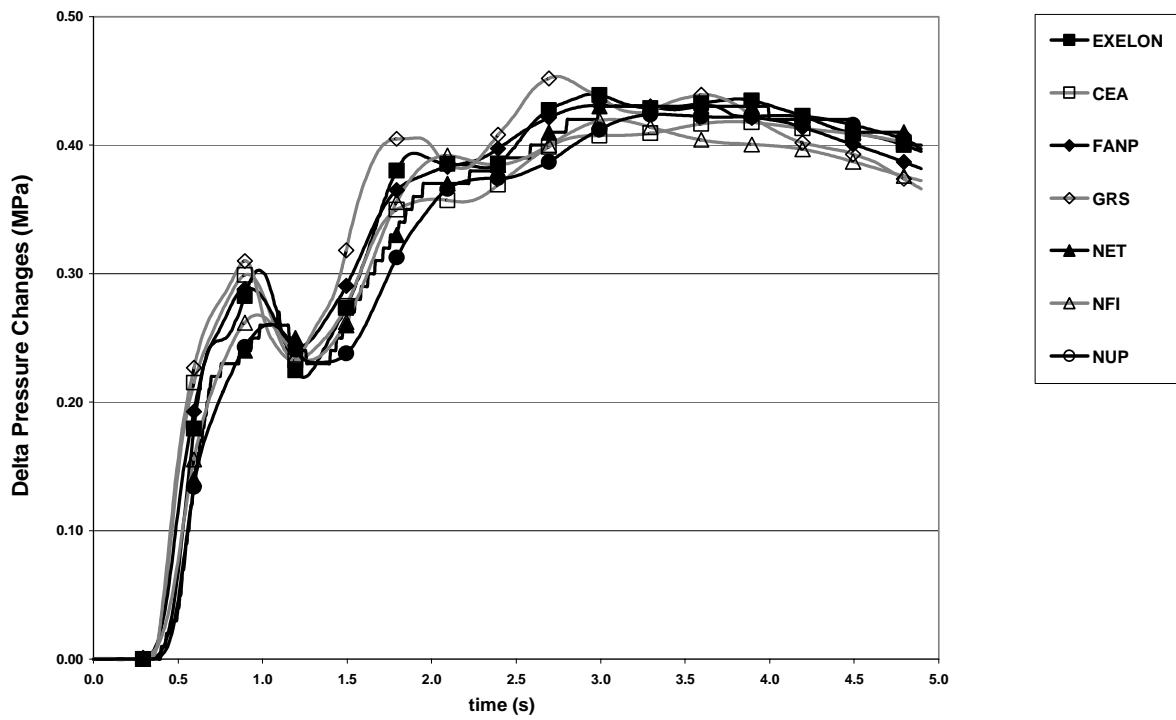

Figure 4-14. Core exit pressure (5 seconds)

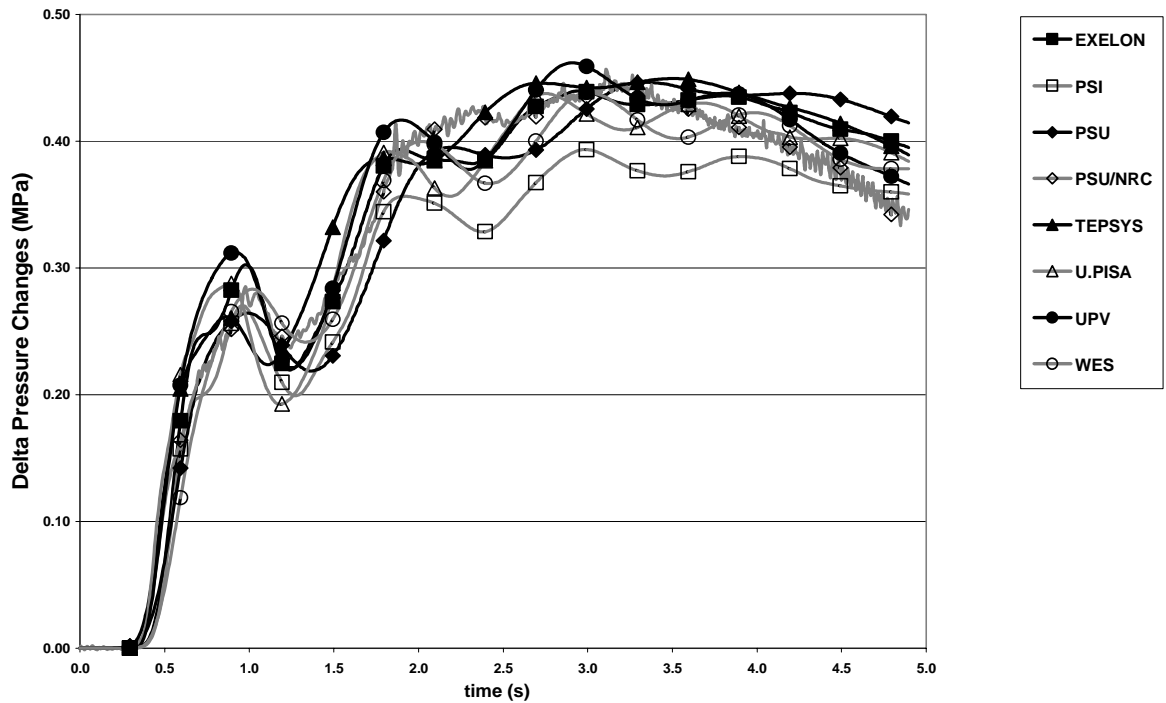

Figure 4-15. Core exit pressure – Exelon vs. averaged data (5 seconds)

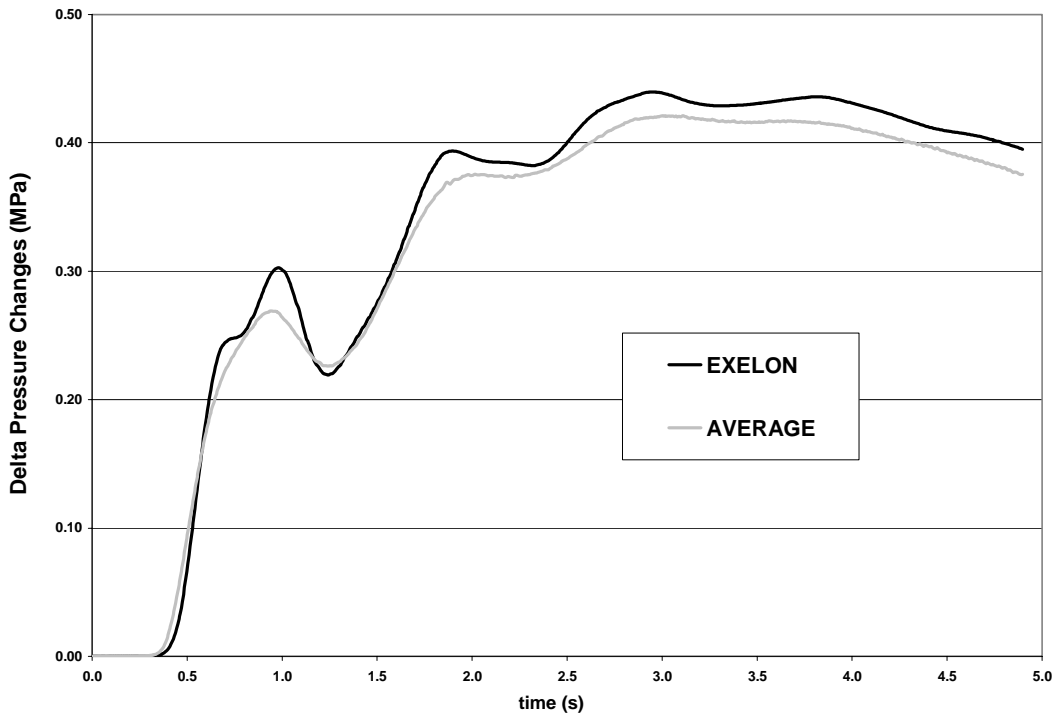

Table 4-8. Core exit pressure FOM – participant vs. Exelon data (5 seconds)

Participants	D'Auria FFT	Mean error
CEA	0.814507	0.982300
FANP	0.860783	0.998363
GRS	0.854806	0.984252
NETCORP	0.890288	0.977578
NFI	0.833606	0.96538
NUPEC	0.828507	0.961375
PSI	0.839428	0.919174
PSU	0.854025	0.988059
PSU/NRC	0.862058	0.985494
TEPSYS	0.824385	0.976990
UPISA	0.790233	0.989411
UPV	0.881102	0.987486
Westinghouse	0.810725	0.971534

Figure 4-16. Core exit pressure (1.5 seconds)

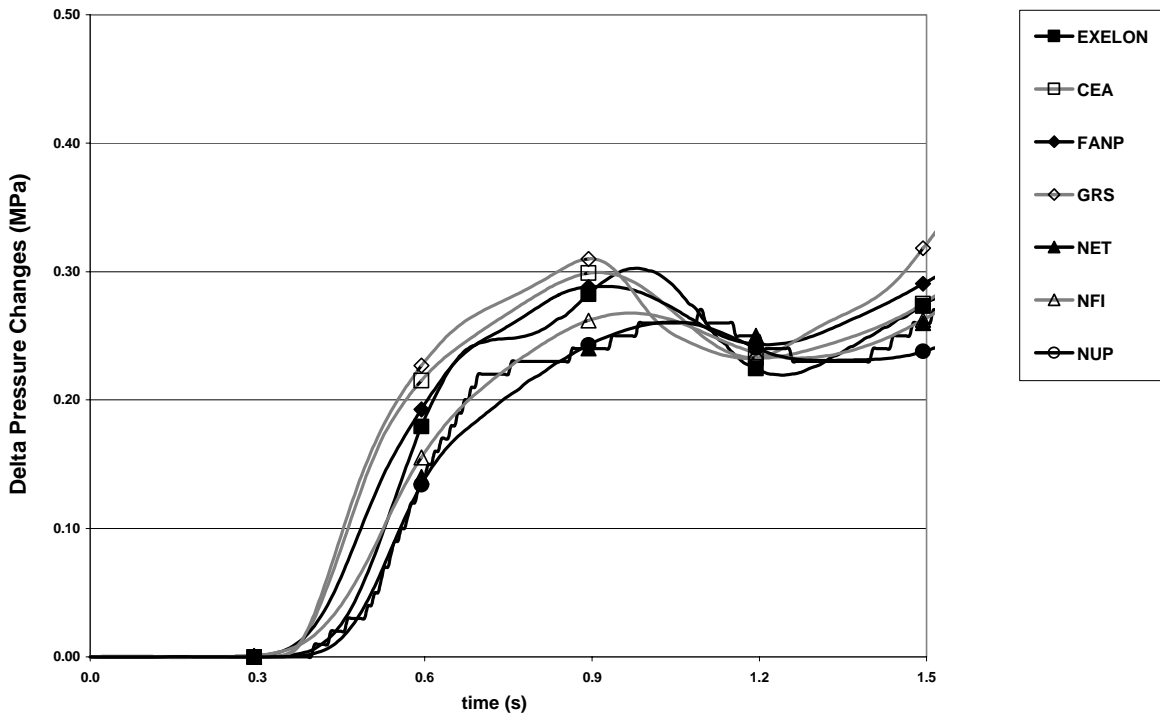

Figure 4-17. Core exit pressure (1.5 seconds)

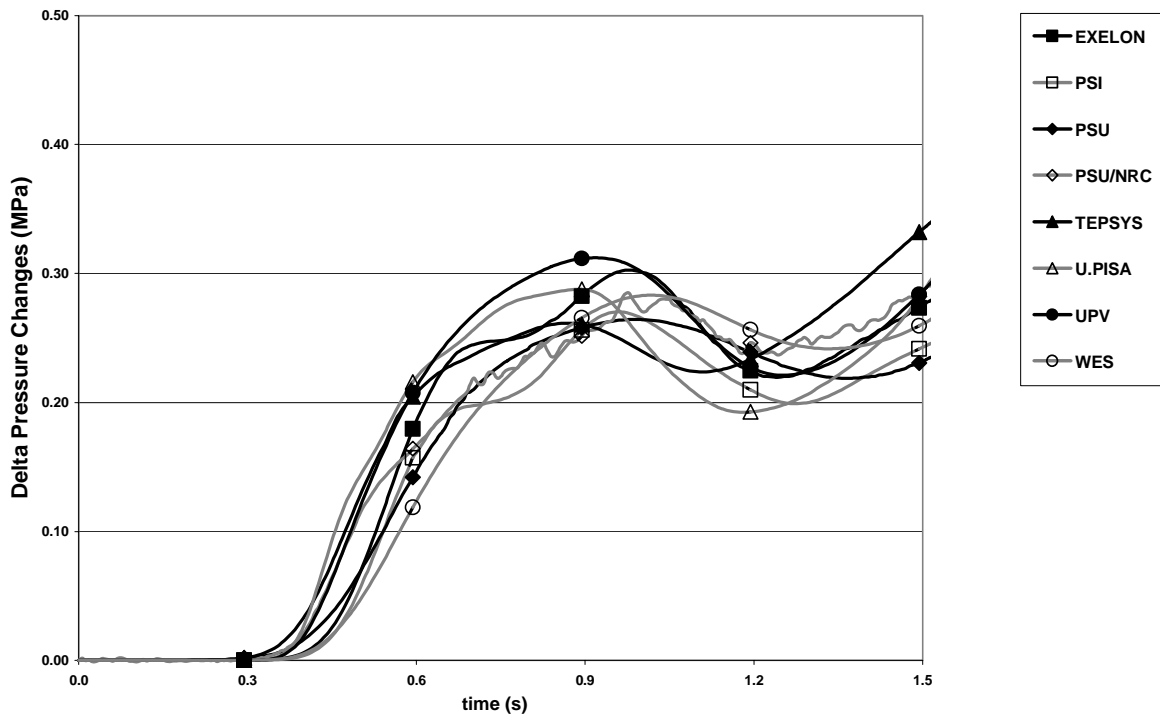

Figure 4-18. Core exit pressure – Exelon vs. averaged data (1.5 seconds)

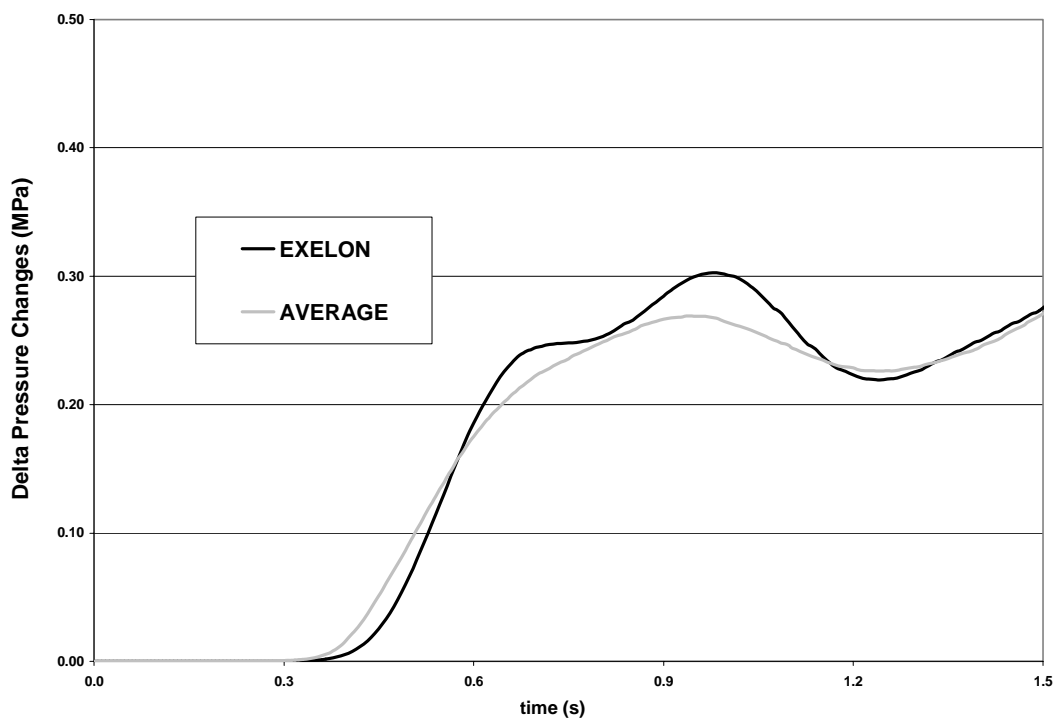

Table 4-9. Core exit pressure FOM – participant vs. Exelon data (1.5 seconds)

Participants	D'Auria FFT	Mean error
CEA	0.811733	0.961451
FANP	0.828060	0.968435
GRS	0.802623	0.942384
NETCORP	0.847156	0.956179
NFI	0.815541	0.976066
NUPEC	0.820173	0.944192
PSI	0.835825	0.938156
PSU	0.851292	0.961372
PSU/NRC	0.859699	0.999202
TEPSYS	0.818468	0.977226
UPISA	0.798261	0.998377
UPV	0.819631	0.960493
Westinghouse	0.791952	0.969443

Figure 4-19. Jet pump flow rate (5 seconds)

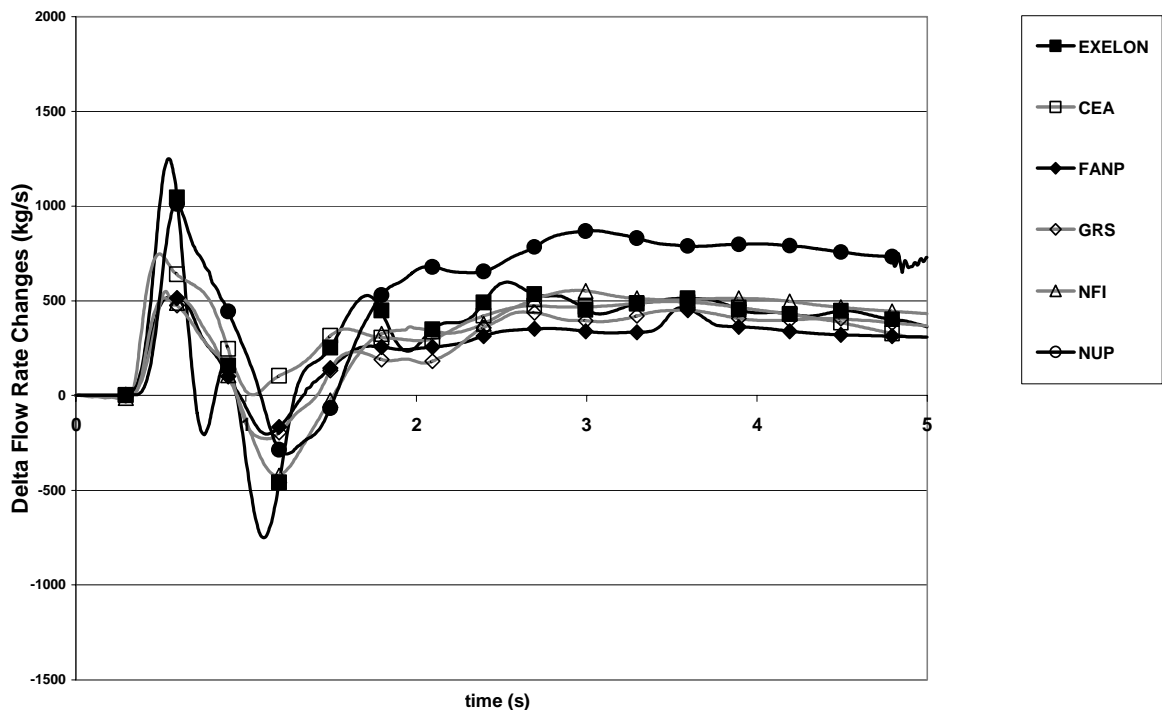

Figure 4-20. Jet pump flow rate (5 seconds)

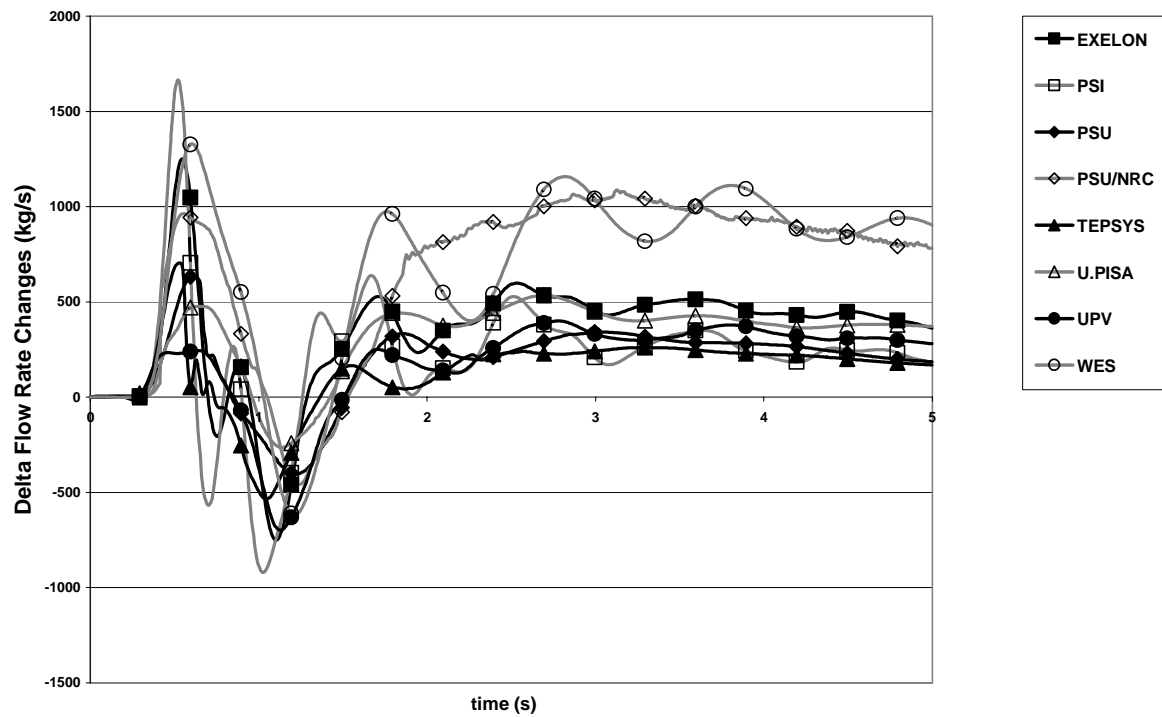

Figure 4-21. Jet pump flow rate – Exelon vs. averaged data (5 seconds)

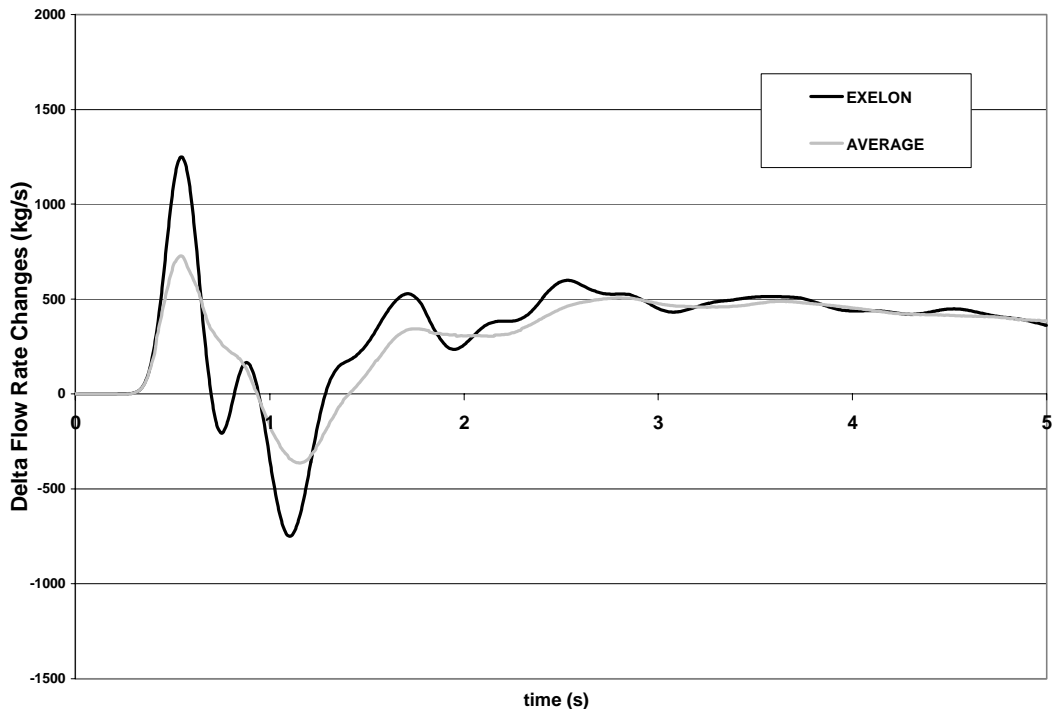

Table 4-10. Jet pump flow rate FOM – participant vs. Exelon data (5 seconds)

Participants	D'Auria FFT	Mean error
CEA	0.632452	0.986841
FANP	0.631828	0.962128
GRS	0.643767	0.971611
NFI	0.656687	0.991434
NUPEC	0.559590	0.900471
PSI	0.618890	0.939688
PSU	0.623257	0.928375
PSU/NRC	0.495413	0.863238
TEPSYS	0.598229	0.908011
UPISA	0.634360	0.987226
UPV	0.621570	0.926363
Westinghouse	0.514555	0.853835

Figure 4-22. Jet pump flow rate (1.5 seconds)

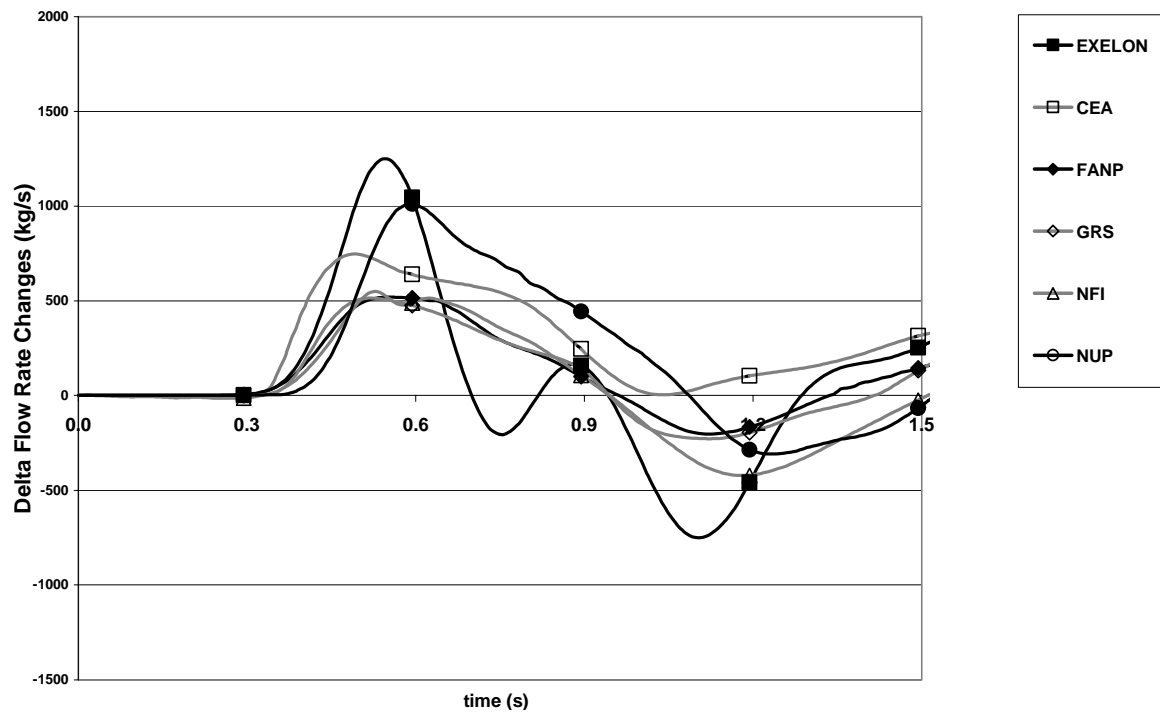

Figure 4-23. Jet pump flow rate (1.5 seconds)

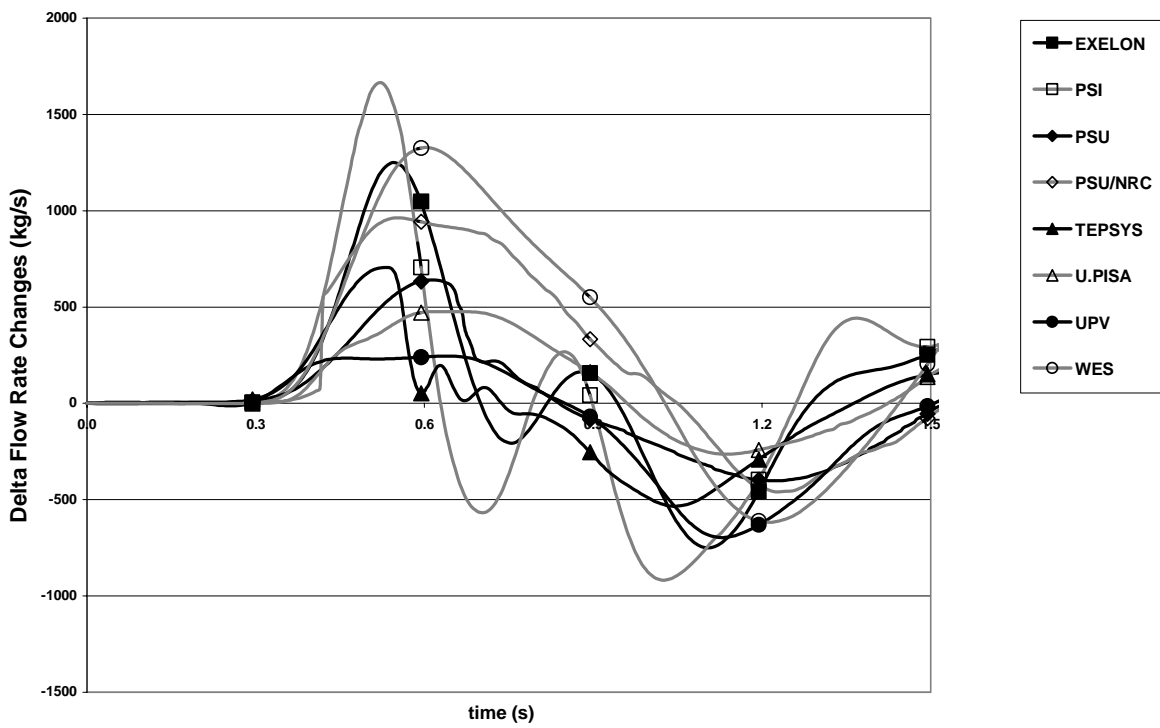

Figure 4-24. Jet pump flow rate – Exelon vs. averaged data (5 seconds)

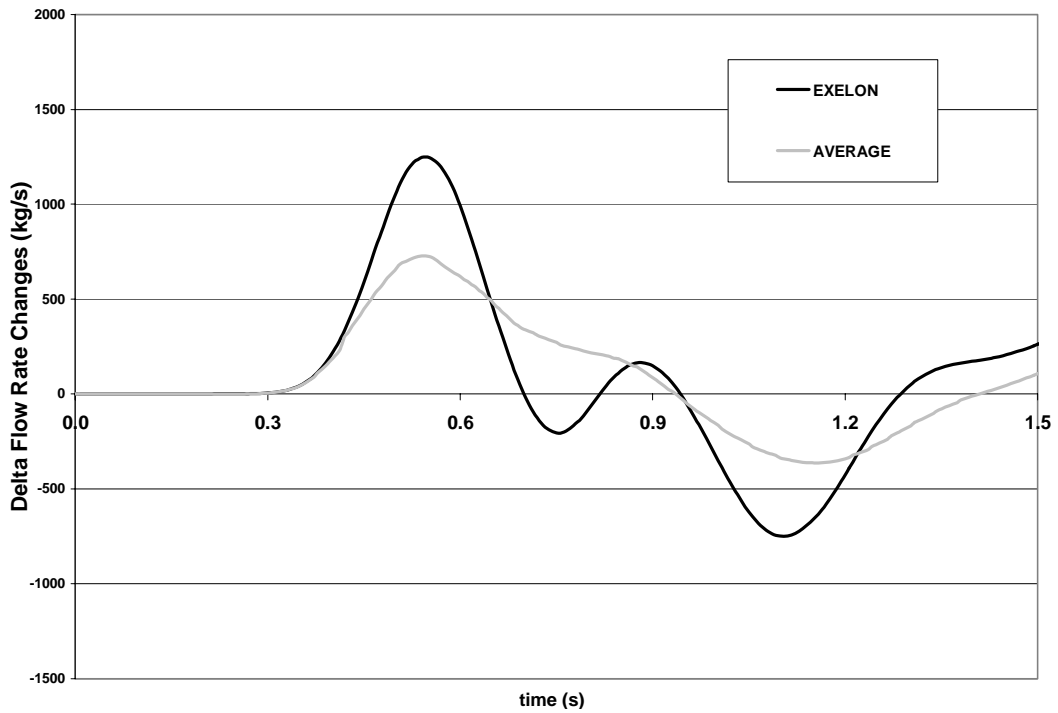

Table 4-11. Jet pump flow rate FOM – participant vs. Exelon data (1.5 seconds)

Participants	D'Auria FFT	Mean error
CEA	0.632452	0.986841
FANP	0.631828	0.962128
GRS	0.643767	0.971611
NFI	0.656687	0.991434
NUPEC	0.559590	0.900471
PSI	0.618890	0.939688
PSU	0.623257	0.928375
PSU/NRC	0.495413	0.863238
TEPSYS	0.598229	0.908011
UPISA	0.634360	0.987226
UPV	0.621570	0.926363
Westinghouse	0.514555	0.853835

Figure 4-25. Core in-channel flow rate (5 seconds)

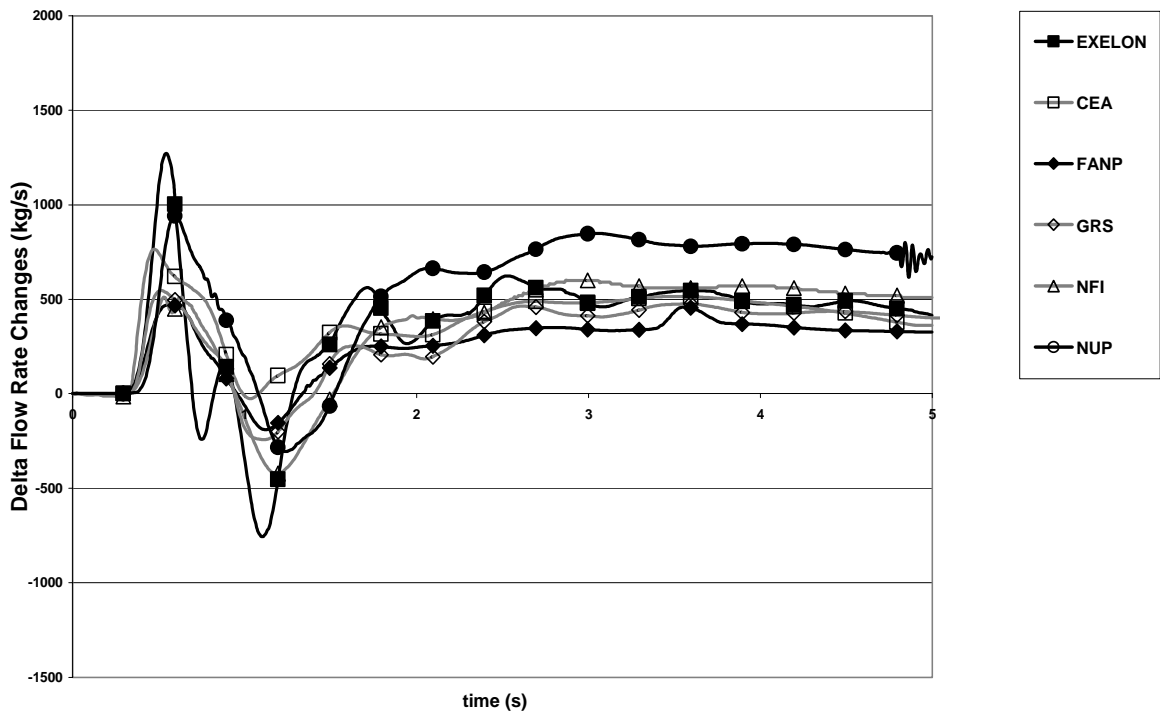

Figure 4-26. Core in-channel flow rate (5 seconds)

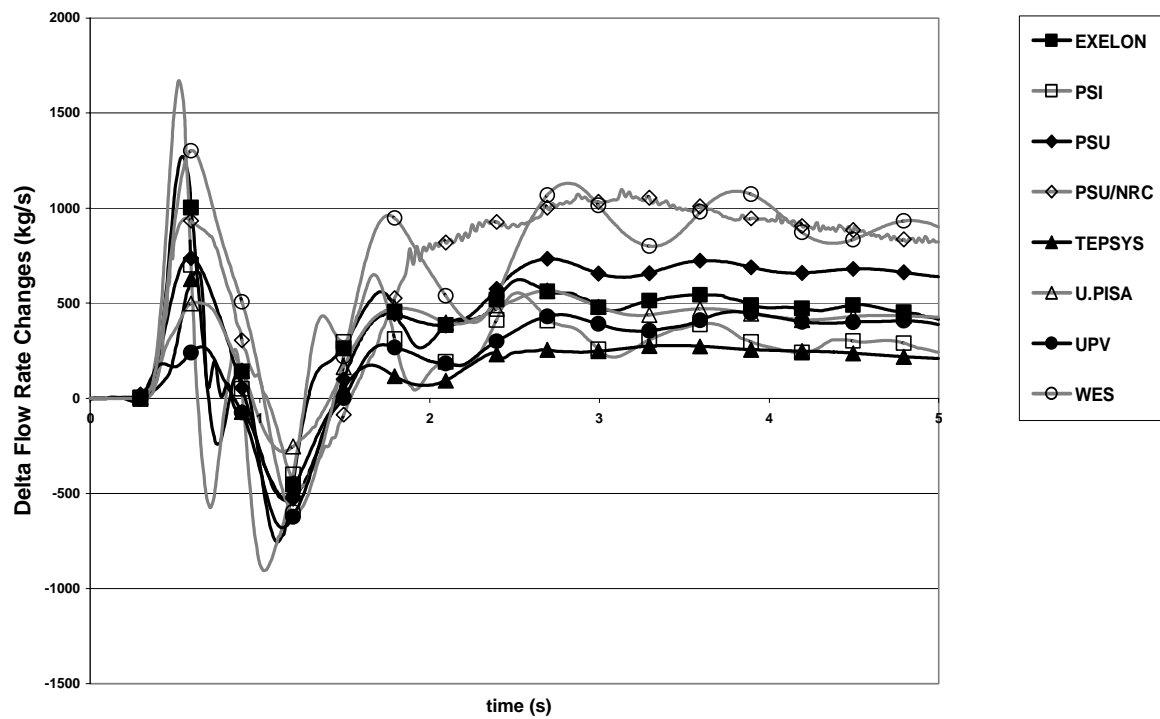

Figure 4-27. Core in-channel flow rate – Exelon vs. averaged data (5 seconds)

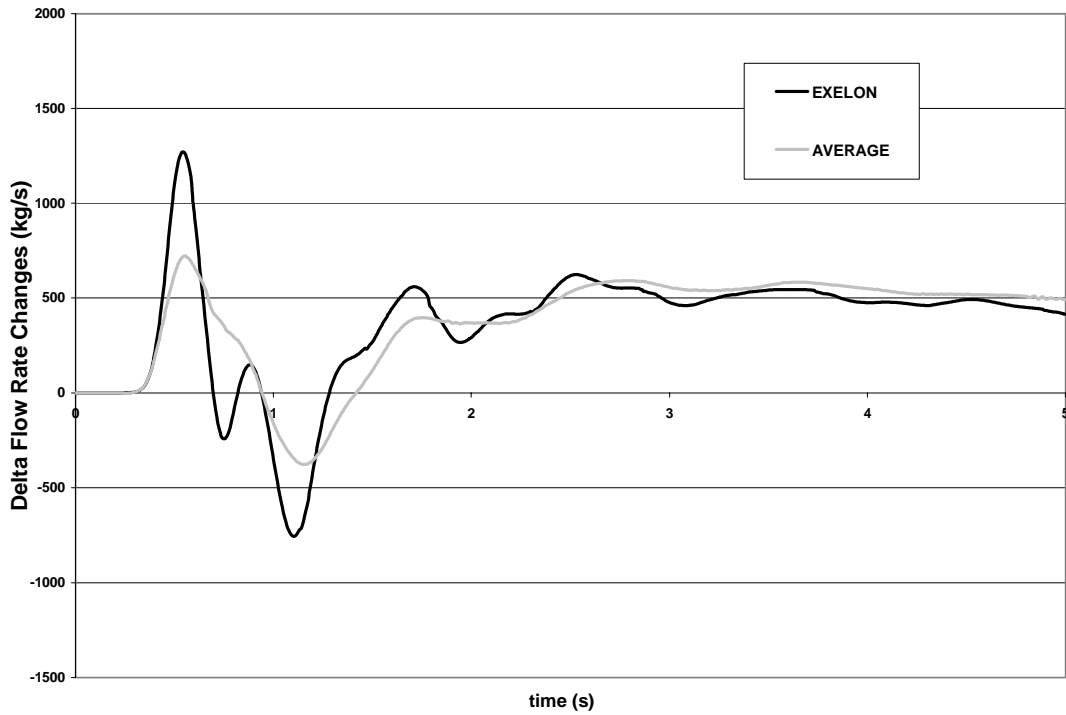

Table 4-12. Core in-channel flow rate FOM – participant vs. Exelon data (5 seconds)

Participants	D'Auria FFT	Mean error
CEA	0.638910	0.991234
FANP	0.649355	0.969817
GRS	0.649255	0.969817
NFI	0.656670	0.997138
NUPEC	0.572426	0.915737
PSI	0.643341	0.942567
PSU	0.645504	0.961227
PSU/NRC	0.522176	0.872593
TEPSYS	0.590639	0.904306
UPISA	0.652023	0.989703
UPV	0.623379	0.936095
Westinghouse	0.537434	0.867945

Figure 4-28. Core in-channel flow rate (1.5 seconds)

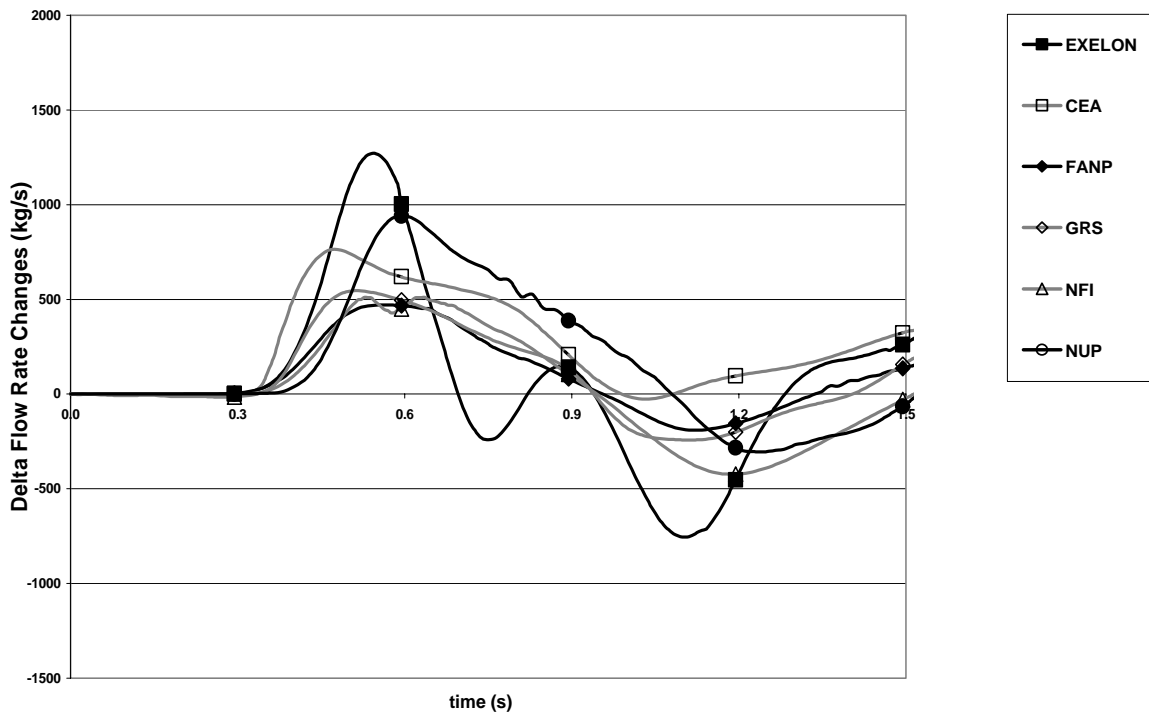

Figure 4-29. Core in-channel flow rate (1.5 seconds)

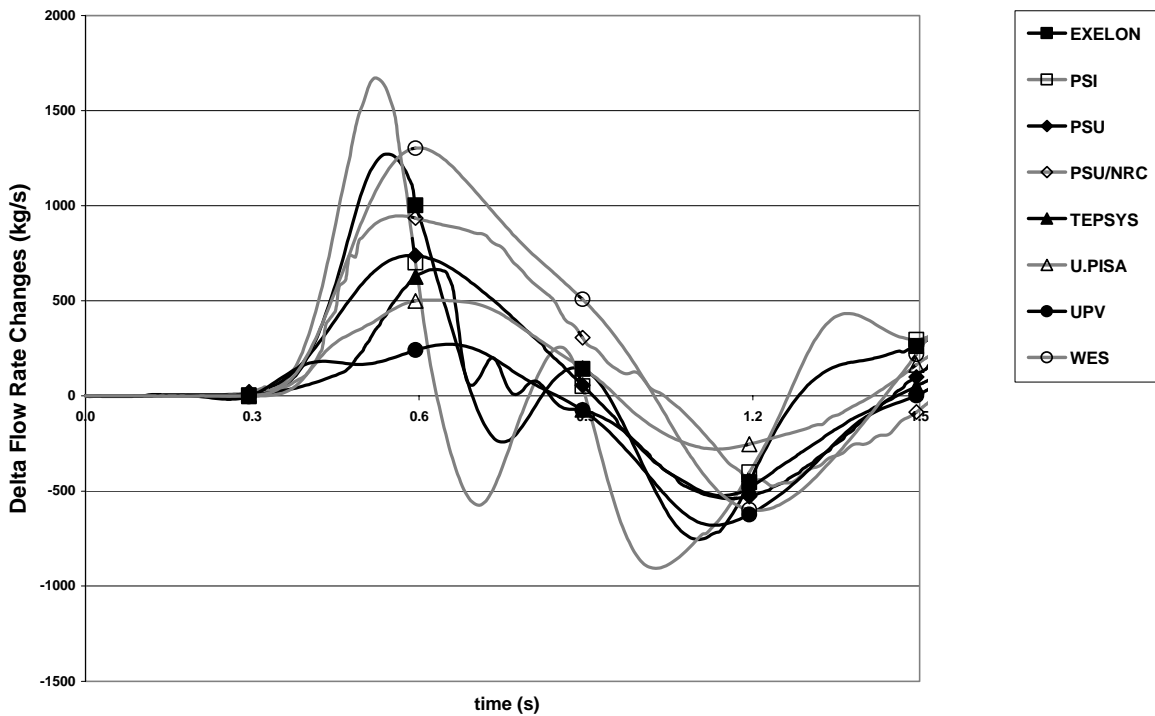

Figure 4-30. Core in-channel flow rate – Exelon vs. averaged data (1.5 seconds)

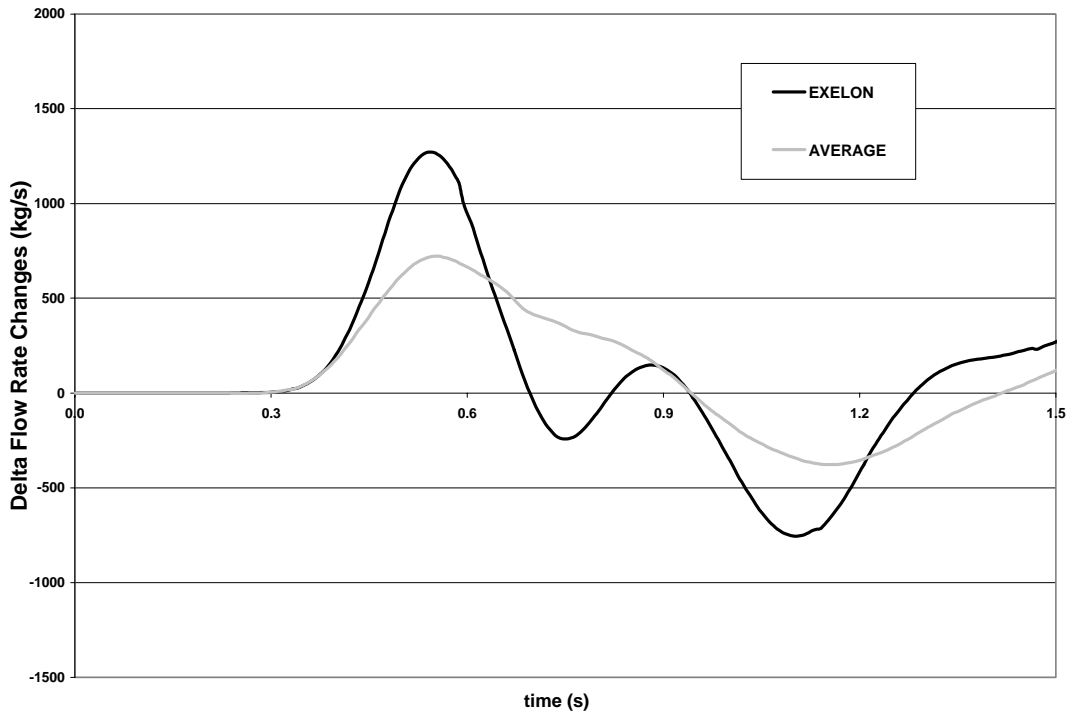

Table 4-13. Core in-channel flow rate FOM – participant vs. Exelon data (1.5 seconds)

Participants	D'Auria FFT	Mean error
CEA	0.638910	0.991234
FANP	0.649355	0.969817
GRS	0.649255	0.969817
NFI	0.656670	0.997138
NUPEC	0.572426	0.915737
PSI	0.643341	0.942567
PSU	0.645504	0.961227
PSU/NRC	0.522176	0.872593
TEPSYS	0.590639	0.904306
UPISA	0.652023	0.989703
UPV	0.623379	0.936095
Westinghouse	0.537434	0.867945

Figure 4-31. Steam bypass flow rate (5 seconds)

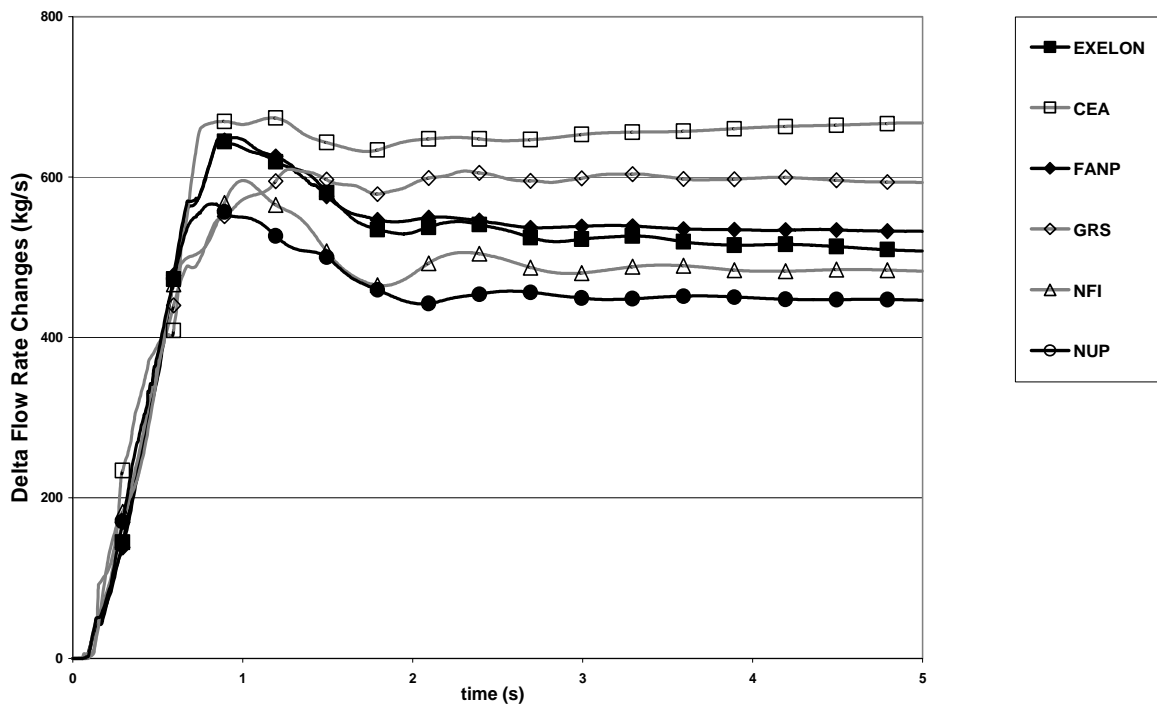

Figure 4-32. Steam bypass flow rate (5 seconds)

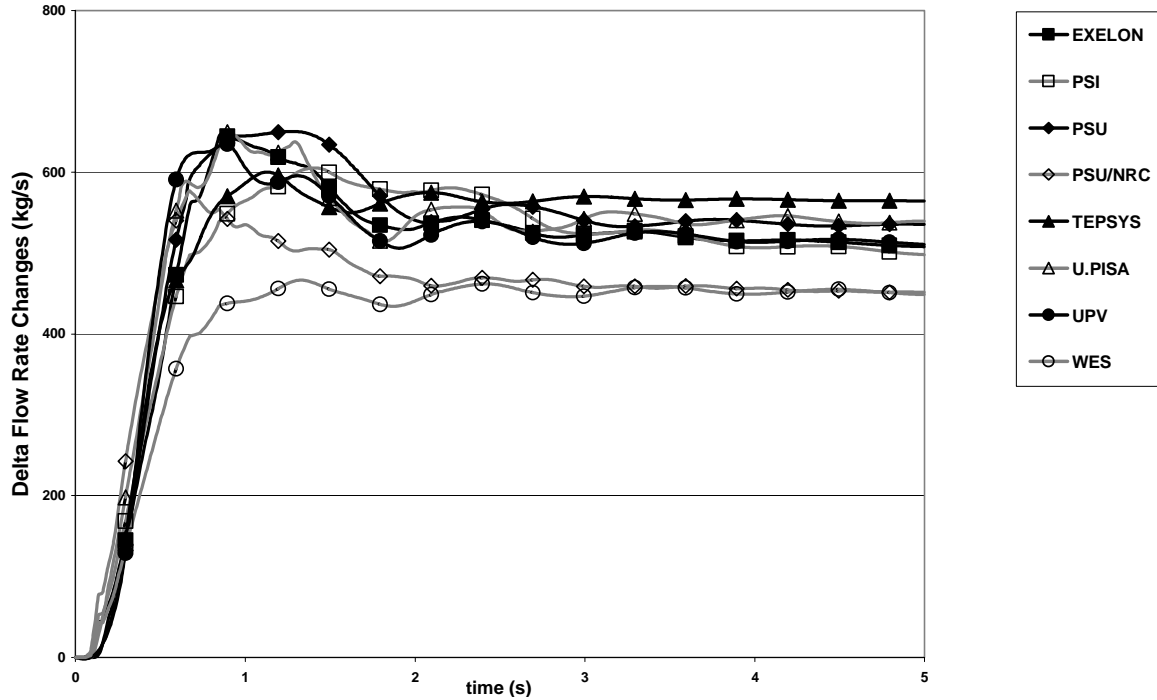

Figure 4-33. Steam bypass flow rate – Exelon vs. averaged data (5 seconds)

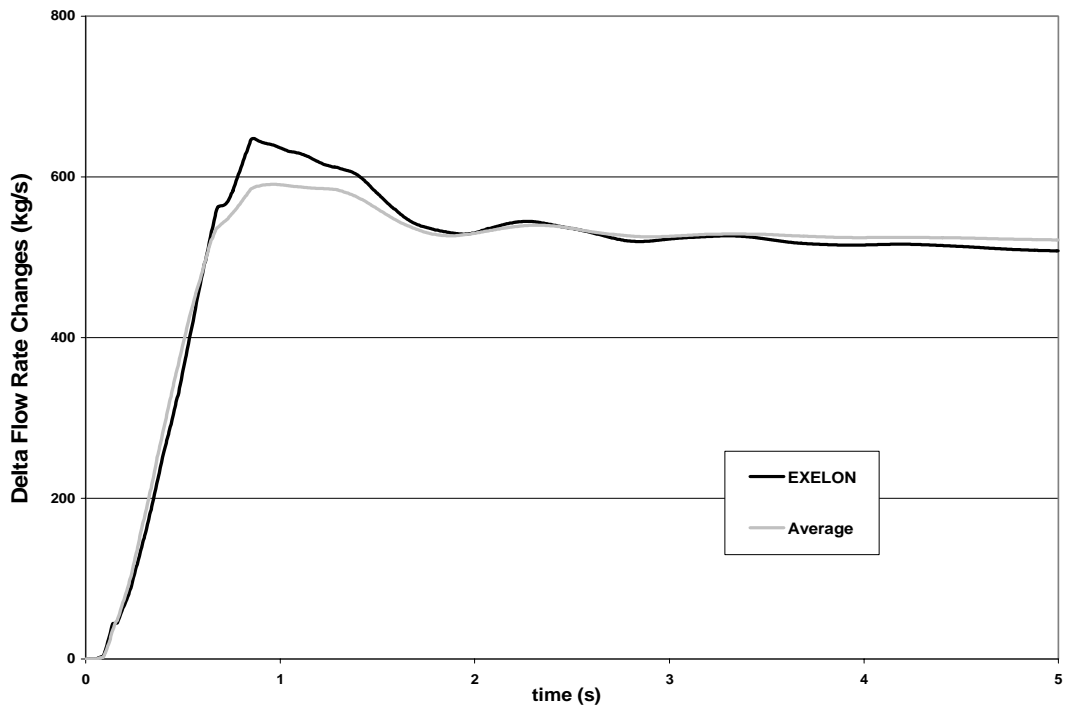

Table 4-14. Steam bypass flow rate FOM – participant vs. Exelon data (5 seconds)

Participants	D'Auria FFT	Mean error
CEA	0.779968	0.865189
FANP	0.885318	0.984254
GRS	0.815970	0.937836
NFI	0.824380	0.945642
NUPEC	0.822632	0.911949
PSI	0.759959	0.999926
PSU	0.836952	0.968644
PSU/NRC	0.789913	0.928899
TEPSYS	0.827886	0.967461
UPISA	0.819684	0.973376
UPV	0.721839	0.998870
Westinghouse	0.793363	0.883658

Figure 4-34. Steam bypass flow rate (1.5 seconds)

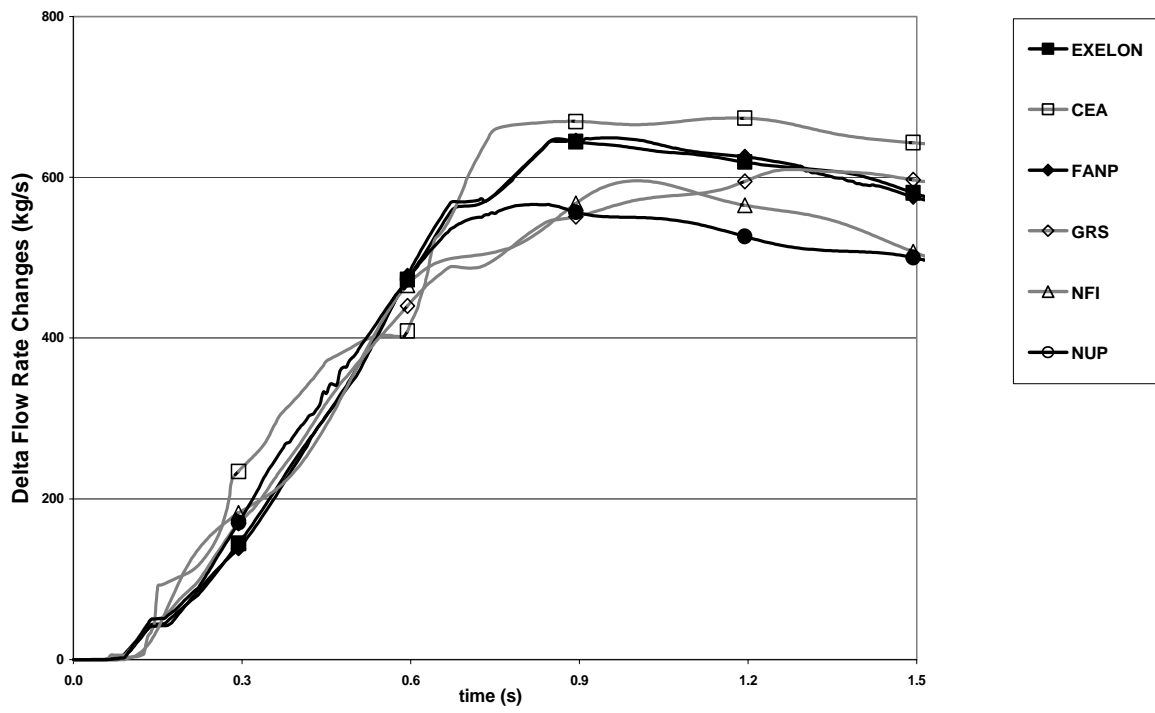

Figure 4-35. Steam bypass flow rate (1.5 seconds)

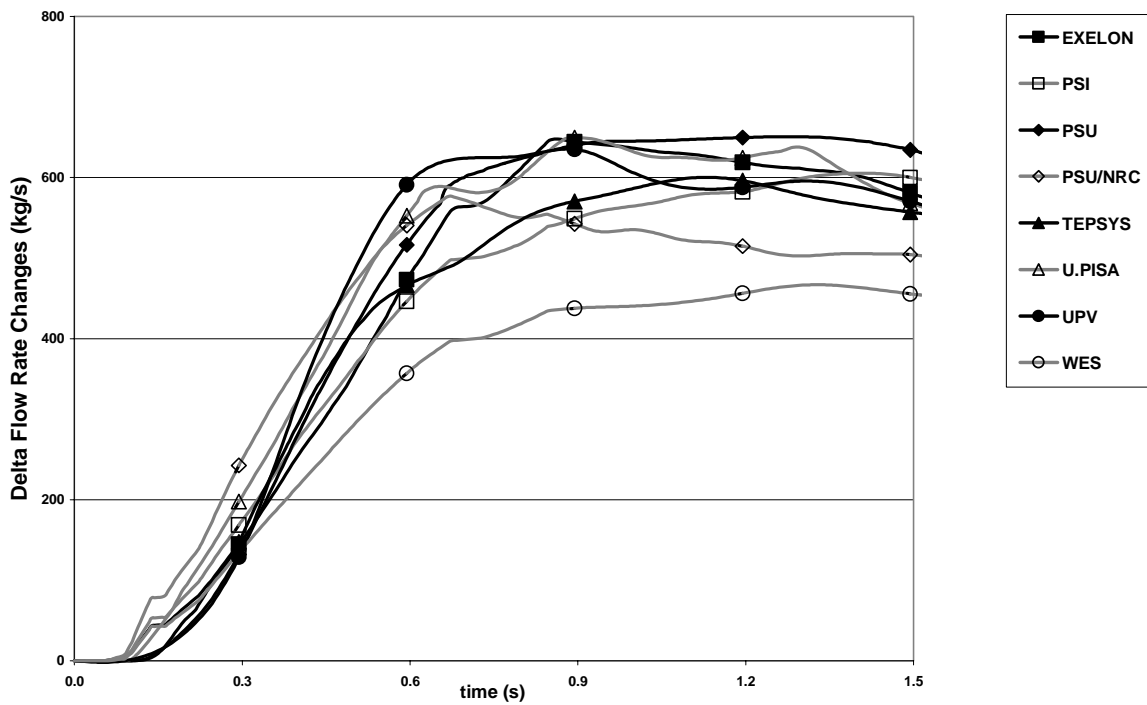

Figure 4-36. Steam bypass flow rate – Exelon vs. averaged data (1.5 seconds)

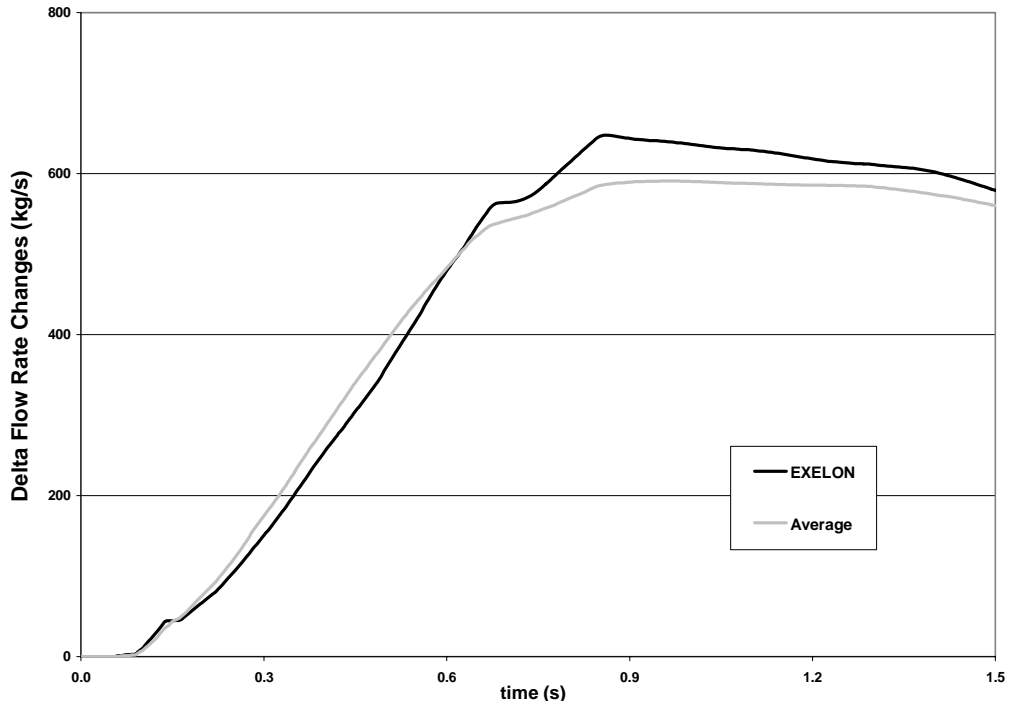

Table 4-15. Steam bypass flow rate FOM – participant vs. Exelon data (1.5 seconds)

Participants	D'Auria FFT	Mean error
CEA	0.849663	0.947216
FANP	0.919241	0.999309
GRS	0.864690	0.964516
NFI	0.840617	0.951867
NUPEC	0.845051	0.944996
PSI	0.865657	0.963570
PSU	0.880917	0.971740
PSU/NRC	0.837732	0.973358
TEPSYS	0.822172	0.967200
UPISA	0.857962	0.966541
UPV	0.817225	0.982058
Westinghouse	0.770214	0.852074

Figure 4-37. Turbine inlet pressure (5 seconds)

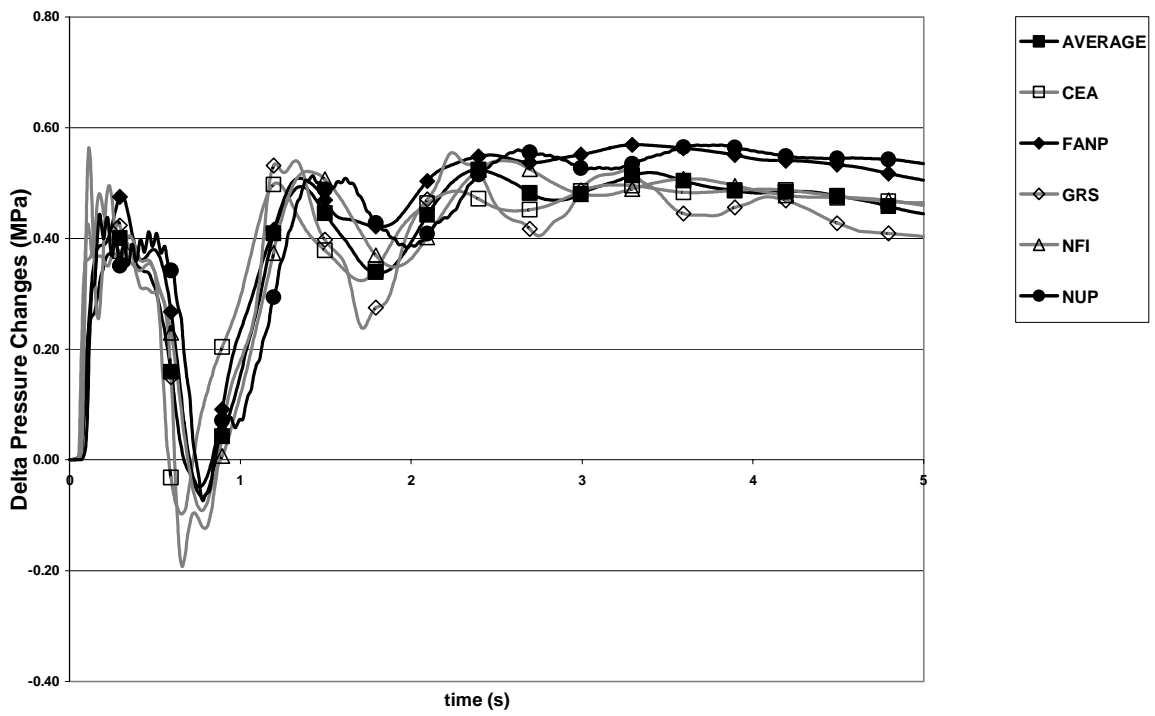

Figure 4-38. Turbine inlet pressure (5 seconds)

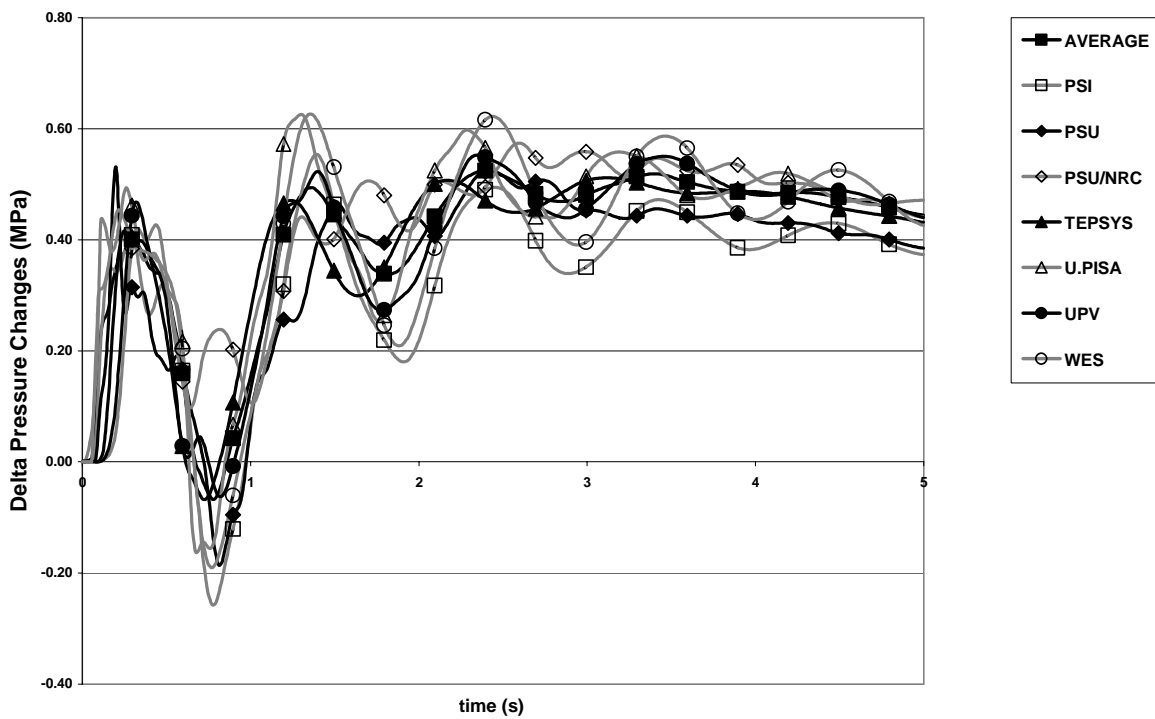

Table 4-16. Turbine inlet pressure FOM – participant vs. averaged data (5 seconds)

Participants	D'Auria FFT	Mean error
CEA	0.768247	0.994379
FANP	0.815086	0.922731
GRS	0.781540	0.967382
NFI	0.790493	0.989711
NUPEC	0.765019	0.941782
PSI	0.768060	0.892899
PSU	0.731602	0.96121
PSU/NRC	0.727749	0.968607
TEPSYS	0.752652	0.981105
UPISA	0.791697	0.971980
UPV	0.752164	0.981043
Westinghouse	0.815964	0.999511

Table 4-17. Turbine inlet pressure FOM – participant vs. averaged data (1.5 seconds)

Participants	D'Auria FFT	Mean error
CEA	0.774653	0.999697
FANP	0.817505	0.927251
GRS	0.780127	0.961526
NFI	0.790156	0.995539
NUPEC	0.764252	0.946661
PSI	0.761436	0.887322
PSU	0.710820	0.966465
PSU/NRC	0.733067	0.974009
TEPSYS	0.756667	0.975201
UPISA	0.793776	0.977449
UPV	0.755355	0.975139
Westinghouse	0.809388	0.994519

Figure 4-39. Turbine inlet pressure (1.5 seconds)

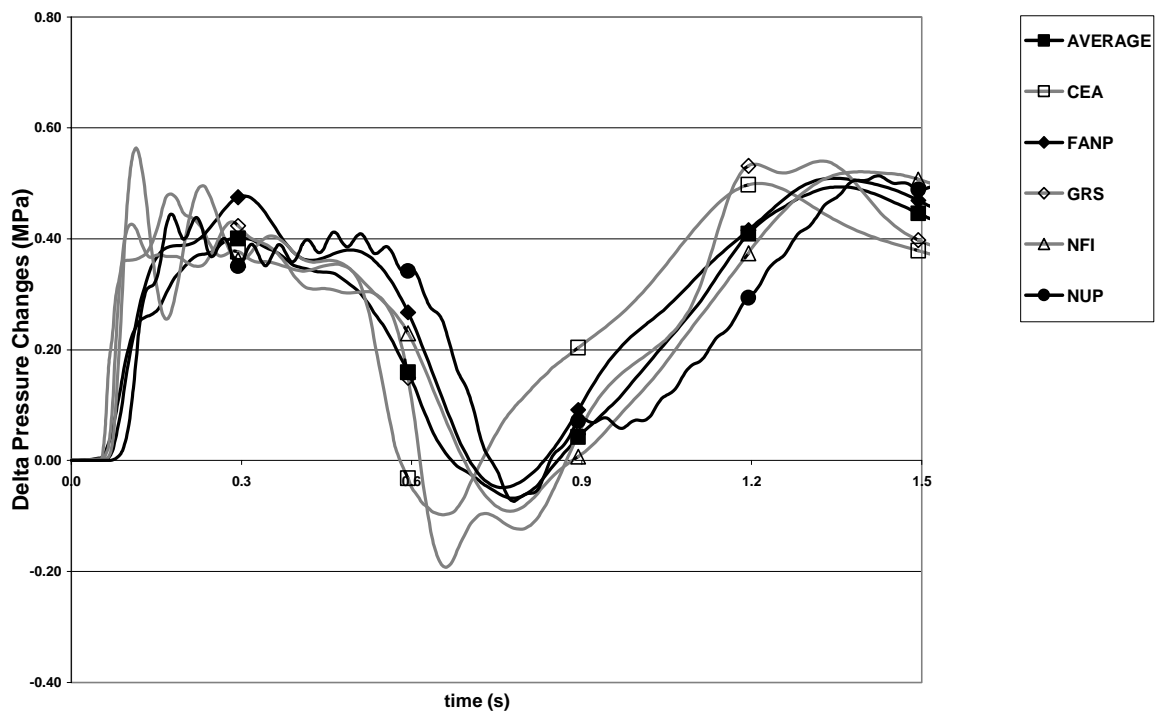

Figure 4-40. Turbine inlet pressure (1.5 seconds)

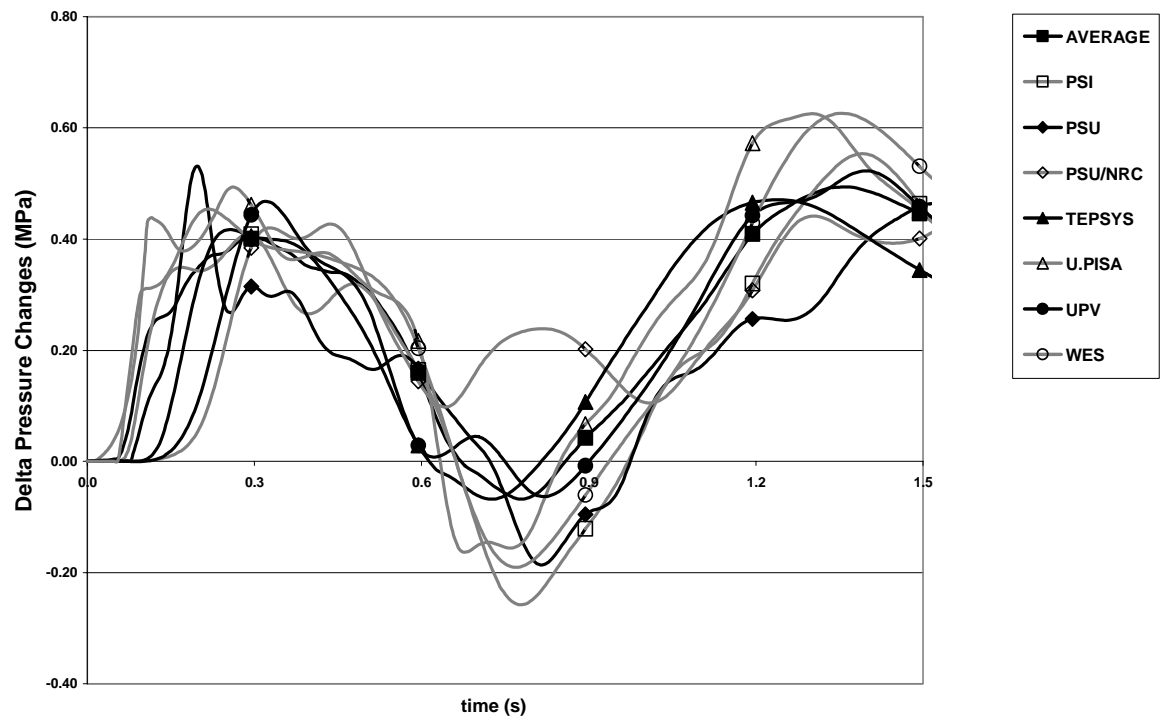

Table 4-18. Sequence of events

Participants	Event (milliseconds)				
	TSVC	BVBO	BVFO	DPIR	CEPIR
CEA	96	60	846	423	360
Exelon	96	60	846	432	486
FANP	96	60	846	400	390
GRS	96	60	846	420	354
NETCORP	90	60	850	516	342
NFI	96	60	846	403	406
NUPEC	96	60	846	510	396
PSI	96	60	852	444	450
PSU	90	60	846	420	408
PSU/NRC	90	60	846	438	396
TEPSYS	96	60	852	372	372
UPISA	96	60	846	398	390
UPV	96	60	846	398	390
Westinghouse	96	60	846	342	438
Measured Data	96	60	846	432	486

Description of events: TSVC – turbine stop valve closed, BVBO – bypass valve begins to open, BVFO – bypass valve fully open, DPIR – vessel dome pressure initial response (0.78% increase over initial value; % criterion based on reference result), CEPIR – core exit pressure initial response (0.27% increase over initial value; % criterion based on reference result).

Table 4-19. Time of the maximum peak

Participants	Time (seconds)					
	Dome pressure	Core exit pressure	Jet pump flow	Core inlet flow	Bypass flow	Turbine inlet pressure
CEA	3.738	3.762	0.492	0.474	1.176	1.212
Exelon	3.186*	2.940	0.546	0.546	0.864	N/A
FANP	3.000	3.000	0.552	0.564	0.954	3.318
GRS	2.718	2.742	0.522	0.516	1.278	2.238
NETCORP	2.890	2.990	0.510	N/A	N/A	N/A
NFI	3.027	3.049	2.916	2.868	1.002	0.114
NUPEC	3.999	3.339	0.594	0.594	0.846	3.816
PSI	2.976	2.988	0.522	0.522	1.410	1.392
PSU	3.366	3.348	0.612	0.588	1.272	0.198
PSU/NRC	3.144	3.264	3.126	3.132	0.672	2.598
TEPSYS	3.442	3.478	0.534	0.630	1.128	3.108
UPISA	2.736	2.754	2.700	2.700	0.894	1.302
UPV	2.900	2.900	2.778	3.798	0.882	2.346

* Since measured data is available, the measured dome pressure value was used as reference in lieu of the Exelon data.

Table 4-20. Maximum peak value (delta changes*)

Participants	Dome pressure (MPa)	Core exit pressure (MPa)	Jet pump flow (Kg/s)	Core in-channel flow (Kg/s)	Steam bypass flow (Kg/s)	Turbine inlet pressure (MPa)	MVCEP (%)**
CEA	0.421	0.418	747.0	765.000	673.8	0.500	106.1
Exelon	0.448***	0.439	1250.3	1271.307	647.7	N/A	106.4
FANP	0.449	0.430	519.3	470.836	648.9	0.569	106.0
GRS	0.458	0.453	514.0	546.700	609.6	0.555	106.6
NETCORP	0.430	0.430	700.0	N/A	N/A	N/A	106.3
NFI	0.429	0.420	554.2	601.090	595.6	0.564	106.1
NUPEC	0.444	0.424	1010.3	941.333	566.3	0.568	106.2
PSI	0.393	0.383	1666.1	1670.655	605.2	0.553	105.8
PSU	0.451	0.418	640.0	739.000	650.5	0.531	106.5
PSU/NRC	0.449	0.440	1086.4	1097.719	577.3	0.574	106.8
TEPSYS	0.454	0.430	705.0	664.137	600.1	0.512	106.6
UPISA	0.439	0.453	534.3	567.080	649.4	0.626	106.5
UPV	0.462	0.340	400.6	455.020	635.2	0.552	106.8
Westinghouse	0.479	0.430	1328.6	1302.810	466.7	0.626	106.3

* To avoid the effect of varying initialisation of participant data, all data are set to delta changes. The equation for this is $\Delta \text{changes} = \text{data} - \text{initial value}$.

** MVCEP is the maximum value in per cent of the initial value of the core exit pressure.

*** Since measured data is available for dome pressure, measured dome pressure value was used instead of Exelon data.

The calculated results presented in this chapter describe the thermal-hydraulic system response of participant models. A brief description of Exelon's code, RETRAN, is provided below given that some of the Exelon code results were used as reference in the comparisons, especially for time histories. In order to understand the comparisons, participant code descriptions (see Appendix A) must be taken into consideration.

RETRAN, which stands for Reactor Transient System Analysis Computer Code, has undergone a comprehensive qualification program by the Electric Power Research Institute (EPRI) and its RETRAN Working Group. Analyses of PB2 turbine trip transients were an important part of the RETRAN qualification program.

Figure 4-41 shows the definition of core regions in the RETRAN skeleton input deck as well as the flow paths of the reactor vessel, the reactor recirculation system and steam lines. A single volume (Volume 7) is used to model the steam space above the steam separators. The downcomer region is divided into three volumes. The upper downcomer (Volume 8) models the region surrounding the steam separators and includes the normal steam-water interface. The middle downcomer (Volume 9) models the region surrounding the standpipes and represents the volume where feedwater and liquid flow from steam separator mixes. The lower downcomer models the region surrounding the core shroud and jet pumps. Flow to recirculation loops and jet pump suction originate from this volume.

A single volume (Volume 1) is used to model the fluid region below the core support plate (lower plenum). The upper plenum region is above the upper guide plate and standpipes, which are modelled as single volumes (Volumes 4, 5). Two-sided, passive heat conductors are used to model the material of the shroud head and standpipes. A single volume is used to model the internal volume of the 211 steam separators. Since liquid flows from the separators, which include a steam carry-under, and enters the sub-cooled middle downcomer, the effects of carry-under can be ascertained without introducing steam bubbles into the liquid downcomer.

Figure 4-41. RETRAN PB2 thermal-hydraulic model

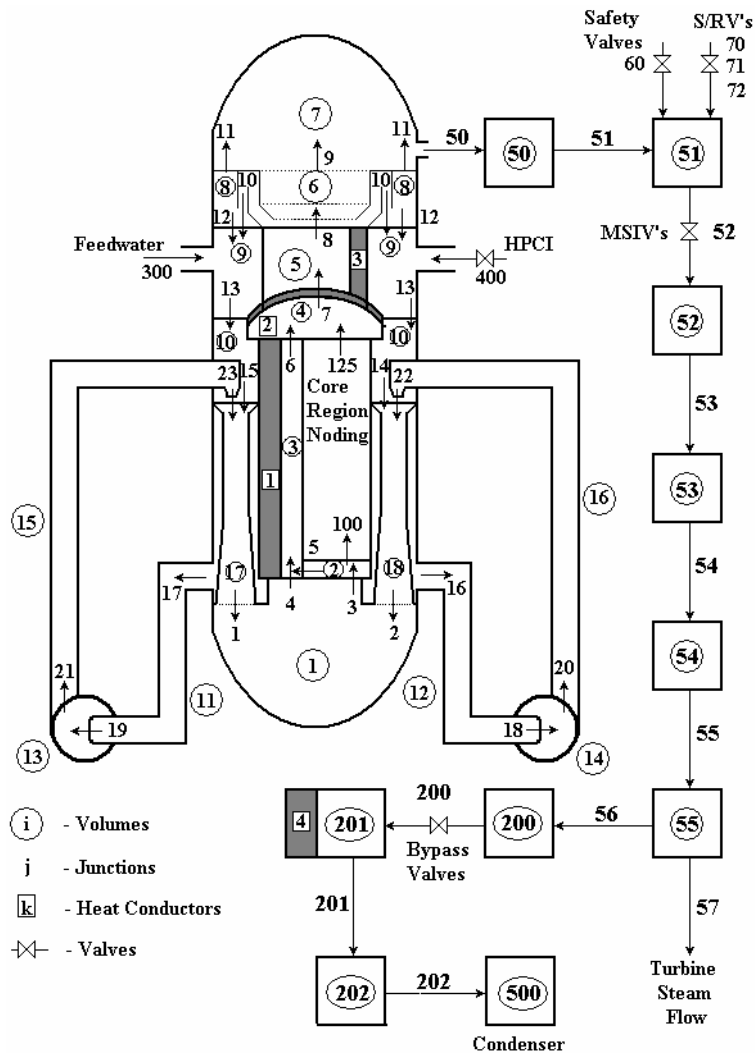

The results, which are summarised in the figures and tables contained in this chapter, indicate the importance of pressure transients for BWRs. The results also clearly establish the need for correct system input models for related system codes. Statistical evaluation of the parameters contributed to the quantitative comparative analysis.

The comparative analysis of PB2 TT2 provided detailed information on modelling challenges to system computer codes. In order to understand the comparisons and to perform meaningful analyses, the parameters should be considered in conjunction with the information provided in Appendices A and B. Appendix A provides descriptions of participant codes in terms of modelling capabilities (i.e. drift-flux models vs. six-equation or five-equation models, etc.). Appendix B provides participant responses to a questionnaire, which clarify participant nodalisations and selected modelling options.

Table 4-1 provides general information about the participant models utilised in Exercise 1. Although different numbers of channels were used by participants in their calculations, this should not significantly affect Exercise 1 results. Even one channel would be sufficient for the simulation of this exercise because the initial core average axial power profile and power time history during the transient (obtained from experimental data) were used as input data in participant models.

Correct modelling of initial steady state is important – the TT2 test has been initiated from the steady state conditions of the EOC 2. Participant results have shown excellent agreement for steady state parameters. Although CEA, NETCORP and TEPSYS predictions seem to deviate more noticeably from the reference results presented in Figures 4-1 and 4-2, the maximum deviation for the core inlet enthalpy is less than 0.7% and less than 23% for the core pressure drop. The inlet enthalpy usually depends on the amount of steam carry-under from the separators. The transient response of the system is very sensitive to separator modelling because this affects the initial location of the bulk boiling in core channels. The good agreement obtained in the core inlet enthalpy predictions is encouraging for the participants to perform further analyses. The accuracy of the core pressure drop calculations is affected by the predictions of the inlet enthalpy, which is related to the modelling of steam separators/dryers and loss coefficients in the vessel and channels. Since the inlet enthalpy predictions agree quite well, the observed discrepancies in the pressure drop predictions may come from participant models other than the separator models.

The most challenging part of the steady state analysis is the prediction of the void fraction distribution. This prediction depends on the modelling of core channels, vessel levels, steam dryers/separators, jet pumps and recirculation loops, and also depends on the features of the participant system codes. With all these challenges in mind, one can consider that the core average axial void fraction distribution results agree very well. An interesting observation can be made regarding Figure 4-5, which shows very good agreement of the average result over all participants' predictions as compared to the Exelon results. Among the void fraction results, only the FANP prediction exhibits deviation from the reference result as shown in Figure 4-3. The reason may come from the calculation of the channel and vessel loss coefficients. Most of the results have shown slight differences at the axially lower (bottom) part of the core, such as PSI's prediction (Figure 4-4). Since there is no neutronic feedback for this exercise, the slight deviations may be explained by participants' different thermal-hydraulic flow and heat transfer models and especially sub-cooled boiling models.

In summary, steady state simulation of large systems is very difficult and requires extensive work on each component's model. In addition, correct simulation is necessary of the control phenomena in input models, such as water level control, recirculation pump speed, jet pump flows, feedwater flow and steam line pressure.

The calculated transient results and the comparisons presented in this chapter not only provide an opportunity to understand the phenomena behind the turbine transient tests but also to engage in comprehensive testing and examination of the capability of participant codes to simulate such transients. During the benchmark workshops, three important decisions were made by the participants related to the comparative analysis of the time histories: 1) to analyse the time histories of delta changes (instead of absolute parameter values) in order to avoid the impact of initial steady state disagreements; 2) to provide two comparisons for 1.5 s and for 5 s; and 3) to provide two FOM estimates based on two different methods (FFT and ME).

In general, it was demonstrated that the steam bypass line has a strong interaction with the main steam line and the steam bypass line's impact on the pressure responses depends on the relative position of the TSV and BPV. It was observed that an acoustical pressure wave (oscillation) can exist in the reactor main steam piping due to the combined compressibility and momentum effects in the steam line. The fundamental mode of the acoustical pressure oscillation is strongly excited as a result of turbine trip, which causes a sharp initial pressure rise in the reactor as the first pressure wave enters the reactor vessel. In addition, the fundamental acoustical mode propagates in the main steam piping, entering the reactor vessel and passing through the steam separators into the reactor core with relatively little attenuation. All of these physical facts can be seen in participant results (Figures 4-7 through 4-40).

During analysis of the results for the first exercise, it was obvious that the sources of deviations in participant predictions came from the differences in modelling the two key parameters – pressure response and core flow response. Accurate prediction of the pressure response depends on the number of models used by a given code. Models include: the steam line model (requires adequate nodalisation and treatment of momentum effects), the steam bypass system model and the steam separator model (requires proper treatment of steam separator inlet inertia and non-equilibrium effects at steam-water surfaces). Prediction of core flow response is sensitive to the jet pump model used (requires proper representation of the dynamic response of flow-to-pressure) and the core exit/separator region model (requires proper representation of the dynamic response of two-phase flow).

Figures 4-7 through 4-18 and Tables 4-6 through 4-9 present the comparative analysis of participant vessel dome pressure and core exit pressure results with the reference data. In principle, the results are in good agreement. In particular, the good agreement in the times of occurrence of the initial rise indicates that the time effects (delays, rise times and frequencies) are modelled well. In addition, the amplitudes of the pressures are generally in good agreement. The discrepancies can be attributed to the shortcomings of the code models. For example, improving the slip model may increase the accuracy of the results because the reactor pressure vessel may have a larger liquid inventory and lower steam inventory, which tend to produce higher pressures.

If Tables 4-6 through 4-9 are analysed together, it can be concluded that some participant predictions agree well with the reference solutions in the first 1.5 seconds of the transient while other participant predictions agree well in the later part of the transient. The reason for this may be explained in the following statements. The overall behaviour of the pressure is mostly affected by the transient flow rate of steam through the turbine stop valves and bypass valves. Simulation of the opening and closing of the valves and nodalisation of the steam lines play an important role in the calculations. The discrepancies seen in the latter phases of these curves may arise from depressurisation rate mechanisms (e.g. critical flow models and steam formation models).

Participant results for jet pump flow rate (total core flow rate) and core in-channel flow rate are generally consistent as shown in Figures 4-19 through 4-30 and in Tables 4-10 through 4-13. Although the submitted results in the figures seem to have great deviations when compared with the reference data, it should be noted that the illustrated results are based on delta changes (explained in Chapter 3). If the initial values of the flow rates (such as 10 445 kg/s for total core rate) are considered, then the maximum deviation is evaluated at less than 10%.

Discrepancies in flow rate responses can be analysed in 2 sections – deviations before 1.5 seconds and after 1.5 seconds. Most problematic in the period before 1.5 seconds were predictions of peak times and peak amplitudes as well as the simulation of wave propagation. The best agreement with reference results in the flow rate prediction was achieved by the PSI results. As described in Appendix A, PSI used RETRAN-3D, which is based on the code RETRAN (used by Exelon for reference calculations).

In the latter phases of the jet pump flow rate and core in-channel flow rate figures, the NUPEC, PSU/NRC and Westinghouse predictions were ~3-5% higher than the reference solution. The most probable reason for this disagreement is the input model (if the effect of the core bypass flow model on the core flows is considered). In most models, the core bypass flow is directly related to the total core flow. For instance, a decrease in core bypass flow causes an increase in total core flow rate.

Although steam bypass modelling is one of the most challenging parts of the exercise, the submitted results have shown that participant models can simulate steam bypass flow successfully. The submitted results agree well as shown by Figures 4-31 through 4-36 and by Tables 4-14, 4-15. The predictions shown in the figures deviated at the peak time and especially at the end of the transient.

Assumptions used in modelling the phenomena between the flow through steam bypass valve and the valve opening area had a great effect on the results. In addition, the predictions were very important because the bypass flow rate itself greatly influenced peak pressures.

Predictions of the participant models are also affected by the choice of bypass piping heat transfer options [10]. As hot steam enters the bypass valves, significant heat is transferred to the cold piping walls due to the large temperature gradient. This event causes slower pressurisation of bypass piping, which increases the effects of the critical flow through the bypass valve. The heat transfer to the pipe walls causes an increase of the flow rate until walls reach the steam temperature. In most cases, pipes are cold (i.e. their temperatures are close to the condenser temperature); however, there is evidence that the piping walls remain at a high temperature for some time after steam bypass opening. Since the TT2 event followed TT1, during the opening of the bypass valves the heat transfer to the walls may be negligible [7]. Finally, it was shown that the transient flow phenomena in the steam bypass system are of great importance.

As a parameter for the time histories, turbine inlet pressure predictions were compared with the average result. All results were in quite good agreement. Some slight deviations on the initial pressure response were possibly a result of the differences in the action of TSV modelling. The modelling of this action affects the prediction of certain time effects such as delays, rise times and frequencies.

The remarkable overall good agreement between reference and participant results for time histories raised confidence in the participants' system codes as well as in the developed system models. Moreover, the excellent agreement, which is illustrated in Figures 4-9, 4-12, 4-15, 4-18, 4-21, 4-24, 4-27, 4-30, 4-33, 4-36 and 4-39, between average and reference results not only indicated the success of this benchmark but also encouraged participants to take part in the remaining exercises.

In addition to time histories, sequence of events, maximum peak times for time histories and maximum peak values can be found in Tables 4-18, 4-19 and 4-20. Although participant event timings for TSVC, BVBO and BVFO were perfect as shown in Table 4-18, initial responses had slight differences. In parallel, time and maximum peaks presented in Tables 4-19 and 4-20 had discrepancies. The possible reasons for these discrepancies were explained in the above paragraphs.

In conclusion, the results of the first exercise verified the participants' system codes and system models, and contributed to gaining a more in-depth knowledge of the capabilities of these codes. Developing a more in-depth knowledge of coupled computer code systems is important because 3-D kinetic/thermal-hydraulic codes will play a critical role in the future of nuclear analysis. Since the purpose of this exercise was to initialise and test the thermal-hydraulic system model responses, this chapter proved that this exercise laid the foundation for conducting other benchmark exercises in a consistent and systematic way.

Chapter 5

CONCLUSIONS

In order to meet the objectives for the validation of best-estimate coupled codes, a systematic approach was introduced to evaluate the turbine trip transient. Such codes use separate temporal and spatial models as well as numerical methods for core neutronics, core thermal-hydraulics and system thermal-hydraulic simulations. Therefore, the validation of the codes should include testing these models for the defined transient for a given type of reactor (BWR in this case) as separate exercises of the overall benchmark.

The ultimate goal is to enable participants to initiate and verify these models before focusing on the major objective, which is the testing of coupling methodologies in terms of numerics, temporal and spatial mesh overlays. This approach allows one to evaluate in a more consistent way the modelling of combined effects (neutronics/thermal-hydraulics as well as core/plant interactions) by removing the uncertainties introduced with separate models.

In order to perform such a comprehensive validation of coupled codes, a multi-level methodology is employed. This includes the application of three exercises, the evaluation of different steady states and the simulation of different transient scenarios.

To summarise this work, Exercise 1 of the BWR TT benchmark was discussed in detail. The results of this benchmark problem were intended to assist in the understanding of the behaviour of next generation computer codes. Overall, this benchmark has been well-accepted internationally, with 14 participants from 8 countries participating in the first exercise. The results submitted by participants of Exercise 1 were used to make comparisons and a subsequent statistical analysis. This information encompassed several types of data for thermal-hydraulic parameters at the initial steady state conditions and throughout the turbine trip transient. These included: integral parameters, 1-D axial distributions and time histories.

Due to the sensitive nature of this transient to small variations in initial parameters, the participants were advised to follow the final specifications as closely as possible. In order to avoid possible misinterpretations, the benchmark team provided further clarifications before the final results were submitted. The motivation behind such clarifications was to narrow down as much as possible the modelling differences for the initial steady state conditions as well as for the transient scenario. This strategy helped to obtain a cluster of solutions to be used as a basis for further comparative analysis.

A detailed assessment of the differences between calculated results submitted by the participants for this exercise was presented in Chapter 4 of this report. Overall, the participant results for integral parameters, core-averaged axial distributions and core-averaged time histories were in good agreement with reference solutions, especially considering the approximations in some participant models, the uncertainties of some system parameters and the difficulties in interpreting some of the measured responses. This is important from the fluid phenomena point of view because pressure and flow waves play an important role in the early phase of the response to a turbine trip.

Since core inlet enthalpy is highly sensitive to core inlet temperature, the submitted results were accepted as being in very good agreement. Besides, participant predictions for the core pressure drop were quite close to the reference value if complexities of such system models were taken into account. In the void fraction results, deviations were mostly observed in the lower (bottom) part of the core because of differences in the participants' sub-cooled boiling models. However, the average distribution calculated from the participants' submitted results almost matched the reference solution.

Generally, time history results and transient single values were in very good agreement with the reference data. Although some parameters seemed to have deviations, surprisingly, the average values matched the reference solution well. We observed that more than 10 submitted sets of data could make the comparative analysis meaningful in terms of the statistical approach.

In the time history comparisons, the deviations were mostly observed within the first 1.5 second time period after the start of the transient. Since power was provided as a function of time (to eliminate the impact of neutronic feedback effects), the deviations in the first 1.5 seconds may have come from the computer code control capabilities or from the approximations of participant models used in this transient (especially simulating the bypass phenomena).

It was demonstrated that Exercise 1 fulfilled its objective, namely, to help the participants initialise and test thermal-hydraulic system models to be used later in Exercise 3 (coupled 3-D neutron kinetics/system thermal-hydraulic calculations of PB2 TT2). In addition, the participants utilised Exercise 1 to perform a number of sensitivity studies on different modelling and numerical issues. Such investigations were aimed toward evaluation of impact of the following effects and parameters:

- *Thermal-hydraulic modelling issues:* Turbine bypass line modelling; nodalisation of vessel, steam line and steam separator region; TSV position and steam mass flow modelling; thermal-hydraulic model – number of equations; void fraction model; steam separator inertia; and jet pump modelling.
- *Thermal-hydraulic key parameters:* Feedwater temperature; jet pump parameters; void fraction in the bulk water (carry-under); core outlet pressure; active core pressure loss; core inlet temperature; core inlet mass flow without bypass flow; sub-cooling; void generation rate; and gas gap conductance.
- *Timestep size:* Fixed timestep of 6 ms versus using a variable timestep algorithm with a maximum timestep size imposed.

Exercise 1 provided the opportunity to study the impact of different thermal-hydraulic models on code predictions and to identify the key parameters for modelling a TT transient. This in turn allowed the evaluation of key parameters through the performance of sensitivity studies, which allowed the participants to develop a more in-depth knowledge of the capabilities of current generation best-estimate thermal-hydraulic system codes.

REFERENCES

- [1] Ivanov, K.N., T. Beam, A. Baratta, A. Irani, N. Trikouros, *PWR MSLB Benchmark – Final Specifications*, Nuclear Energy Agency, NEA/NSC/DOC(97)15, October 1997.
- [2] Solis, J., K.N. Ivanov, B. Sarikaya, A. Olson, K. Hunt, *Boiling Water Reactor Turbine Trip (TT) Benchmark Volume I: Final Specifications*, Nuclear Energy Agency of the Organisation for Co-operation and Development, NEA/NSC/DOC(2001)1, June 2001.
- [3] “Transient and Stability Tests at Peach Bottom Atomic Power Station Unit 2 at End of Cycle 2”, General Electric Company/Nuclear Energy Engineering Division, NP-564, Research Project 1020-I, Topical Report, June 1978.
- [4] Larsen, N.H., “Core Design and Operating Data for Cycles 1 and 2 of Peach Bottom 2”, EPRI NP-563, June 1978.
- [5] Carmichael, L.A., R.O. Niemi, “Transient and Stability Tests at Peach Bottom Atomic Power Station Unit 2 at End of Cycle 2”, EPRI NP-564, June 1978.
- [6] Hornyik, K., J.A. Naser, “RETRAN Analysis of the Turbine Trip Tests at Peach Bottom Atomic Power Station Unit 2 at the End of Cycle 2”, EPRI NP-1076-SR Special Report, April 1979.
- [7] Olson, A.M., “Methods for Performing BWR System Transient Analysis”, Philadelphia Electric Company, Topical Report PECo-FMS-0004-A (1988).
- [8] Kuntz, R.F., G.F. Kasmala, J.H. Mahaffy, “Automated Code Assessment Program: Technique Selection and Mathematical Prescription”, Applied Research Laboratory, Pennsylvania State University, Letter Report 3 to US NRC, April 1998.
- [9] Cubic_spline for Excel workbook, SRS1 Software, February 2003. Available at the website <http://www.srs1software.com>.
- [10] Akdeniz, B., K.N. Ivanov, “Analysis and Sensitivity Studies of Exercise 1 of OECD/NRC BWR TT Benchmark”, TANSO 87 (2002).
- [11] Ambrosini, W., R. Bovalini, F. D’Auria, “Evaluation of Accuracy of Thermal-hydraulics Code Calculations”, *Energia Nucleare*, Vol. 7, No. 2 (1990).

Appendix A

**DESCRIPTION OF COMPUTER CODES USED FOR ANALYSIS
OF EXERCISE 1 OF THE NEA-NRC BWR TT BENCHMARK**

CATHARE (CEA, France)

The development of the CATHARE code was initiated in 1979 [1]. Code objectives include:

- Perform safety analyses with best-estimate calculations of thermal-hydraulic transients in pressurised water reactors.
- Quantify the conservative analysis margin.
- Investigate plant operating procedures and accident management.
- Evaluate usage as plant analyser in full-scope training simulator providing real-time calculation.

The code is based on a two-fluid six-equation model. The presence of non-condensable gases can be modelled by one to four additive transport equations. The code is able to model any kind of experimental facility or PWR, and is usable for other reactors (fusion reactor, BWRs, etc.)

The CATHARE code applications have been extended by coupling with other codes:

- Three-dimensional neutronics code – CRONOS [2].
- Core thermal-hydraulic code (component code) – FLICA [3].
- Severe accident code – ICARE2 [4].

CATHARE Main features

CATHARE has a modular structure. The modules are:

- One-dimensional module to describe pipe flow.
- Volume module, which is a two-node module.
- Three-dimensional module to describe multi-dimensional effects in the vessel.

To complete the modelling of the circuits, sub-modules can be connected to the main modules (e.g. the multi-layer wall module), the point neutronics module, valves, safety valves, check valves, flow limiters, boundary conditions, etc.

Physical description

All modules use the two-fluid model to describe steam-water flows and four non-condensable gases that may be transported. Both thermal and mechanical non-equilibrium of the two phases are described.

All kinds of two-phase flow patterns are modelled [5]. Heat transfer with wall structures and fuel rods are calculated, taking into account all heat transfer processes: natural and forced convection with liquid or gas, sub-cooled and saturated nucleate boiling, critical heat flux, film condensation for effects of non-condensable gases, etc.

The range of parameters is rather large: pressure from 0.1-25 MPa, gas temperature from 20-2 000°C, fluid velocities up to supersonic conditions and duct hydraulic diameters from 0.01-0.75m.

System of equations

Mass, momentum and energy equations are established for any CATHARE module. They are written for each phase. They are derived from exact local instantaneous equations, using some simplification through physical assumptions as well as time and space averaging procedures. One to four transport equations can be added when non-condensable gases are present.

Physical models are required to close the system of equations for CATHARE. Closure relationships concern mass, momentum and energy exchanges between phases and between each phase and the wall. As much as possible, physical closure laws are developed on an experimental basis.

Numerical scheme and solution procedure

The numerical method in the CATHARE code uses a first order finite volume/finite difference scheme with a staggered mesh and donor cell principle. The time discretisation varies from the fully implicit discretisation used in the 0-D and 1-D modules to the semi-implicit scheme used in the 3-D module. Wall conduction is implicitly coupled to hydraulic calculations.

The non-linear system of equations is solved by a Newton-Raphson iterative method. In the last version of CATHARE (v1.5), the solution can be distributed over several processors in order to reduce the CPU time by parallel computing.

References

- [1] Houdayer, G., J.C Rousseau, B. Brun, "The CATHARE Code and its Qualification on Analytical Experiments", 10th Water Reactor Safety Research Information, Washington, October 1982.
- [2] Lautard, J.J., S. Loubiere, C. Magnaud, "CRONOS: A Modular Computational System for Neutronic Core Calculations", IAEA meeting, Cadarache, France (1990).
- [3] Toumi, I., A. Bergeron, D. Gallo, E. Royer, D. Caruge, "FLICA4: A Three-dimensional Two-phase Flow Computer Code with Advanced Numerical Methods for Nuclear Applications", *Nuclear Engineering and Design*, 200, 139-155 (2000).
- [4] Guillard, V., F. Fhicot, P. Boudier, M. Parent, R. Roser, "ICARE/CATHARE Coupling: Three-dimensional Thermal-hydraulics of Severe LWR Accidents", ICONE9, Nice Acropolis, France (2001).
- [5] Bestion, D., "The Physical Closure Laws in the CATHARE Code", *Nuclear Engineering and Design*, Vol. 124, pp. 229-245 (1990).

S-RELAP5 (FANP, Germany)

S-RELAP5 is the standard tool of FRAMATOME ANP for the investigation of accident scenarios in nuclear power plants, both of PWR and BWR. The range of applications covers LBLOCA on the one end and reactor transients on the other end. S-RELAP5 includes all features of the RELAP5 code family. It is a highly modular code where the user defines the granularity of the analysis by defining an appropriate noding scheme.

The hydraulic part of such a noding scheme includes a concatenation of hydraulic volumes connected by junctions. In the case of a two-phase state in the hydraulic volume, thermal non-equilibrium is assumed. The two-phase flow between the volumes is non-homogeneous; the corresponding phasical velocities are determined by solving momentum equations. This approach requires the definition of local static pressure, with the pressure gradient being the source of movement for each phase. Thermal properties as densities or internal energies are locally defined. In S-RELAP5, flow maps and heat transfer modes are defined; they allow for the application of constitutive relations as inter-phasical shear or heat transfer coefficients, which depend on them. A highly sophisticated numerical solution scheme allows for the consideration of hydraulic systems with up to 500 hydraulic volumes. S-RELAP5 has a fully developed fuel model and a point kinetic model.

ATHLET (GRS, Germany)

The system code ATHLET is applied for analysis of behaviour of the whole plant under accident conditions. It is a thermal fluid dynamic system code based on 1-D pipe components with a wide range of applications. The applications are comprised of anticipated and abnormal plant transients, small and intermediate leaks as well as large breaks in PWRs and BWRs. The code offers the possibility of choosing between different models of fluid dynamics. The two-phase flow can be described with up to a full six-equation model for mass, energy and momentum of both phases, including models for non-condensables. A boron tracking model for single and two-phase flow has been implemented. The code structure is highly modular and allows for easy implementation of different physical models. The basic modules include: thermo-fluid dynamics, neutron kinetics, general control simulation module and numerical integration method FEBE. ATHLET provides a modular network approach for the representation of a thermal-hydraulic system. The possibility to implement connections among a group of parallel channels in the reactor core allows for the modelling of cross flow inside the reactor core.

DNB/3D (NETCORP, USA)

DNB/3D is a FORTRAN 77 computer program that simulates the nuclear steam supply system of a boiling water reactor under transient conditions. Geometry and system component options are provided to represent any of the current BWR designs. The major features of DNB/3D are as follows:

- Point, 1-D and 3-D neutronic kinetics models including Doppler, moderator density and control rod feedback along with standard decay heat models. Initially, sub-critical cores can be represented. A power forced option is also provided.
- Multi-node radial and axial coolant channels and fuel rods.
- Fixed nodalisation in the reactor vessel and steam lines.
- One-dimensional homogeneous equilibrium conservation of mass, energy and momentum.

- Mechanistic non-equilibrium flow quality or profile fit model option to represent slip with the coolant channels.
- Steam line includes representation of the MSIV, turbine control and stop valves, RSV and steam bypass valves.
- Method of characteristics used to solve conservation equations in the steam lines.
- Turbine representation.
- Structural metal components represented. Reactor protection and safety systems represented.
- Control systems represented. Complete self-initialisation of all components and models.
- Provisions to represent a wide variety of transient and accident scenarios. Flexible restart capability. British or SI input/output option.

TRAC-BF1 (NFI, Japan)

The code used in the first exercise is TRAC-BF1/MOD1. TRAC-BF1/COS3D is not used in this exercise but in the others. TRAC-BF1 is a best-estimate transient analysis code for analysing the full range of postulated accidents in boiling water reactor systems and related facilities.

TRAC-BF1 (NUPEC, Japan)

NUPEC used the TRAC-BF1 code in the first exercise. TRAC-BF1 is the latest public domain BWR version of TRAC, which deals with thermal hydraulics, fuel heat transfer and plant system. Thermal-hydraulics utilises the two-fluid model that solves six balance equations of mass, momentum and energy for liquid and vapor phases. Two-phase flow in the core region is treated as 1-D parallel vertical flows. The heat transfer model solves 1-D radial heat conduction equations. Heat transfer coefficients at the cladding surface are subdivided into each flow regime. Material properties are based on the code-installed MATPRO correlations. TRAC-BF1 has major BWR component modules: vessel, channel, separator/dryer, pump, pipe, valve, etc. The plant system can be composed of these component modules. The reactor pressure vessel is modelled with the vessel component in 3-D cylindrical co-ordinates. Two numerical methods for thermal-hydraulic calculations are used. The first is the standard finite differential method with staggered mesh, which is used for the space integration of both fluid flow and heat conduction. The second is the time integration of fluid flow equations, which is performed by the semi-implicit scheme with the stability enhanced two-step (SETS) method.

RETRAN-3D (PSI, Switzerland)

Within the STARS project at PSI, the code environment for the coupled 3-D reactor-kinetics/thermal-hydraulics transient analyses of Swiss LWRs is based mainly on RETRAN-3D and CORETRAN for both PWR and BWR systems. (Note that other codes are used for specific applications, e.g. RAMONA for BWR stability.) Both codes play distinct roles in this environment – RETRAN-3D is used for analysis of coupled 3-D core/plant system transients while CORETRAN is

used for core-only dynamic analysis. An important aspect is that both codes are based on an identical neutronics algorithm, allowing usage of CORETRAN as an interface code to help prepare the 3-D core model for RETRAN-3D. This approach forms the basis of PSI 3-D transient analysis methodology.

Participation in the OECD/NRC Peach Bottom 2 Turbine Trip Benchmark was prompted by the following considerations. First, the PSI methodology so far has only been assessed for neutronically driven transients and for a PWR system transient. Since the benchmark addresses a BWR transient driven by system thermal-hydraulic perturbations, it extends the range of code assessment. Secondly, the benchmark incorporates three different phases, which are well-suited to a comprehensive assessment of all the participating codes, according to the PSI viewpoint. Consequently, PSI participated in all three phases of the benchmark.

RETRAN-3D MOD003.1, which is used in phase 1 of the benchmark, was developed by EPRI to perform licensing and best-estimate transient thermal-hydraulic analyses of light water reactors and is maintained by CSA/USA. RETRAN-3D is used to analyse thermal-hydraulic transients and requires numerical input data that completely describe the components and geometry of the system being analysed. Input data include fluid volume sizes, initial flow, pump features, power generation, heat exchanger properties and material compositions. RETRAN-3D can calculate a steady state initialisation from a minimal amount of information. The steady state option computes volume enthalpies from a steady state energy balance with the restriction that only one enthalpy may be supplied per flow system. The range of applications of RETRAN-3D also includes the spatial kinetics behaviour of multi-dimensional reactor cores. RETRAN-3D permits the analysis of systems with non-equilibrium thermo-dynamic conditions and allows for the presence of non-condensable gases in the fluid stream.

TRAC-BF1/MOD1 (PSU, USA)

TRAC-BF1/MOD1: An advanced best-estimate computer program for boiling water reactor accident analysis [1]

The TRAC-BWR Code Development Program at the Idaho National Engineering Laboratory (INEL) is a program that develops versions of the Transient Reactor Analysis Code (TRAC) to provide the US Nuclear Regulatory Commission and the public with best-estimate capability for the analysis of accidents and transients in boiling water reactor systems and related experimental facilities. This effort began in October 1979 and resulted in the first publicly released version of the code, TRAC-BD1 v1-1 which was sent to the National Energy Software Center in February 1981. The mission of this first version of the code was to provide best-estimate capability for the analysis of design basis loss-of-coolant accidents (LOCAs) in BWRs. The code provided a unified and consistent treatment of the design basis LOCAs sequence beginning with the blowdown phase, through heatup, then reflood with quenching and, finally, refill phase of the LOCAs scenario. New models developed for TRAC-BD1 in order to accomplish its mission included: a) a full two-fluid, non-equilibrium, non-homogeneous thermal-hydraulic model of two-phase flow in all parts of the BWR system, including a 3-D treatment of the BWR pressure vessel; b) a detailed model of a BWR fuel bundle, which includes other models (a radiation heat transfer model for thermal radiation between multiple fuel rod groups, the inner surface of the channel wall and the liquid and steam phases in the channel; a leakage path model; and a quench front-tracking capability for both falling films and bottom flooding quench fronts on all rod groups and the inner surface of the channel wall); c) simplified models of BWR hardware components such as the jet pump and separator/dryer; d) a counter current flow-limiting model for BWR geometries; e) a non-homogeneous critical flow model; and f) flow regime-dependent constitutive relations for the transfer of mass, energy and momentum between the liquid and steam phases in two-phase flow and between each phase and structure.

The mission of the second publicly released version of the code, TRAC-BD1/MOD1, was expanded to include not only large and small-break LOCAs but also operational transients and anticipated transients without scram (ATWS) to which point reactor kinetics is applicable. Models developed to support the broadening of the mission scope for the TRAC-BWR codes included:

- Balance of plant models such as turbine, feedwater heaters and condenser.
- A simple lumped parameter containment model.
- Reactivity feedback model for use in the point reactor kinetics model.
- Soluble boron transport model.
- Non-condensable gas transport model.
- Two-phase level tracking model.
- Control systems model.
- Generalised component-to-component heat and mass transfer models.
- Improved constitutive models for the transfer of mass, energy and momentum between the two phases and between the phases and structure.

User convenience features, such as free-format input and extensive error checking of the input data, were also included in TRAC-BD1/MOD1.

The mission of TRAC-BF1/MOD1 is the same as for TRAC-BD1/MOD1, but the new capabilities built into this code make it more suitable for that mission. The new models and capabilities in TRAC-BF1/MOD1 include:

- Material courant limit violating numerical solution for all 1-D hydraulic components.
- Implicit steam separator/dryer model.
- Implicit turbine model.
- Improved interfacial heat transfer.
- Improved interfacial shear model.
- A condensation model for stratified vertical flow.
- One-dimensional neutron kinetics model.
- Improved control system logic and solution method.

In addition to these code improvements, a pre-load processor was written for TRAC-BF1, its graphic routines were improved for adaptation to the Nuclear Plant Analyzer (NPA) at INEL, and more than 95% of the coding was converted to ANSI Standard FORTRAN 77.

TRAC-BF1/MOD1 can be applied to any BWR accident analysis or thermal-hydraulic test facility, including those requiring reactivity feedback effects, control system simulation and/or balance of plant model. TRAC-BF1/MOD1 has been applied to experimental facilities from simple pipe blowdowns (e.g. Edwards pipe tests) to integral LOCA tests [e.g. two-loop test apparatus (TLTA) facility] and even to multi-dimensional test facilities [e.g. slab core test facility (SCTF)]. BWR small-break LOCAs have also been simulated with TRAC-BD1. The BWR fuel bundle model is quite versatile and has been used to simulate not only BWR fuel bundles within a BWR reactor vessel but also stand-alone, single-bundle experiments in which advanced bundle hydraulics and heat transfer models are required.

Reference

- [1] Giles, M.M., G.A. Jayne, S.Z. Rouhani, R.W. Shumway, G.L. Singer, D.D. Taylor, W.L. Weaver, "TRAC-BF1/MOD1: An Advanced Best-estimate Computer Program Boiling Water Reactor Accident Analysis Volume 1: Model Description", NUREG/CR-4356 EGG-2626, pp. 1-1, 1-2, May 1992.

TRAC-M (PSU/NRC, USA)

TRAC-M performs best-estimate analyses of loss-of-coolant accidents and other accident and operational transients in pressurised light water reactors as well as neutronic thermal-hydraulic experiments in reduced-scale facilities. Models used include multi-dimensional two-phase flow, non-equilibrium thermo-dynamics, generalised heat transfer, reflood and reactor kinetics. Automatic steady state and dump/restart capabilities are also provided.

The partial differential equations that describe two-phase flow and heat transfer are solved by finite differences. The heat transfer equations are evaluated using a semi-implicit time-differencing technique. The fluid dynamics equations in the spatial 1-D, 2-D and 3-D components use a multi-step time-differencing procedure that allows the material courant limit condition to be exceeded. The finite difference equations for hydrodynamic phenomena form a system of coupled, non-linear equations that are solved by the Newton-Raphson iteration method. The resulting linearised equations are solved by direct matrix inversion. For the 1-D network matrix, this is done via a direct full matrix solver. For multiple vessel matrix, this is done via the capacitance matrix method using direct banded matrix solver.

The number of reactor components in the problem and the manner in which they are coupled is arbitrary. Reactor hydraulic components in TRAC-M include PIPEs, PLENUMs, PRIZERs (pressurisers), PUMPs, TEEs, VALVEs, and VESSELs with associated internals. HSTR (heat structure) SLAB and ROD components are available to compute 2-D conduction and surface convection heat transfer in Cartesian and cylindrical geometries. FILL and BREAK components are used to apply the desired coolant flow and pressure boundary conditions, respectively, for TRAC-M steady state and transient calculations. There are also the SEPD (separator) and TURB (turbine, TRAC-M/F77 only) components, which are to be replaced in the future TRAC-M/F90 development. The current status of SEPD and TURB is indicated as appropriate in this document. Additional component models that are under development are indicated later in this section.

The TRAC-M computer execution time is highly problem-dependent and is a function of the total number of mesh cells, the maximum allowable timestep size and the rate of the neutronic thermal-hydraulic phenomena being evaluated. For TRAC-PF1 and later versions, stability-enhancing two-step numerics in 1-D hydraulic components allowed the material courant limit to be exceeded. This enabled the usage of very large timesteps in slow transients when only 1-D hydraulic components

are modelled. In TRAC-PF1/MOD2 and later versions, SETS numerics were also applied to the multi-dimensional VESSEL component to allow the material courant limit to be exceeded and very large timesteps to be used for all system models. This facilitates significant speedups of one or two orders of magnitude for slow accident and operational transients when multi-dimensional VESSEL components need to be modelled.

Reference

- [1] Steinke, R.G., V. Martinez, N.M. Schnurr, J.W. Spore, J.V. Valdez, “TRAC-M/FORTRAN 90 (Version 3.0) User’s Manual”, NUREG/CR-6722, pp. 2-1, 2-2, May 2001.

TRAC-BF1-ENTRÉE (TEPSYS, Japan)

TRAC-BF1-ENTRÉE is a parallel coupled system of the highly accurate 3-D neutron kinetic code ENTRÉE and the versatile BWR simulator TRAC-BF1.

TRAC-BF1

The version we applied is basically the same as that used by other participants. The modifications made by TEPSYS are:

1. Coupling interface with ENTRÉE.
2. Original direct heating model that works in co-operation with ENTRÉE.
3. Neutron kinetics integration timestep controlling algorithm that works in co-operation with ENTRÉE.
4. Modifications in the control block INTM for modelling the SRV movement (Figure A-1).

ENTRÉE

ENTRÉE solves the two-energy group 3-D diffusion equation based on the transverse integrated nodal expansion method. The higher order bundle flux is expanded either with the Legendre polynomial functions or the Legendre semi-analytical functions. In this study, the non-linear iteration method with Legendre semi-analytical functions will be applied because of its high level of accuracy. Communication between two codes is realised by the PVM (parallel virtual machine) protocols, which enable synchronisation of data sending and receiving in two processes.

Important numerical options together with plant valve parameters applied in this study are summarised in Table A-1.

Table A-1. TEPSYS reference numerical options in ENTRÉE and valve parameters

Numerical options in ENTRÉE	
Solution method	Non-linear iteration method
Neutron flux expansion function	Legendre semi-analytical functions
Transverse integrated flux	Quadratic polynomials
Assembly discontinuity factor	Yes
Decay heat model	ANS-1979
Moderator direct heating	Yes
Number of thermal-hydraulic regions	33 (in-channel) + 2 (bypass)
Cross-section library	NEA single table format (functions of only instantaneous variables)
Valve parameters	
Turbine stop valve	Closing delay time = 0 s Closing stroke time = 96 ms
Turbine bypass valve	Opening delay time = 60 ms Opening stroke time = 786 ms
Safety relief valves (pressure set points and flow capacities specified in Ref. [4])	Relief valve opening delay time = 400 ms Relief valve opening stroke time = 150 ms Relief valve closing delay time = 0 ms Relief valve closing stroke time = 0 ms Safety valve opening delay time = 0 ms Safety valve opening stroke time = 300 ms Safety valve closing delay time = 0 ms Safety valve closing stroke time = 0 ms

Figure A-1. TEPSYS modifications in control block INTM

INTM Misworking in Control Block - TRAC-BF1

- **Usage definition of INTM in TRAC-BF1 Specification:**

CNTRL200xx	INTM	X1	L2	L3	I/O
CNTRL210xx	XIV	N/A	N/A	G	XMAX XMIN
- **Function Definition**
 - L2 = L3 = 0 : Integration = 0
 - L2 = L3 = 1 : Integration = Working on.
- **Misworking:**
 - Setup of L3=Arbitrary value
 - Output of L3 = 0
 - Integration does not work.
- **Compulsory Improvement in TEPSYS**
 - Error Subroutine : conblk.f
 - Compulsory Improvement: L2=L3
 - (Only for calculation of BWR-TT Extreme scenarios in TEPSYS)

Error Report has been submitted to NRC.

BWR-TT5, 21-22, Jan, 03, Spain **TEPCO System Corporation, Japan** **TEPSYS**

RELAP5 (UPISA, Italy)

The light water reactor transient analysis code, RELAP5, was developed at the Idaho National Engineering Laboratory for the US Nuclear Regulatory Commission. Code uses include: analyses required to support rulemaking, licensing audit calculations, evaluation of accident mitigation strategies, evaluation of operator guidelines and experiment planning analysis. RELAP5 has also been used as the basis for a nuclear plant analyser. Specific applications have included simulations of transients in LWR systems such as loss-of-coolant, anticipated transients without scram and operational transients (e.g. loss of feedwater, loss of offsite power, station blackout and turbine trip). RELAP5 is a highly generic code that, in addition to calculating the behaviour of a reactor coolant system during a transient, can be used for simulation of a wide variety of hydraulic and thermal transients in both nuclear and non-nuclear systems involving mixtures of steam, water, non-condensables and solutes.

The RELAP5/MOD3 code is based on a non-homogeneous and non-equilibrium model for the two-phase system and is solved by a fast, partially implicit numerical scheme to permit economical calculation of system transients. The objective from the outset of the RELAP5 development effort was to produce a code that included important first-order effects necessary for the accurate prediction of system transients but that was also sufficiently simple/cost effective for parametric/sensitivity studies.

The code includes many generic component models from which general systems can be simulated. The component models include pumps, valves, pipes, heat-releasing or absorbing structures, reactor point kinetics, electric heaters, jet pumps, turbines, separators, accumulators and control system components. In addition, special process models are included for effects such as form loss, flow at an abrupt area change, branching, choked flow, boron tracking and non-condensable gas transport.

The system mathematical models are coupled into an efficient code structure. The code includes extensive input checking capability to help the user discover input errors and inconsistencies. Also included are free-format input, restart, renodalisation and variable output edit features. These user conveniences were developed in recognition that the major cost associated with the use of a system transient code is the engineering labour/time involved in accumulating system data and developing system models, while the computer cost associated with the generation of final results is usually small.

The development of models and code versions that constitute RELAP5 has spanned ~17 years, from the early stages of the RELAP5 numerical scheme development to the present. RELAP5 represents the aggregate accumulation of experience in modelling reactor core behaviour during accidents, two-phase flow processes and LWR systems. Code development has benefited from extensive application and comparison to experimental data in LOFT, PBF, Semiscale, ACRR, NRU and other test programs. The latest version used in the Peach Bottom BWR TT Benchmark is RELAP5/MOD3.3.

TRAC-BF1-VALKIN (UPV, Spain)

The coupled code is called TRAC-BF1-VALKIN and it can be used to simulate transients while considering neutronic phenomena in 3-D geometry and thermal-hydraulic processes in multiple channel 1-D geometry.

TRAC-BF1

As the thermal-hydraulic code we used the best-estimate code TRAC-BF1, which has a two-fluid, six-equation model to account for the thermal-hydraulic phenomena.

To model the heat transfer in the fuel, an axial-radial heat transfer equation is utilised. The thermal-hydraulics processes are modelled solving six balance equations of mass, momentum and energy for liquid and vapour phases. For the numerical integration of the fluid flow equations, a semi-implicit two-step method is used for time discretisation and a first order finite difference method with staggered mesh is applied to discretise the spatial portion of the equations.

VALKIN

The neutronic code used is the VALKIN module. This module has two options, MODKIN and NOKIN. MODKIN is based on a nodal modal method to integrate the time-dependent neutron diffusion equation in the approximation of two energy groups. It is also based on the expansion of the neutronic flux in terms of the dominant lambda modes of a given configuration of the reactor core. NOKIN option uses a one-step backward discretisation of the neutron diffusion equation.

NEM

Neutronic code NEM was used to compare the results obtained from the VALKIN code. NEM is a 3-D kinetic code based on the nodal expansion method.

POLCA-T (Westinghouse, Sweden)

POLCA-T is a coupled 3-D core neutron kinetics and system thermal-hydraulics computer code [1]. The code is able to perform steady state and transient analysis of BWR. To varying extents, the code is based on models and tools for BWR and PWR analysis used in the POLCA7 [2], BISON and RIGEL codes [3]. The code utilises new advanced methods and models in neutron kinetics, thermal-hydraulics and numerics. The main features of the code can be summarised as follows:

- Full 3-D model of the reactor core. The neutronic models in the code are the same as those in the well-known static core analyser POLCA7 with the addition of a proper 3-D kinetics model.
- Advanced five-equation thermal-hydraulic model with a thermal non-equilibrium description of the steam-water mixture and its coupling to the heat structures. Separate mass and energy balances of the phases. Drift flux model that can handle all flow regimes.
- Heat transfer model that also works in post-dryout.
- The gas phase consists of steam and non-condensable gases. The liquid phase contains dissolved non-condensable gas.
- Boron transport model.
- Use of the same thermal-hydraulics model for core and plant systems.
- Two-dimensional fuel rod heat transfer model, gas gap model consistent with design code and complete range of heat transfer regimes. The code is able to model all plant heat structures.
- Dryout and DNB correlations (using pin power distributions model).

- Full geometrical flexibility of the code: volume cells, flow paths, heat structures, materials, pumps, measurements, controls, etc. are all input data. Code is able to analyse different power plants and test facilities.
- Balance of plant, control and safety systems: reactor pressure vessel, external pump loops, steam system, feedwater system, ECC systems and steam relief system are modelled to desired detail. A large and valuable set of existent input models can be used.
- Stable numerical method that allows long timesteps, which is also used for a steady state solution. Low dependence on the size of the timestep since the implicit numerical integration is close to second order by means of θ -weighting.

Due to the above mentioned features, the POLCA-T code makes possible a comprehensive approach to plant analysis with full consistency in steady state and transient calculations. Consistency in BWR core and system modelling, when transient analyses are performed, is achieved by using the same basic model and the same design database for core data (cross-section data, burn-up, xenon and other 3-D distributions obtained from depletion calculations), fuel thermal-mechanical behaviour (properties) and system data. Thus, full consistency is also possible between predicted core and system parameters and their behaviour in a very wide range of phenomena and processes important both for design and safety analyses.

Application areas of the POLCA-T code consist of three groups: 1) BWR steady state core design, 2) BWR stability, transients and accident analyses and 3) modelling of experimental test facilities.

Applications for BWR steady state core design are covered by POLCA7's broad capabilities:

- Evaluation of reactivity and power distribution at cold and hot core conditions.
- Detailed thermal-hydraulic analysis.
- Control operations (reactivity search modes including boron, power, flow, control rod, axial offset and minimum boron control).
- Detector simulation.
- Evaluation of fuel pins, pellet powers and burn-up.
- Evaluation of peaking factors based on pin results.
- Dryout and DNB margin calculations (based on pin power distributions).
- Fission heat load parameters (margins) calculations.
- Pellet cladding interaction calculations.
- Depletion calculation with tracking of most important fissile isotopes and fission products.
- Fuel bundle, control rod, fuel channel and fixed in-core detector depletion.
- Shutdown margin evaluation.

- Shutdown cooling.
- Xenon transients.
- Reactivity coefficients (void, burn-up and moderator temperature).

Applications for BWR safety analysis include operational transient, stability, RIA, ATWS, ATWC and LOCA as follows:

- Feedwater flow increase/temperature decrease transients.
- Loss of feedwater flow transients.
- Pressure increase transients – analysis on cladding.
- Pressure increase transients – analysis on the reactor coolant pressure boundary.
- Pressure decrease transients.
- Recirculation flow increase transients.
- Recirculation flow decrease transients.
- Control rod withdrawal error.
- Inadvertent loading transients.
- Control rod drop accident.
- Stability analysis.
- Anticipated transients without scram.
- Anticipated transients without control rods (ATWC).

The POLCA-T code is well-adapted to analyse the type of scenarios with a number of failing control rods. The boron transport model makes it possible to analyse different types of boron shutdown scenarios. Applications for the modelling of separate test facilities (e.g. FRIGG) are foreseen not only for code validation but also for pre-test analysis and experiment planning and optimisation.

References

- [1] Panayotov, D., U. Bredolt, P. Jerfsten, “POLCA-T – Consistent BWR Core and Systems Modelling”, ANS/AESJ/ENS *Int. Conf. Top Fuel 2003*, Paper 410, Wurzburg, Germany, 16-19 March 2003.
- [2] Lindahl, S-Ö., E. Müller, “Status of ABB Atom’s Core Simulator POLCA”, *Int. Conf. PHYSOR96*, Mito, Japan, 16-20 September 1996.

- [3] Wijkström, H., “ABB Atom’s New Code for 3D Static and Transient Analysis”, *Proceedings of the German Nuclear Society Workshop on Thermal and Fluid Dynamics, Reactor Physics and Computing Methods*, Rossendorf, Germany, 31 January through 1 February 2000.
- [4] Panayotov, D., “OECD/NRC BWR Turbine Trip Benchmark: Simulation by POLCA-T Code”, *PHYSOR2002 International Conference on the New Frontiers of Nuclear Technology: Reactor Physics, Safety and High-Performance Computing*, Track H-2, Paper 3C-02, Seoul, Korea.

Appendix B

**QUESTIONNAIRE FOR EXERCISE 1 OF
THE NEA-NRC BWR TT BENCHMARK**

QUESTIONNAIRE FOR EXERCISE 1

1. *Thermal-hydraulic model and nodalisation of the vessel and balance of the plant*

- a) *What kind of nodalisation is used (1-D, 3-D and number of T-H channels or cells)?*
- b) *How are the volumes, junctions and channels/T-H cells chosen? (If possible, please provide schematic.)*
- c) *Please provide in detail the nodalisation of the steam line.*

2. *Boundary conditions*

- a) *Which core thermal-hydraulic initial and transient boundary conditions are used and how?*
- b) *Which neutronic/power initial and transient boundary conditions are used and how?*

3. *Component design and modelling*

- a) *How many core bypass channels are used in this exercise?*
- b) *How are the jet pumps modelled?*
- c) *How is the steam separator modelled?*
- d) *How are the turbine stop valve closing and steam bypass system modelled?*
- e) *What were the difficulties encountered during the component design modelling?*

4. *General*

- a) *Deviations from the updated final specifications?*
- b) *User assumptions? Please provide the timestep(s) size or maximum and minimum values used for the simulation of Exercise 1.*
- c) *Specific features of the codes used?*
- d) *Number of solutions submitted per participant and how they differ?*
- e) *If your results are significantly different ($> 3\sigma$) than the measured or Exelon results, are there any explanations for these differences? Please explain each significant difference.*

CATHARE2 v1.5 (CEA, France)

1. Thermal-hydraulic model and nodalisation of the vessel and balance of the plant

a) *What kind of nodalisation is used (1-D, 3-D and number of T-H channels or cells)?*

Reactor pressure vessel is modelled by 1-D and 0-D connected modules. Core is represented with one 1-D channel using 24 nodes.

b) *How are the volumes, junctions and channels/T-H cells chosen? (If possible, please provide schematic.)*

Big components like plenums and condenser are modelled by 0-D modules. The core, standpipes, downcomer, recirculation loops and steam lines are represented with 1-D modules. Junctions enable to connect each 1-D and 0-D component.

Figure B-1. CEA nodalisation diagram

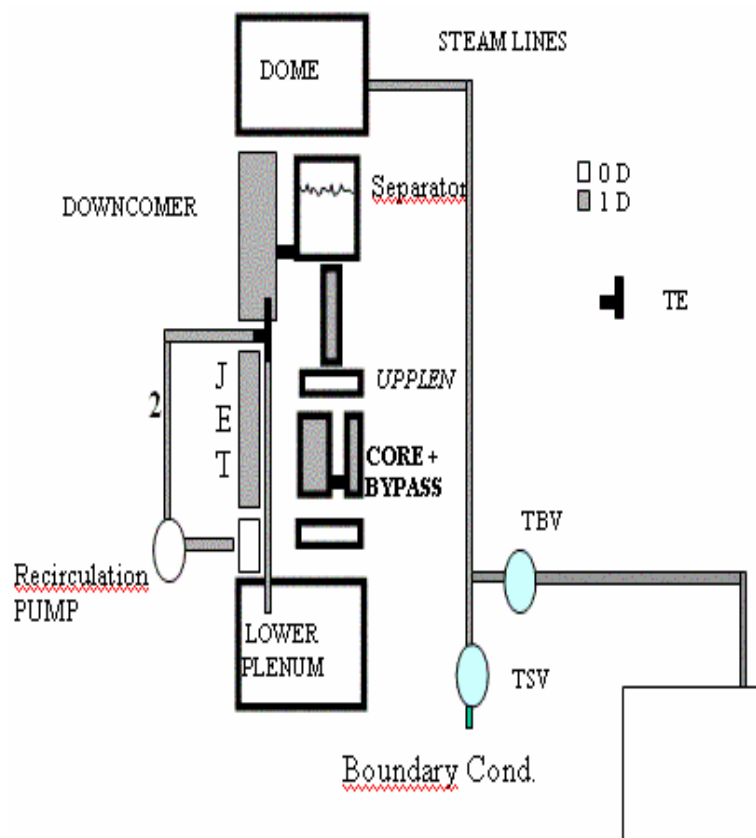

c) *Please provide in detail the nodalisation of the steam line.*

All parameters such as diameters, lengths and volumes are based on RETRAN skeleton deck of BWR TT specifications [NEA/NSC/DOC(2001)1, Appendix A, Skeleton Input Deck].

The steam line between RPV and TSV is meshed with 200 elements (length of each element ~1 meter). The steam line between TBV and condenser has 100 elements.

2. **Boundary conditions**

a) *Which core thermal-hydraulic initial and transient boundary conditions are used and how?*

A steady state condition is achieved by controlling the mass flow rate in the core and in the recirculation loops as well as by controlling the pressure in the steam dome.

The boundary conditions are:

- Feedwater flow rate.
- Pressure downstream to the TSV.
- Core power (axial distribution).

Transient boundary conditions are:

- Evolution of feedwater flow.
- Evolution of power.
- Loss coefficient for TSV and BPV in order to respect closing and opening dynamics given by BWR TT benchmark specifications.

b) *Which neutronic/power initial and transient boundary conditions are used and how?*

Power initial and transient boundary conditions given in BWR TT specifications are used (i.e. see file *nfpower_exercise1*).

3. **Component design and modelling**

a) *How many core bypass channels are used in this exercise?*

One core bypass channel is used for Exercise 1.

b) *How are the jet pumps modelled?*

Jet pumps are modelled by 1-D and TE modules, taking into account momentum source.

c) *How is the steam separator modelled?*

The steam separator model utilised is the CATHARE simple separator model with constant carry-under ratios.

d) *How are the turbine stop valve closing and steam bypass system modelled?*

TSV and BPV are modelled by a head-loss coefficient, which is adjusted to simulate the valve closing and opening.

e) *What were the difficulties encountered during the component design modelling?*

No particular difficulty was encountered for global modelling.

4. General

a) *Deviations from the updated final specifications?*

b) *User assumptions? Please provide the timestep(s) size or maximum and minimum values used for the simulation of Exercise 1.*

The maximum timestep value for the transient calculation is 10^{-4} s. A sensitivity study showed that results were not modified if the timestep was kept lower than 0.005 s.

c) *Specific features of the codes used?*

CATHARE is a best-estimate code for LWR transient analysis. The code is based on a six-equation, two-phase flow model with a set of closure laws assessed on a large number of experiments.

d) *Number of solutions submitted per participant and how they differ?*

One solution for Exercise 1.

e) *If your results are significantly different ($> 3\sigma$) than the measured or Exelon results, are there any explanations for these differences? Please explain each significant difference.*

S-RELAP5 (FANP, Germany)

1. Thermal-hydraulic model and nodalisation of the vessel and balance of the plant

a) What kind of nodalisation is used (1-D, 3-D and number of T-H channels or cells)?

See the nodalisation schema below (Figure B-2).

Figure B-2. FANP nodalisation diagram

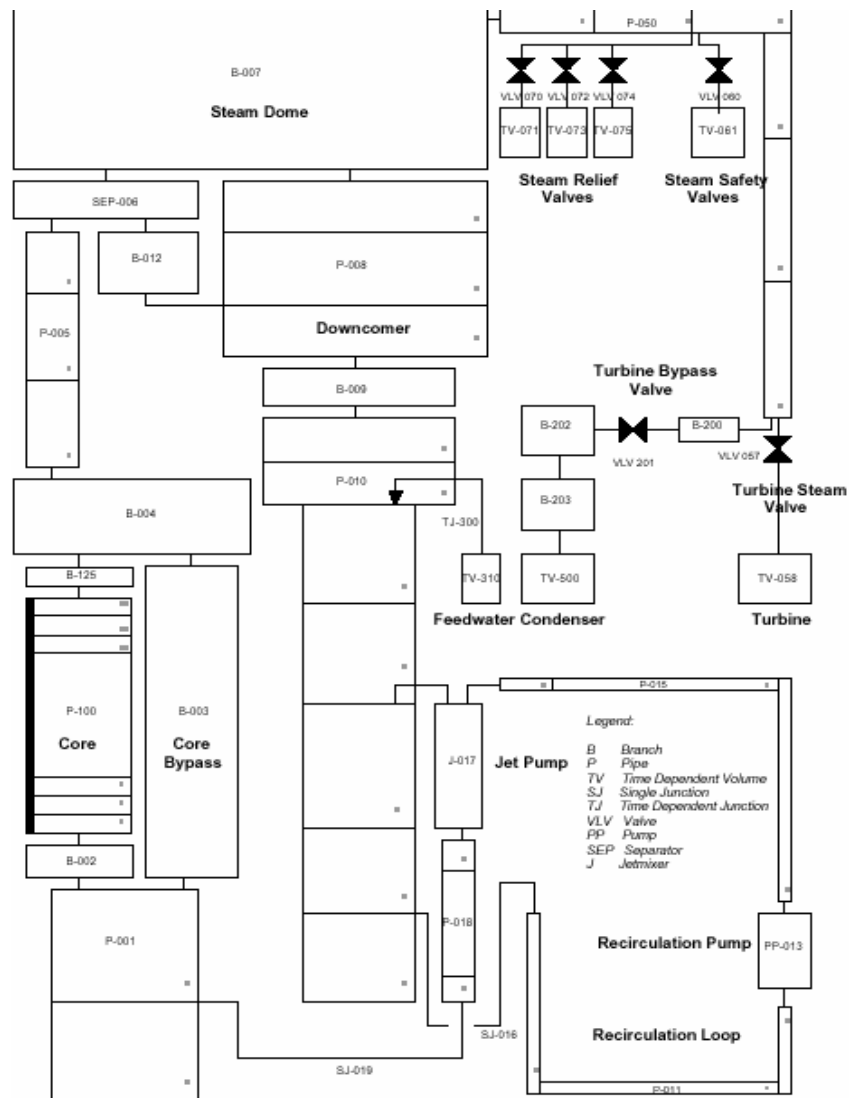

b) *How are the volumes, junctions and channels/T-H cells chosen? (If possible, please provide schematic.)*

Close to RETRAN nodalisation schema.

c) *Please provide in detail the nodalisation of the steam line.*

See the FANP nodalisation diagram (Figure B-2).

2. *Boundary conditions*

a) *Which core thermal-hydraulic initial and transient boundary conditions are used and how?*

Boundary conditions provided by the benchmark team.

b) *Which neutronic/power initial and transient boundary conditions are used and how?*

Boundary conditions provided by the benchmark team.

3. *Component design and modelling*

a) *How many core bypass channels are used in this exercise?*

One.

b) *How are the jet pumps modelled?*

S-RELAP5 standard component.

c) *How is the steam separator modelled?*

S-RELAP5 standard component.

d) *How are the turbine stop valve closing and steam bypass system modelled?*

Turbine stop valve – linear closure within 96 ms.

Steam bypass system – modelled in such a way that the steam outflow value of RETRAN (provided by the benchmark team) matched the final specifications.

e) *What were the difficulties encountered during the component design modelling?*

4. *General*

a) *Deviations from the updated final specifications?*

None.

b) User assumptions? Please provide the timestep(s) size or maximum and minimum values used for the simulation of Exercise 1.

Six milliseconds (6 ms).

c) Specific features of the codes used?

d) Number of solutions submitted per participant and how they differ?

e) If your results are significantly different ($> 3\sigma$) than the measured or Exelon results, are there any explanations for these differences? Please explain each significant difference.

ATHLET (GRS, Germany)

1. Thermal-hydraulic model and nodalisation of the vessel and balance of the plant

a) What kind of nodalisation is used (1-D, 3-D and number of T-H channels or cells)?

One-dimensional (1-D) nodalisation, two T-H channels in the core.

b) How are the volumes, junctions and channels/T-H cells chosen? (If possible, please provide schematic.)

See Figures B-3 and B-4 for the nodalisation schemas of the pressure vessel and steam line.

c) Please provide in detail the nodalisation of the steam line.

Figure B-3. GRS reactor pressure vessel nodalisation schema

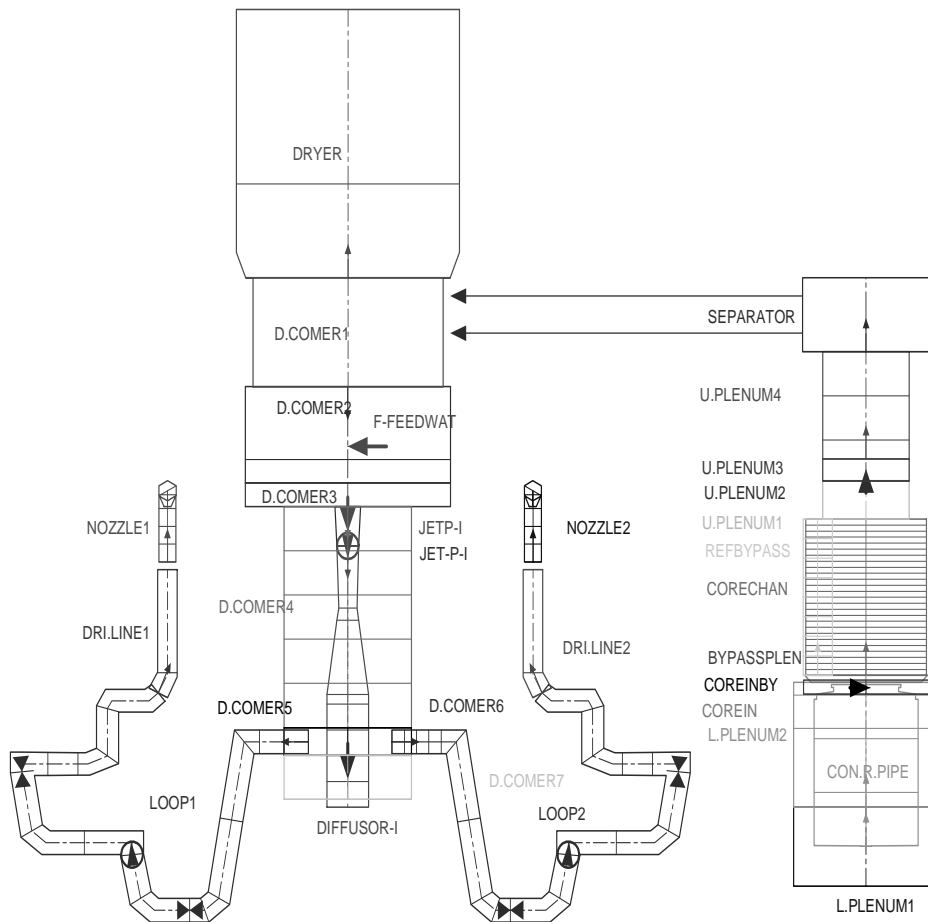
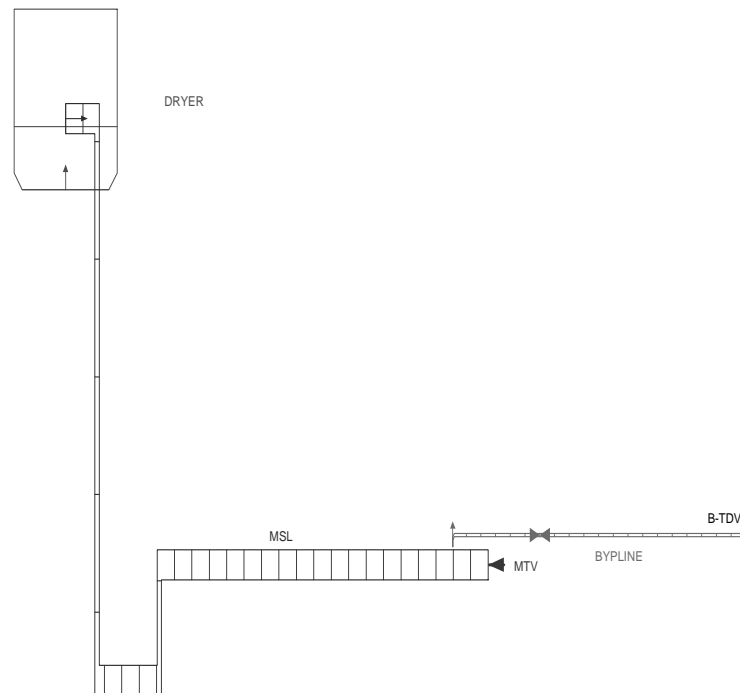

Figure B-4. GRS steam line nodalisation schema



2. Boundary conditions

a) Which core thermal-hydraulic initial and transient boundary conditions are used and how?

Mass flow rate at core inlet = 10 580.89 kg/s.

Bypass mass flow rate = 841.8 kg/s.

Pressure at core dome – as measured at steady state.

Core pressure losses adapted to 0.82 bar and mean void to 30.4%.

Core inlet enthalpy – as specified.

b) Which neutronic/power initial and transient boundary conditions are used and how?

Axial power distribution – as specified.

Power history – as specified.

3. Component design

a) How many core bypass channels are used in this exercise?

One bypass channel.

b) How are the jet pumps modelled?

The model consists of two symmetrical recirculation loops. The mass flow rate through the jet pumps and the pressure difference are adjusted to specifications (see nodalisation schema).

c) How is the steam separator modelled?

The steam separator is modelled by a corresponding module of ATHLET.

d) How are the turbine stop event and steam bypass flow simulated?

The turbine stop valve closing is modelled by a linear change of the flow area within the closure time. The steam bypass valve is opened by a linear change of the flow area within the opening time. It is assumed that critical flow conditions constantly exist and that in fully opened condition the mass flow rate is ~600 kg/s.

e) What were the difficulties encountered during the component design?

Great effort was made to approximate the pressure distribution within the reactor vessel corresponding to the given values from the plant.

4. General

a) Deviations from the updated final specifications?

No considerable deviations.

b) User assumptions? Please provide the timestep(s) size or maximum and minimum values used for the simulation of Exercise 1.

c) Specific features of the codes used?

Five-equation model of the thermal-hydraulics.

d) Number of solutions submitted per participant and how they differ?

Only one solution delivered.

f) If your results are significantly different ($> 3\sigma$) than the measured or Exelon results, are there any explanations for these differences? Please explain each significant difference.

DNB/3D (NETCORP, USA)

1. Thermal-hydraulic model and nodalisation of the vessel and balance of the plant

General model illustrated in Figure B-6.

a) What kind of nodalisation is used (1-D, 3-D and number of T-H channels or cells)?

One-dimensional (1-D) homogeneous equilibrium.

b) How are the volumes, junctions and channels/T-H cells chosen? (If possible, please provide schematic.)

There are six volumes in the reactor vessel and 24 vertically stacked volumes in the core that represent the core average fuel channel. See Figure B-5.

c) Please provide in detail the nodalisation of the steam line.

See Figure B-7. Note that there are seven piping volumes and each piping volume is subdivided (using mesh points for solving the conservation equations with the method of characteristics) into sub-volumes of ~10-15 feet in length.

2. Boundary conditions

a) Which core thermal-hydraulic initial and transient boundary conditions are used and how?

The thermal-hydraulic boundary conditions that were used are: 1) feedwater flow (see Table 5.3.3 of final specifications) and 2) steam bypass flow (from the BWR TT ftp site).

b) Which neutronic/power initial and transient boundary conditions are used and how?

The total core power boundary condition was used (file provided on the BWR TT ftp site).

3. Component design and modelling

a) How many core bypass channels are used in this exercise?

One – represents the core average bypass channel (see Figure B-5).

b) How are the jet pumps modelled?

The jet pump representation is shown in Figures B-8, B-9 and B-10.

c) How is the steam separator modelled?

The steam separator representation is shown in Figures B-8, B-9 and B-10.

d) *How are the turbine stop valve closing and steam bypass system modelled?*

The turbine stop valve position closing was assumed to close linearly with time; however, the non-linear area as a function of position was included in the model. The steam bypass flow was based on the boundary condition as noted in Figure B-10.

e) *What were the difficulties encountered during the component design modelling?*

No difficulties were encountered in the component modelling.

4. General

a) *Deviations from the updated final specifications.*

There were no known deviations from the final specifications.

b) *User assumptions. Please provide the timestep(s) size or maximum and minimum values used for the simulation of Exercise 1.*

The thermal-hydraulic timestep size was 0.01s for reactor vessel regions and 0.001 s for steam line regions.

c) *Specific features of the codes used?*

See the code description for DNB/3D in Appendix A.

d) *Number of solutions submitted per participant and how they differ?*

Only one solution was submitted.

e) *If your results are significantly different ($> 3\sigma$) than the measurement or Exelon results, are there any explanations for these differences? Please explain each significant difference.*

There are no known significant differences.

Figure B-5. NETCORP reactor vessel nodalisation

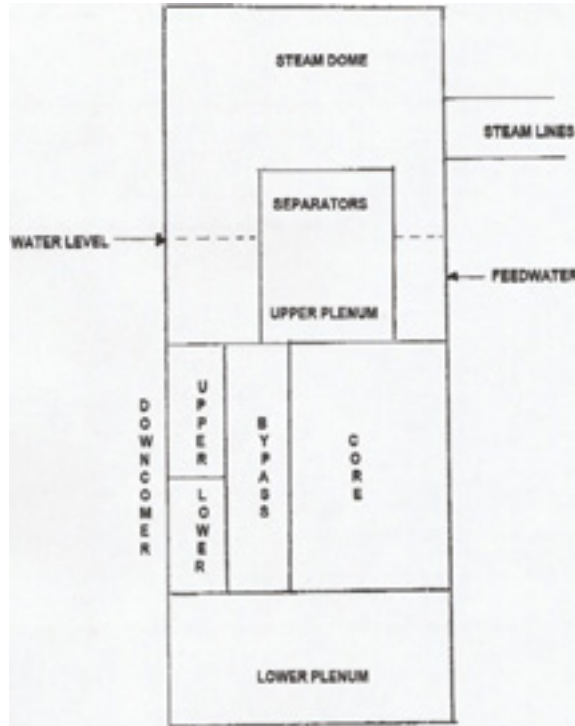

Figure B-6. NETCORP schematic of BWR NSSS representation

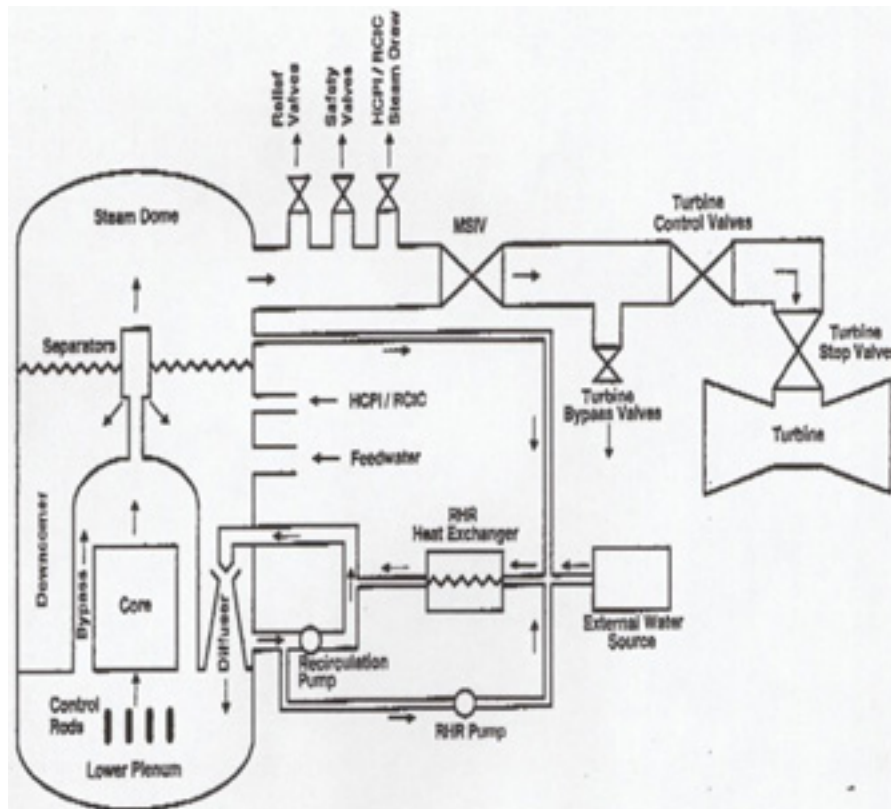

Figure B-7. NETCORP's method of characteristics of main system

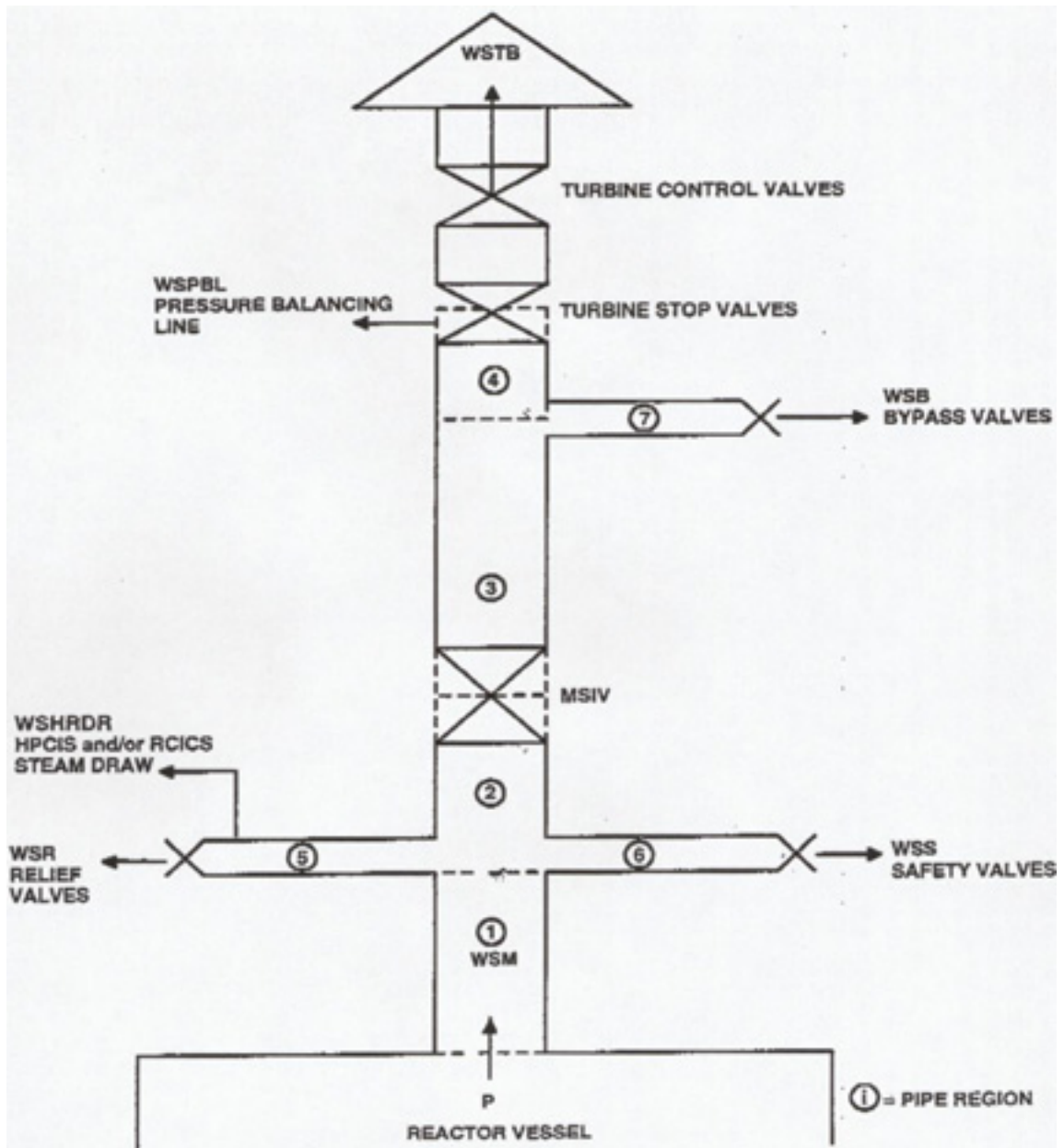

Figure B-8. NETCORP schematic of reactor vessel geometry for jet pumps

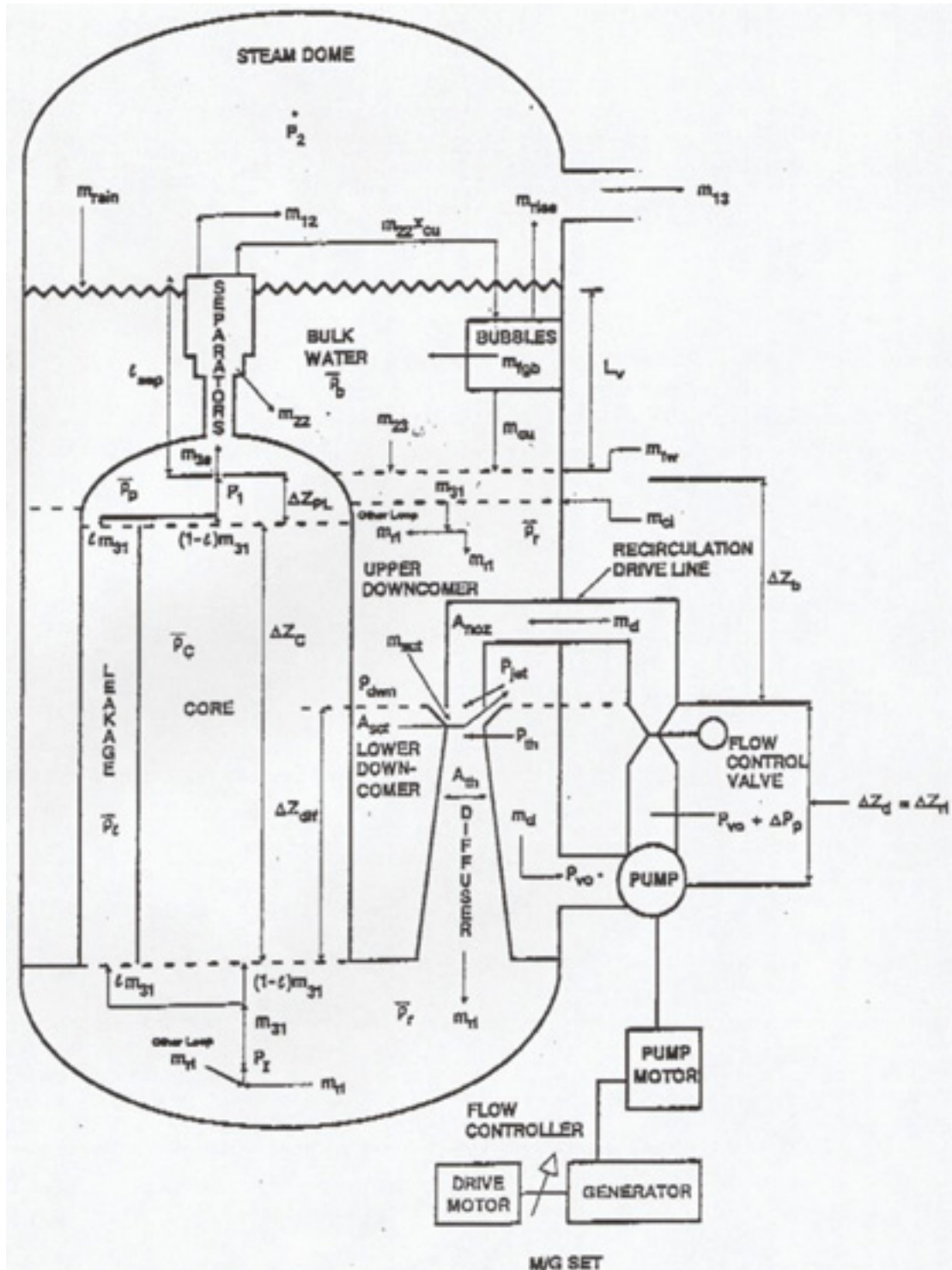

Figure B-9. NETCORP flow diagram within reactor vessel for jet pumps

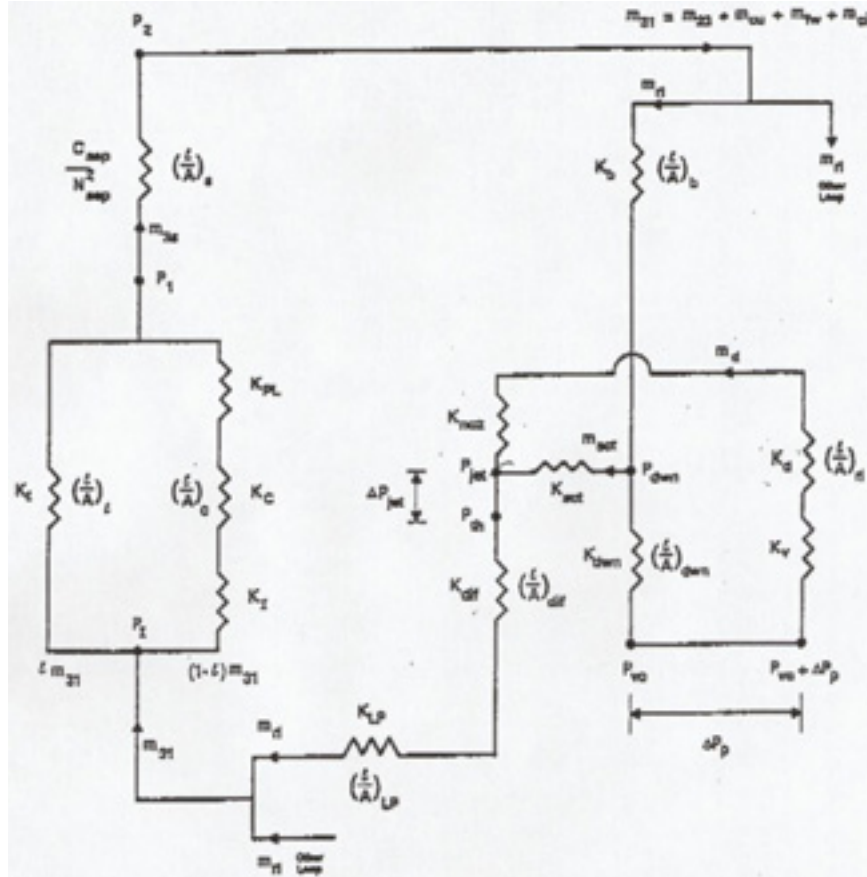

Figure B-10. NETCORP DNB/3D equations

• Nozzle Outlet to Diffuser Inlet

$$\Delta P_{jet} = P_{thi} - P_{jet}$$

$$= \frac{[(m_{di}^2 / A_{nozi}) + (m_{SCTi}^2 / A_{SCTi}) - (m_{RLi}^2 / A_{thi})]}{(144 g_c A_{thi} \rho_r)} \quad (1)$$

• Separator Inlet to Dome

$$\frac{[(\frac{l}{A})' (1 - \chi_{pi}) + (\frac{l}{A})_s \chi_{pi}] (\frac{dm_{3s}}{dt})}{g_c} = 144 (P_1 - P_2) - (\frac{g}{g_c}) (\rho_p l_{sep}) - (\frac{C_{sep} m_{3s} l_{sep}}{\rho_p N_{sep}^2}) \quad (2)$$

where,

χ_{pi} = the quality of the flow at the separator inlet

$(\frac{l}{A})'$ = a function of χ_{pi} as determined from a user specified table

$$(\frac{l}{A})_s = [(\frac{l}{A})_{sep}' - (\frac{l}{A})'(\chi_{pi})] \chi_{pi}$$

$$(\frac{l}{A})_{sep} = (\frac{l}{A})' \chi_{pi} = 0$$

TRAC-BF1 (NFI, Japan)

1. Thermal-hydraulic model and nodalisation of the vessel and balance of the plant

a) What kind of nodalisation is used (1-D, 3-D and number of T-H channels or cells)?

RPV is modelled with 10 levels for vertical direction and two rings for radial direction using the VESSEL component of TRAC-BF1. The T-H core is modelled with 33 channels using CHAN components. Every CHAN component has 26 nodes in total – 24 nodes for active fuel, two nodes for lower and upper tie plates.

b) How are the volumes, junctions and channels/T-H cells chosen? (If possible, please provide schematic.)

The nodalisation lines (in orange) of Figure B-11 indicate the nodalisation of RPV.

Top of level 1: Bottom of guide tube	Top of level 6: Top of shroud head
Top of level 2: Bottom of downcomer	Top of level 7: Bottom of separator
Top of level 3: Bottom of reactor core	Top of level 9: Top of dryer
Top of level 4: Top of jet pump	Top of level 10: Top of RPV
Top of level 5: Top of reactor core	

Figure B-11. NFI TRAC-BF1 nodalisation diagram

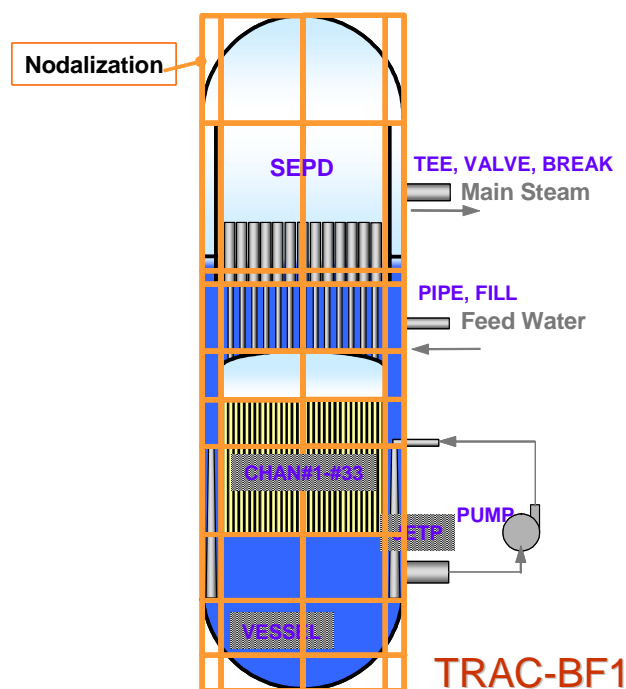

c) Please provide in detail the nodalisation of the steam line.

There are seven nodes between RPV and TSV, and 11 nodes between RPV and the condenser. All parameters such as diameters, lengths and volumes are based on the RETRAN skeleton deck of the BWR TT specifications [NEA/NSC/DOC(2001)1, Appendix A, Skeleton Input Deck].

Figure B-12. NFI TRAC-BF1 steam line nodalisation

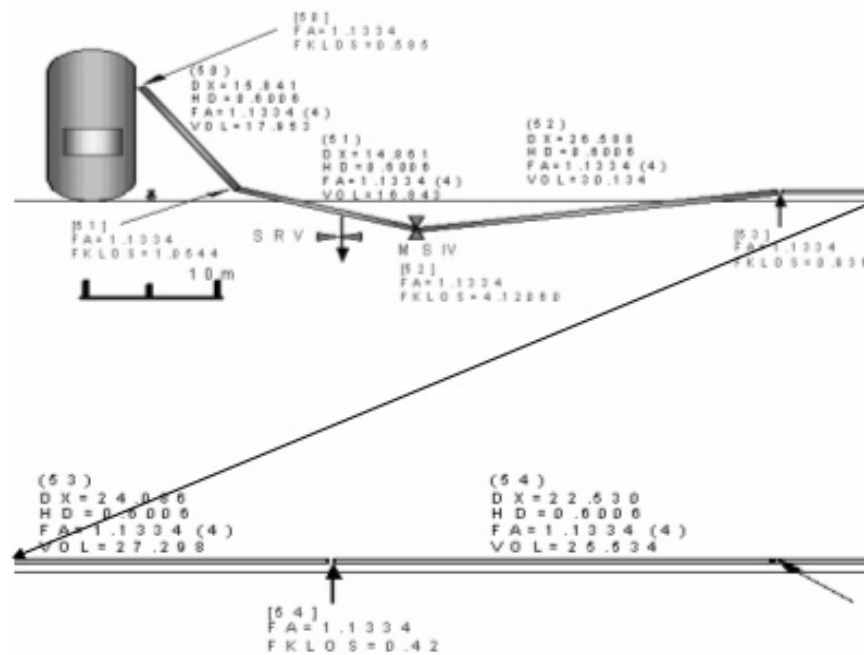

2. Boundary conditions

a) Which core thermal-hydraulic initial and transient boundary conditions are used and how?

Steady state condition is achieved using three element controls, namely, pressure control, feedwater control and recirculation control, which are in agreement with the initial condition indicated by the BWR TT specifications. Therefore, initial conditions of core exit pressure, water level and total jet pump flow are in good agreement with the specifications. As for core inlet flow and bypass flow, each flow rate and core inlet enthalpy are calculated by TRAC-BF1 simultaneously based on core power distribution, leak flow, two-phase friction pressure drop and pressure drop of SEO at the central and peripheral channels.

Transient boundary conditions such as pressure increase are caused by the closing of TSV and the opening of BPV, which cause pressure propagation to increase through the main steam line and the bypass line. As a result, core exit pressure changes but core total power is given as input data.

b) Which neutronic/power initial and transient boundary conditions are used and how?

Neutronic/power initial and transient boundary conditions given as BWR TT specifications are used (i.e. see file *nfpower_exercise1*).

3. *Component design and modelling*

a) *How many core bypass channels are used in this exercise?*

Core bypass channels are not used as CHAN but as VESSEL components. Levels 3 and 4 of VESSEL correspond to the bypass region. We neglect direct heating in core bypass region.

b) *How are the jet pumps modelled?*

The JETP component is used. The specification is the same as Table 3.1.2.2 and Figure 3.1.2.1 of the BWR TT specifications. The junction loss coefficients (jet pump nozzle, suction, etc.) are utilised using the TRAC-BF1 recommended value.

c) *How is the steam separator modelled?*

The SEPD component is used. The simple separator model in TRAC-BF1 is selected, so the carry-under ratio keeps constant during the transient.

d) *How are the turbine stop valve closing and steam bypass system modelled?*

The characteristics of Tables 5.2.1 and 5.2.2 of BWR TT benchmark specifications are used for TSV and BPV, respectively.

e) *What were the difficulties encountered during the component design modelling?*

As for Exercise 1, there is no outstanding difficulty for component design modelling.

4. *General*

a) *Deviations from the updated final specifications?*

b) *User assumptions? Please provide the timestep(s) size or maximum and minimum values used for the simulation of Exercise 1.*

The minimum and maximum timestep value of TRAC-BF1 is 3.0×10^{-5} s and 3.0×10^{-1} s, respectively. The actual timestep value is changing between them during the calculation.

c) *Specific features of the codes used?*

TRAC-BF1 is a best-estimate code for BWR transient or accident analysis. This code includes a full non-homogeneous, non-equilibrium, two-fluid thermal-hydraulic model of two-phase flow.

d) *Number of solutions submitted per participant and how they differ?*

It is our view that the difference between the participants is caused by two main reasons. One is the difference between codes and their models. The codes would be different in physical models versus thermal-hydraulic models. Another is the difference of nodalisation. The modelling of main steam lines/RPV or pressure loss profile along pipelines affects pressure propagation/increase.

e) *If your results are significantly different ($> 3\sigma$) than the measured or Exelon results, are there any explanations for these differences? Please explain each significant difference.*

TRAC-BF1 (NUPEC, Japan)

1. Thermal-hydraulic model and nodalisation of the vessel and balance of the plant

a) What kind of nodalisation is used (1-D, 3-D and number of T-H channels or cells)?

The reactor pressure vessel is modelled in 3-D cylindrical co-ordinates with two radial rings and 15 axial levels. Thermal-hydraulic channels were treated as three 1-D parallel channels.

b) How are the volumes, junctions and channels/T-H cells chosen? (If possible, please provide schematic.)

See Figure B-13.

c) Please provide in detail the nodalisation of the steam line.

See Figure B-13.

Figure B-13. NUPEC Peach Bottom 2 plant nodalisation

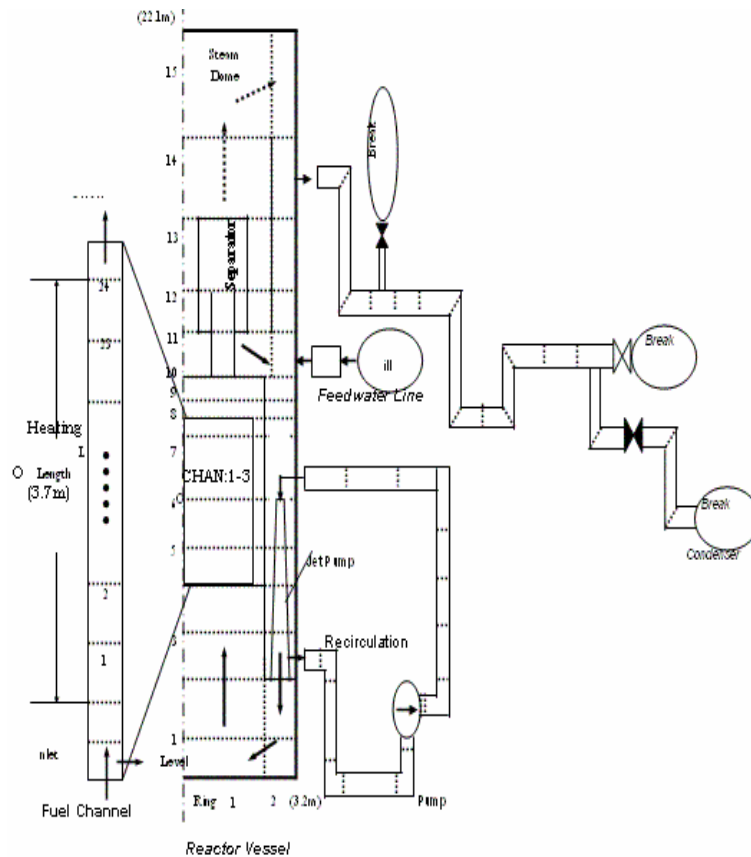

2. **Boundary conditions**

a) *Which core thermal-hydraulic initial and transient boundary conditions are used and how?*

Core flow rate and feedwater at initial were from the final specifications. Feedwater flow rate and temperature during the transient were also from the final specifications.

b) *Which neutronic/power initial and transient boundary conditions are used and how?*

Fission power was from the final specifications. Decay heat was taken in account.

3. **Component design and modelling**

a) *How many core bypass channels are used in this exercise?*

Core bypass region was simulated by one vessel region. The core bypass flow was simulated with a leak path model from the T-H channel to the vessel (core bypass) region.

b) *How are the jet pumps modelled?*

The jet pumps were modelled with the JETP component of TRAC-BF1, following Table 3.1.2.2 and Figure 3.1.2.1 in the final specifications.

c) *How is the steam separator modelled?*

The steam separators were modelled with SEPD component using a mechanistic model of TRAC-BF1. Code defaults were used.

d) *How are the turbine stop valve closing and steam bypass system modelled?*

The turbine stop valve and steam bypass valve were modelled with the VALVE component of TRAC-BF1. The valve movements were given as timetables.

e) *What were the difficulties encountered during the component design modelling?*

Simulation of inertia of the steam separators.

4. **General**

a) *Deviations from the updated final specifications?*

None.

b) *User assumptions? Please provide the timestep(s) size or maximum and minimum values used for the simulation of Exercise 1.*

Timesteps: 0.5-1.0 ms.

c) *Specific features of the codes used?*

None.

d) Number of solutions submitted per participant and how they differ?

One.

e) If your results are significantly different ($> 3\sigma$) than the measured or Exelon results, are there any explanations for these differences? Please explain each significant difference.

Our result was within 3σ of the measured result.

NUPEC used the TRAC-BF1 code in the first exercise. Peach Bottom 2 plant nodalisation is shown above in Figure B-13. The thermal-hydraulic channels were treated as three 1-D parallel channels. The reactor pressure vessel is modelled in 3-D cylindrical co-ordinates with two radial rings and 15 axial levels.

RETRAN-3D (PSI, Switzerland)

1. *Thermal-hydraulic model and nodalisation of the vessel and balance of the plant*

a) *What kind of nodalisation is used (1-D, 3-D and number of T-H channels or cells)?*

A 1-D nodalisation with 53 volumes and 63 junctions is used. The core region between the lower plenum and the upper plenum is represented by a core inlet volume, a core exit volume, a core bypass volume and a T-H channel representing the core, which consists of 24 axially stacked volumes with pre-defined power.

b) *How are the volumes, junctions and channels/T-H cells chosen? (If possible, please provide schematic.)*

For the modelling of the transient, we used the code RETRAN-3D. Although the reference solution for the benchmark was developed using RETRAN-02 [by Andy Olson (Exelon/USA)] in order to fit the results as much as possible, we decided to develop a PSI RETRAN-3D model. The aim was to increase our team's learning curve. Our RETRAN-3D input model for the phase 1 calculation was developed from an early RETRAN-02 model for Turbine Trip 1 [Horniyk and Naser, 1979]. From this model, we used the nodalisation for the reactor vessel (including the steam separator and downcomer region), the recirculation loop and the steam lines. As preparation for the inclusion of the 3-D core in the later benchmark phases, the reactor core region was renodalised (including the accompanying heat structures) to include 24 axial control volumes, in combination with a core exit volume and core inlet volume connected to the core bypass volume. From the benchmark specifications, we included the time-dependence and axial profile of the pre-defined power, together with the feedwater flow, the turbine inlet flow rate and the turbine bypass area of Turbine Trip 2. In addition, the value of enthalpy in the lower plenum, steam dome pressure and flow rates at $t = 0$ were used.

We investigated the sensitivity of our model with respect to non-equilibrium effects in the steam separator region and to pressure losses in the turbine bypass line. The improvements with respect to the non-equilibrium effects were included in the 3-D model, since they influence the magnitude and timing of the power maximum. Improvements relating to pressure losses in the turbine bypass line (effective only after $t = 2$ s) were not included.

Figure B-14. PSI nodalisation of the reactor vessel

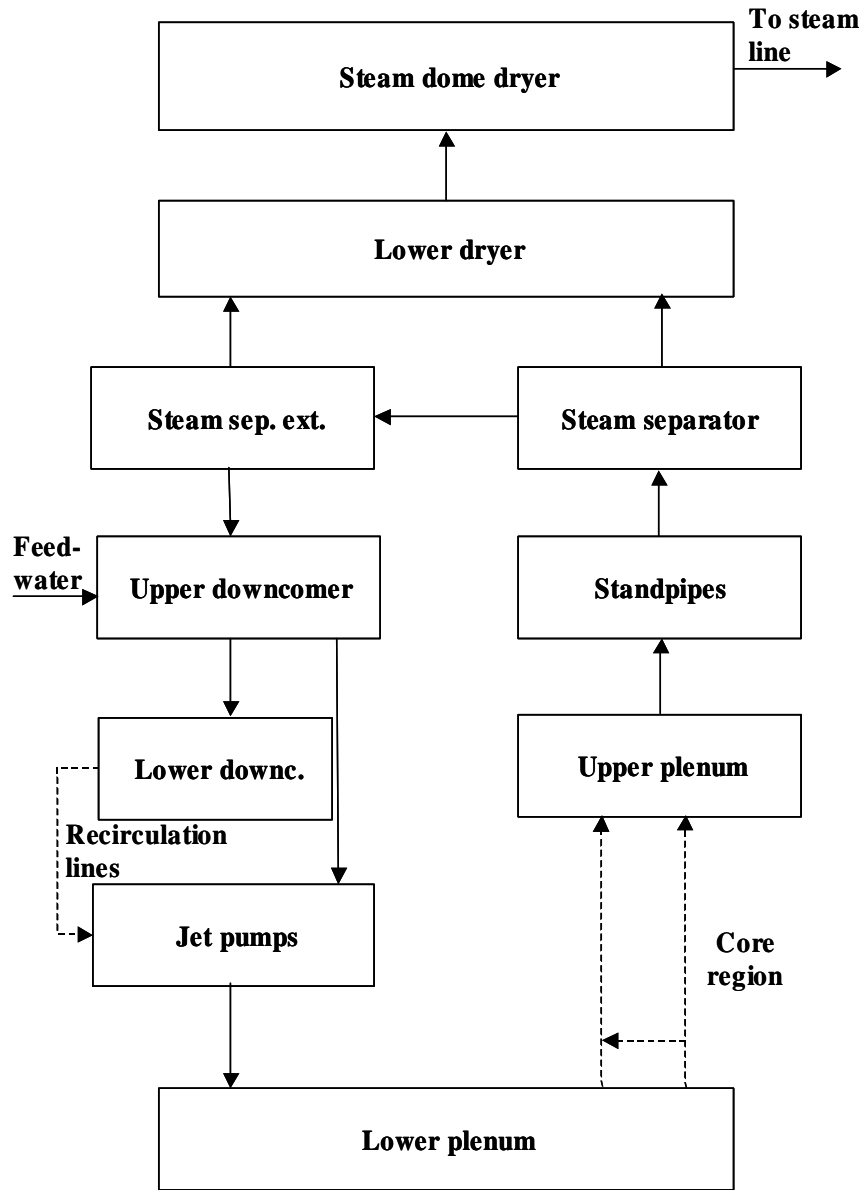
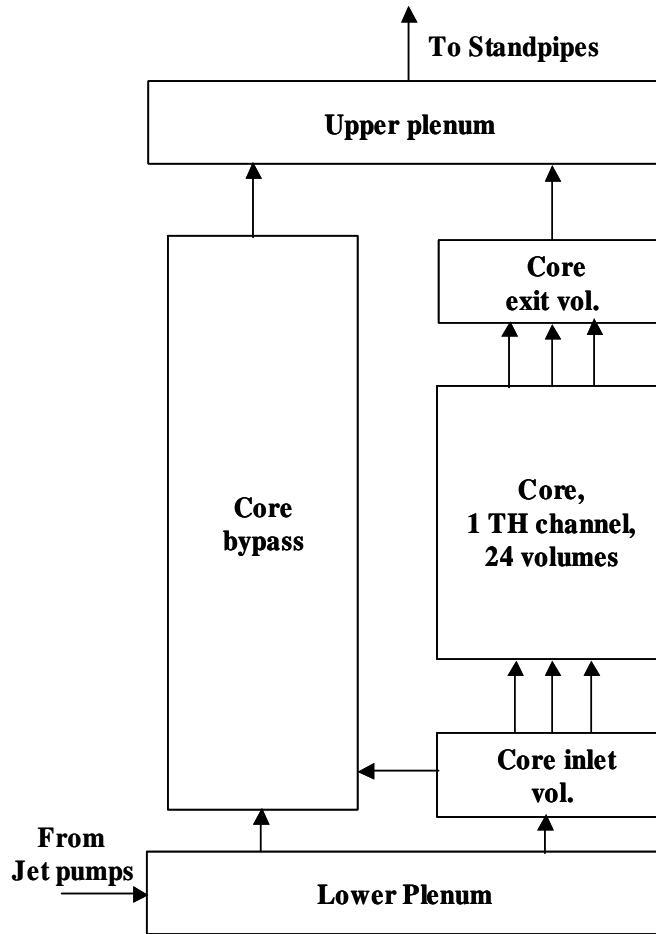

Figure B-15. PSI nodalisation of the channels



Nodalisation of the core region: 1-D representation of the core, core inlet volume + core exit volume + bypass volume + 1-D representation of the core consisting of 24 axially stacked volumes levels, which are connected to “heating elements” with pre-defined power.

c) Please provide in detail the nodalisation of the steam line.

Figure B-16 gives the detailed nodalisation of the steam line.

2. Boundary conditions

a) Which core thermal-hydraulic initial and transient boundary conditions are used and how?

At time zero, the liquid enthalpy in the lower plenum and the system pressure in the steam dome are defined. Also specified at time zero are the total flow rate through the core, the flow rate from the lower plenum to the core bypass and the flow rate from the core inlet volume to the core bypass volume, which define all flow rates in the core region and give relevant loss coefficients at the junctions. The loss coefficients at the junctions used at time zero are then also applied by the RETRAN-3D code for all other times.

b) Which neutronic/power initial and transient boundary conditions are used and how?

Twenty-four (24) axially stacked volumes are used in the core with pre-defined power. The axial power shape in the core is time-independent and the time-averaged power of the core is defined as described in the final specifications.

Figure B-16. PSI nodalisation of the steam line

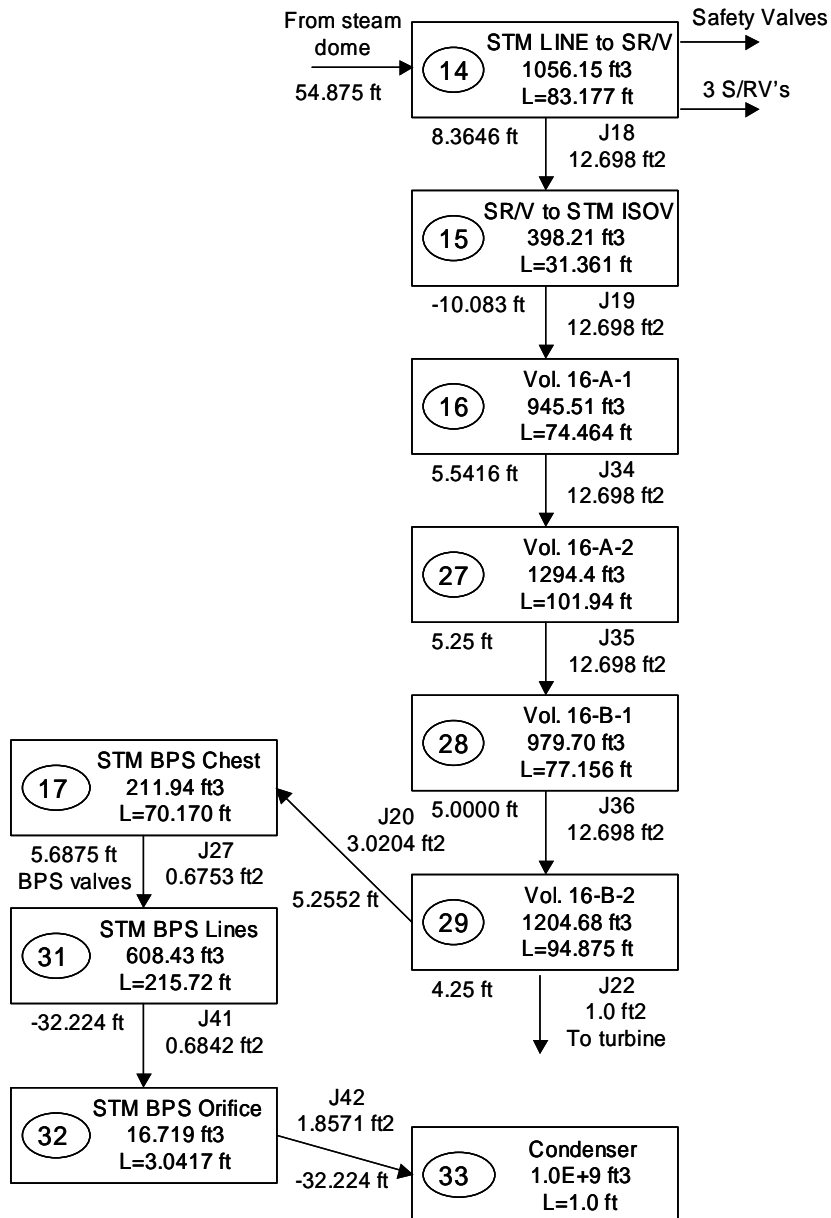

3. Component design and modelling

a) *How many core bypass channels are used in this exercise?*

One core bypass channel.

b) *How are the jet pumps modelled?*

The jet pumps are modelled using a RETRAN-3D pump model.

c) *How is the steam separator modelled?*

In order to determine the distribution of the steam flow, it is important to follow the flow of steam through the separators into the steam dome. In the reactor, two-phase flow from the core region passes through the standpipes and then enters the steam separators. In each separator, the steam-water mixture passes turning vanes, which impart a spin to establish a vortex and separates the water from the steam. The denser liquid is thrown radially outward by centrifugal force forming a continuous film on the inside wall of the inner pipe. The separator water exits from under the separator cap and flows out between the standpipes, draining into the downcomer. Steam with a quality of at least 90% exits from the top of the separator and rises to the dryers. The dryers force the wet steam to be directed horizontally through the dryer panels. The steam flow makes a series of rapid changes in direction while traversing the panels. During these direction changes, the heavier drops of entrained moisture are forced to the outer walls where moisture collection hooks catch and drain the liquid to collection troughs, then through tubes into the vessel downcomer so that the steam dryer assembly increases the quality of the steam to more than 99.9%. This dry steam flows into the steam dome and the steam lines.

This behaviour is approximated in the RETRAN-3D model by control volumes (CV 1-5 in Figure B-17). Two-phase flow from the core region flows into the steam separator volume (CV 1). In this volume, a liquid level is defined, below which a two-phase flow is established. Above the liquid level there is only steam flow. In this volume (CV 1), the RETRAN-3D bubble rise model option is used. The steam flows upwards to the lower dryer volume (CV 2) and continues to the steam dome volume (CV 3) and into the steam line.

Two-phase flow, which consists of water with some vapour carry-under, flows from the steam separator volume to the steam separator external volume (CV 4). The junction between these two control volumes is below the liquid level in CV 1. In the steam separator external (CV 4), a liquid level develops with a steam phase above the liquid level and a two-phase region below the liquid level. The RETRAN-3D bubble rise model is again used to describe this phenomenon. At $t = 0$ there is a very small steam flow from the steam separator external to the lower dryer volume (CV 2), while the main flow is water down into the upper downcomer (CV 5). The feedwater also flows into the upper downcomer volume. From the upper downcomer volume, water flows to the lower downcomer and jet pumps, and from there back into the core.

Since the RETRAN-3D code option used in analysis is that of the four-equation model (i.e. full thermal equilibrium), the volume of water in steam separator (CV 1) and steam separator external (CV 4) two-phase control volumes is in equilibrium with the steam. And, this strongly influences the pressure increase per unit of steam generated in the core. As a result, a renodalisation of the separator/downcomer region was performed in a sensitivity study, which gave a pressure increase equal to the measured one at ~ 1 s. In order to achieve this, the volumes of the steam separator and the steam separator external control volumes were reduced in the sensitivity test, while the volume of the upper downcomer control volume was increased to preserve the total water volume.

Figure B-17. Nodalisation of the steam separator region

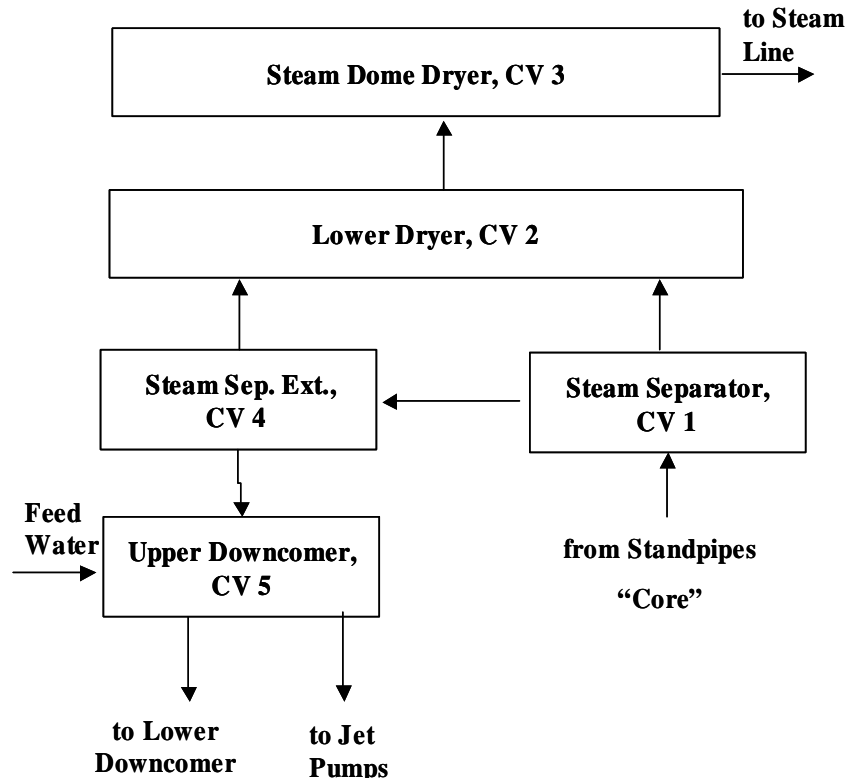

The main effect of renodalisation is a reduction in energy transfer from steam to liquid, which is due to the volume being smaller where thermal equilibrium is established. Thus, there is less condensation of the vapour as the pressure increases. To obtain the measured pressure increase, it was necessary to approximately halve the volume of the steam separator and the steam separator external control volumes.

Another RETRAN-3D code option that can be used to obtain a reduced energy transfer between liquid and vapour is the “two-region non-equilibrium model”. (Note that this model was used in conjunction with the RETRAN-3D bubble rise model to obtain the submitted results.) This model divides the fluid in the control volume at the liquid level interface into two regions, where each region is in internal thermal equilibrium but the two regions are not necessarily in equilibrium with each other. The liquid region below the interface and the vapour region above the interface have the same pressure, but in general have different temperatures (i.e. in the vapour region we may have superheated steam). The application of this model (in the steam separator volume and the steam separator external volume, CVs 1 and 4 in Figure B-17) also produced an increased pressure at ~1 s. A sensitivity study showed that the effect in the steam separator volume is negligible and the increased pressure at 1 s comes mostly from the steam separator external volume. The reason for this phenomenon is that after 0.3 s in the steam separator external volume, the pressure increase leads to an increase in the steam temperature in the vapour region. However, due to the non-equilibrium model, the energy transfer between the vapour region and the liquid region is reduced, maintaining the superheated steam in the vapour and dryer regions. In the steam separator region, there is a transfer of vapour from the liquid region at the level interface because of rising bubbles through the liquid region. Related to this phenomenon, the reduction of energy transfer across the interface due to the non-equilibrium model generates only a small effect.

d) *How are the turbine stop valve closing and steam bypass system modelled?*

The turbine stop valve closing is described by a negative fill junction model, which is combined with a valve where area versus time is specified. This defines the flow rate to the turbine.

The steam bypass system is modelled using four RETRAN-3D control volumes. The steam bypass chest volume is connected via the bypass valves to the steam bypass lines volume, which is connected to the steam bypass orifice volume that is in turn connected to the condenser. In the turbine bypass valve between the steam bypass chest volume and the steam bypass lines volume, area versus time is defined (approximately) to get the specified flow through the turbine bypass. Choked flow through the bypass valve is assumed.

e) *What were the difficulties encountered during the component design modelling?*

4. **General**

a) *Deviations from the updated final specifications?*

Since we decided that there would be no point just copying the reference RETRAN-02 model, our PSI RETRAN-3D model must have some differences in the final specifications [see also response to question 1b)]. For instance, the nodalisation of steam line, reactor vessel and steam separator region is based on the original model from Hornyik and Naser (1979). This means, for example, that the steam separator volume is connected to the steam separator external volume. That is to say that the two RETRAN-3D volumes with a liquid level are connected, which is not the case in the Olson model.

b) *User assumptions? Please provide the timestep(s) size or maximum and minimum values used for the simulation of Exercise 1.*

The minimum timestep size between 0-1.2 s is 0.001 s and 0.006 s after 1.2 s. However, a sensitivity study showed that the effect of choosing an overall minimum timestep of 0.006 s would have only a negligible effect on the results.

c) *Specific features of the codes used?*

As described above, the four-equation model was used for the two-phase flow calculation, together with an algebraic (Zolotar-Lellouche) slip correlation. The bubble rise model was used in the steam separator and steam separator external volumes to describe the development of a liquid level. The two-region non-equilibrium model was also used in the steam separator and steam separator external volumes to account for the relatively slow exchange of energy across the liquid level.

d) *Number of solutions submitted per participant and how they differ?*

One solution from PSI.

e) *If your results are significantly different ($> 3\sigma$) than the measured or Exelon results, are there any explanations for these differences? Please explain each significant difference.*

TRAC-BF1 (PSU, USA)

1. Thermal-hydraulic model and nodalisation of the vessel and balance of the plant

a) What kind of nodalisation is used (1-D, 3-D and number of T-H channels or cells)?

Three-dimensional (3-D) nodalisation for VESSEL, 1-D nodalisation for other components.

b) How are the volumes, junctions and channels/T-H cells chosen? (If possible, please provide schematic.)

See the PSU TRAC-BF1 nodalisation figure that follows (Figure B-18).

c) Please provide in detail the nodalisation of the steam line.

Straight forward nodalisation is used for steam line as shown as in Figure B-18 below.

Figure B-18. PSU TRAC-BF1 nodalisation

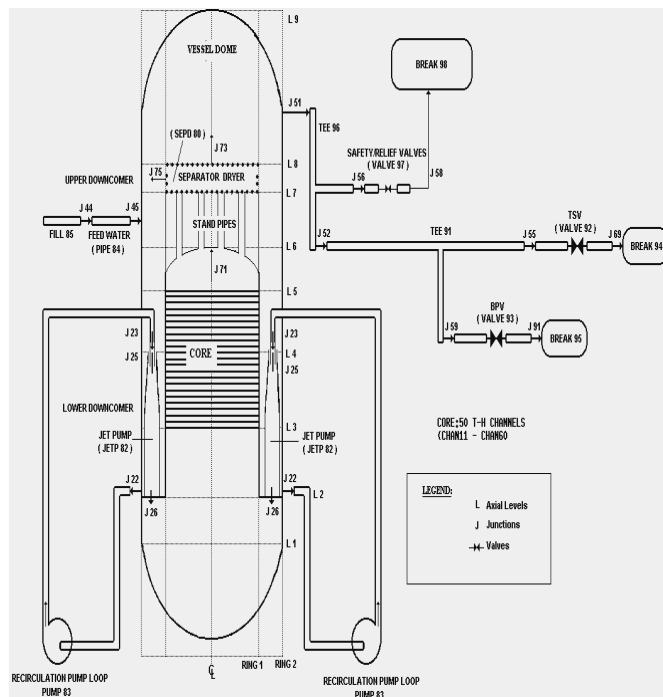

2. Boundary conditions

a) Which core thermal-hydraulic initial and transient boundary conditions are used and how?

Same as the boundary conditions in specifications.

b) *Which neutronic/power initial and transient boundary conditions are used and how?*

Power lookup table from specifications is used.

3. ***Component design and modelling***

a) *How many core bypass channels are used in this exercise?*

No bypass channel is used. Core bypass flow is simulated by leak paths from first cell of channels to related elevation of the vessel.

b) *How are the jet pumps modelled?*

Standard jet pump option of TRAC-B is used. See Figure B-18.

c) *How is the steam separator modelled?*

Simple separator is used.

d) *How are the turbine stop valve closing and steam bypass system modelled?*

Same as specifications.

e) *What were the difficulties encountered during the component design modelling?*

No difficulties were encountered.

4. ***General***

a) *Deviations from the updated final specifications?*

b) *User assumptions? Please provide the timestep(s) size or maximum and minimum values used for the simulation of Exercise 1.*

The convergence criterion is 0.0001 and courant number is 0.999. The timestep size is 6 ms. Some loss coefficients are assumed.

c) *Specific features of the codes used?*

See the TRAC-BF1 code description in Appendix A.

d) *Number of solutions submitted per participant and how they differ?*

One solution is provided.

e) *If your results are significantly different ($> 3\sigma$) than the measured or Exelon results, are there any explanations for these differences? Please explain each significant difference.*

The results agree well with the provided reference results.

TRAC-M (PSU/NRC, USA)

1. *Thermal-hydraulic model and nodalisation of the vessel and balance of the plant*

a) *What kind of nodalisation is used (1-D, 3-D and number of T-H channels or cells)?*

Three-dimensional (3-D) nodalisation for VESSEL, 1-D nodalisation for other components.

b) *How are the volumes, junctions and channels/T-H cells chosen? (If possible, please provide schematic.)*

See Figure B-19.

c) *Please provide in detail the nodalisation of the steam line.*

Straight forward nodalisation is used for steam line as shown as in Figure B-19.

2. *Boundary conditions*

a) *Which core thermal-hydraulic initial and transient boundary conditions are used and how?*

Same as the boundary conditions in specifications.

b) *Which neutronic/power initial and transient boundary conditions are used and how?*

Power lookup table from specifications is used.

3. *Component design and modelling*

a) *How many core bypass channels are used in this exercise?*

No bypass channel is used.

b) *How are the jet pumps modelled?*

Standard jet pump option of TRAC-M is used. See Figures B-19 and B-20.

c) *How is the steam separator modelled?*

Three-stage mechanistic separators are used.

d) *How were the turbine stop valve closing and steam bypass system modelled?*

They are the same as specifications.

e) What were the difficulties encountered during the component design modelling?

No difficulties were encountered.

Figure B-19. PSU/NRC TRAC-M nodalisation

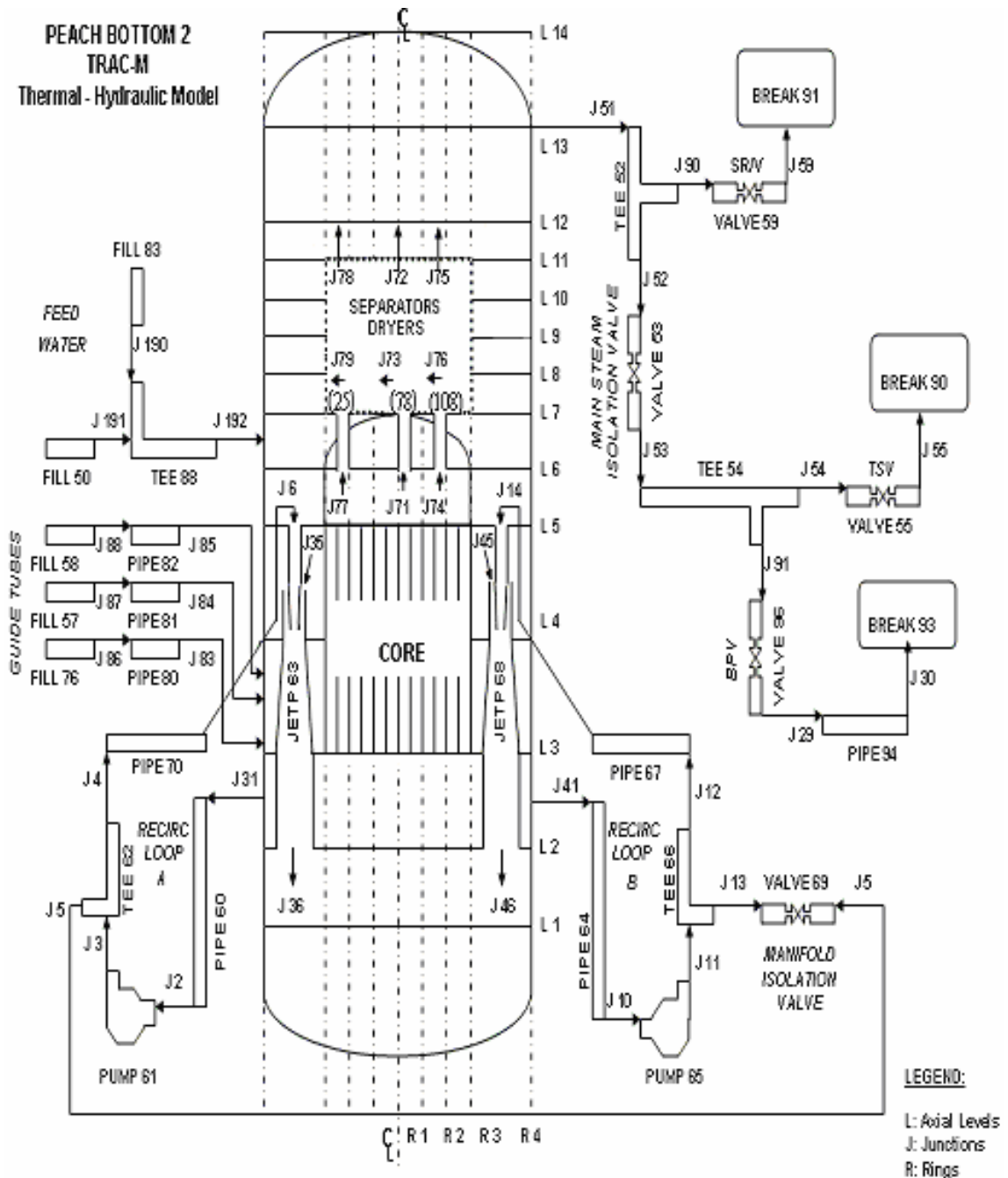

Figure B-20. PSU/NRC TRAC-M jet pump nodalisation

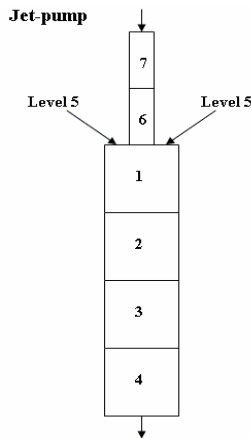
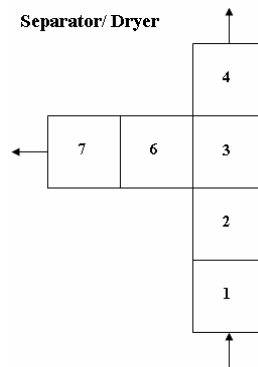

Figure B-21. PSU/NRC TRAC-M separator nodalisation



4. General

a) *Deviations from the updated final specifications?*

b) *User assumptions? Please provide the timestep(s) size or maximum and minimum values used for the simulation of Exercise 1.*

The convergence criterion is 0.0001 and courant number is 0.999. The timestep size is 6 ms. Some loss coefficients are assumed.

c) *Specific features of the codes used?*

See the TRAC-M code description in Appendix A.

d) *Number of solutions submitted per participant and how they differ?*

One solution is provided.

e) *If your results are significantly different ($> 3\sigma$) than the measured or Exelon results, are there any explanations for these differences? Please explain each significant difference.*

Generally, the results do not differ from the reference results (especially for first 1.5 s).

TRAC-BF1 (TEPSYS, Japan)

1. Thermal-hydraulic model and nodalisation of the vessel and balance of the plant

a) What kind of nodalisation is used (1-D, 3-D and number of T-H channels or cells)?

VESSEL 3-D, others 1-D, core T-H based on specifications.

b) How are the volumes, junctions and channels/T-H cells chosen? (If possible, please provide schematic.)

See the TEPSYS TRAC-BF1 plant model that follows (Figure B-22).

c) Please provide in detail the nodalisation of the steam line.

This nodalisation is common for most transient cases.

Figure B-22. TEPSYS TRAC-BF1 plant model

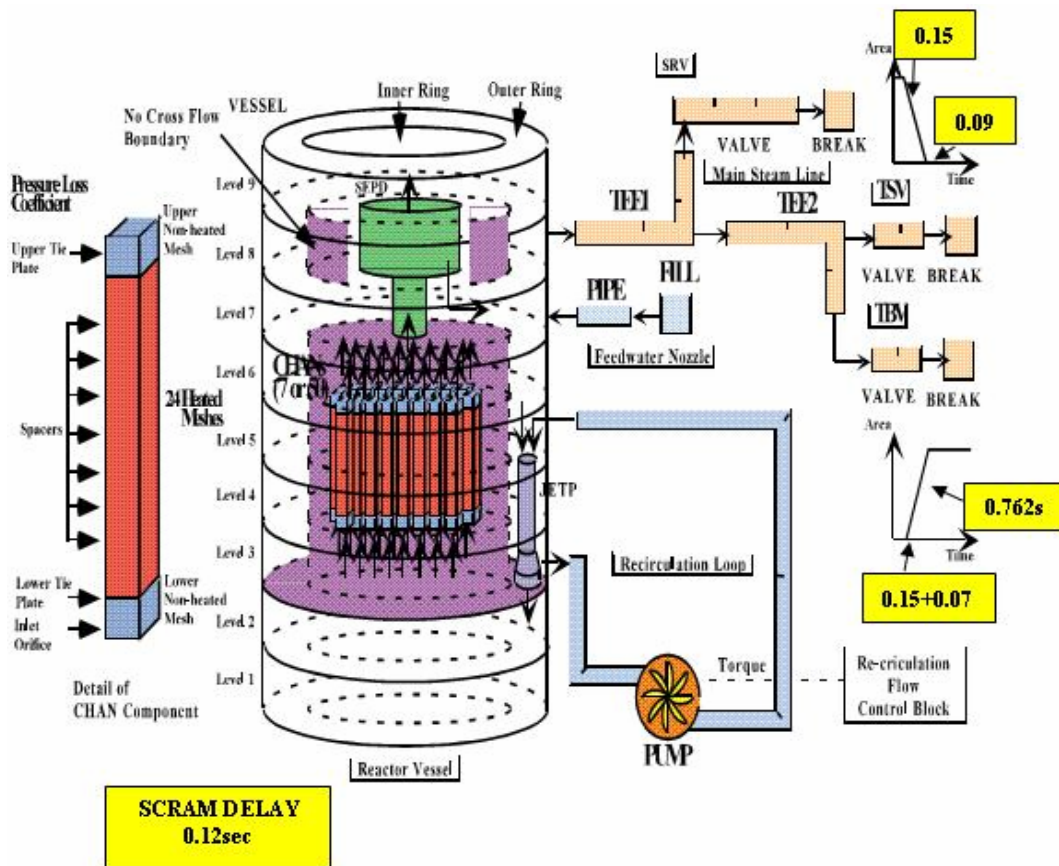

2. **Boundary conditions**

a) *Which core thermal-hydraulic initial and transient boundary conditions are used and how?*

Based on specifications.

b) *Which neutronic/power initial and transient boundary conditions are used and how?*

Based on specifications.

3. **Component design and modelling**

a) *How many core bypass channels are used in this exercise?*

Two.

b) *How are the jet pumps modelled?*

Single JETP model based on specifications and other aspects based on ordinary practice.

c) *How is the steam separator modelled?*

Single SEPD model based on specifications, other aspects on ordinary practice (simple separator).

d) *How are the turbine stop valve closing and steam bypass system modelled?*

Strictly based on specifications. Valve area was derived based on semi-empirical correlation.

e) *What were the difficulties encountered during the component design modelling?*

4. **General**

a) *Deviations from the updated final specifications?*

b) *User assumptions? Please provide the timestep(s) size or maximum and minimum values used for the simulation of Exercise 1.*

Delta-t was controlled automatically. The courant number was specified as unity.

c) *Specific features of the codes used?*

TRAC-BF1.

d) *Number of solutions submitted per participant and how they differ?*

It appears that we submitted only one solution as the reference condition. Other results, if any, must be regarded as done within the scope of the parametric study.

e) *If your results are significantly different ($> 3\sigma$) than the measured or Exelon results, are there any explanations for these differences? Please explain each significant difference.*

RELAP5 (UPISA, Italy)

1. Thermal-hydraulic model and nodalisation of the vessel and balance of the plant

a) What kind of nodalisation is used (1-D, 3-D and number of T-H channels or cells)?

One-dimensional (1-D) for the plant loop and 33 heated core channels, and a total of 1 230 volumes and 1 267 junctions.

b) How are the volumes, junctions and channels/T-H cells chosen? (If possible, please provide schematic.)

See Figure B-23 for a schema of the adopted nodalisation.

c) Please provide in detail the nodalisation of the steam line.

Table B-1. UPISA steam line and bypass system geometrical data

Item	Length (m)	Flow area (m ²)	Equivalent diameter (m)
Steam line 1	18.0	1.133	0.6
Steam line 2	4.68	1.133	0.6
Steam line 3	31.5	1.133	0.6
Steam line 4	4.36	1.133	0.6
Steam line 5	46.4	1.133	0.6
Steam line 6	0.22	1.133	0.6
Steam line 7	29.1	1.133	0.6
Steam bypass 8	6.9	0.2767	0.403
Steam bypass valve	–	0.0613	–
Steam bypass 9	51.7	0.2650	0.194

Figure B-23. UPISA RELAP5 model

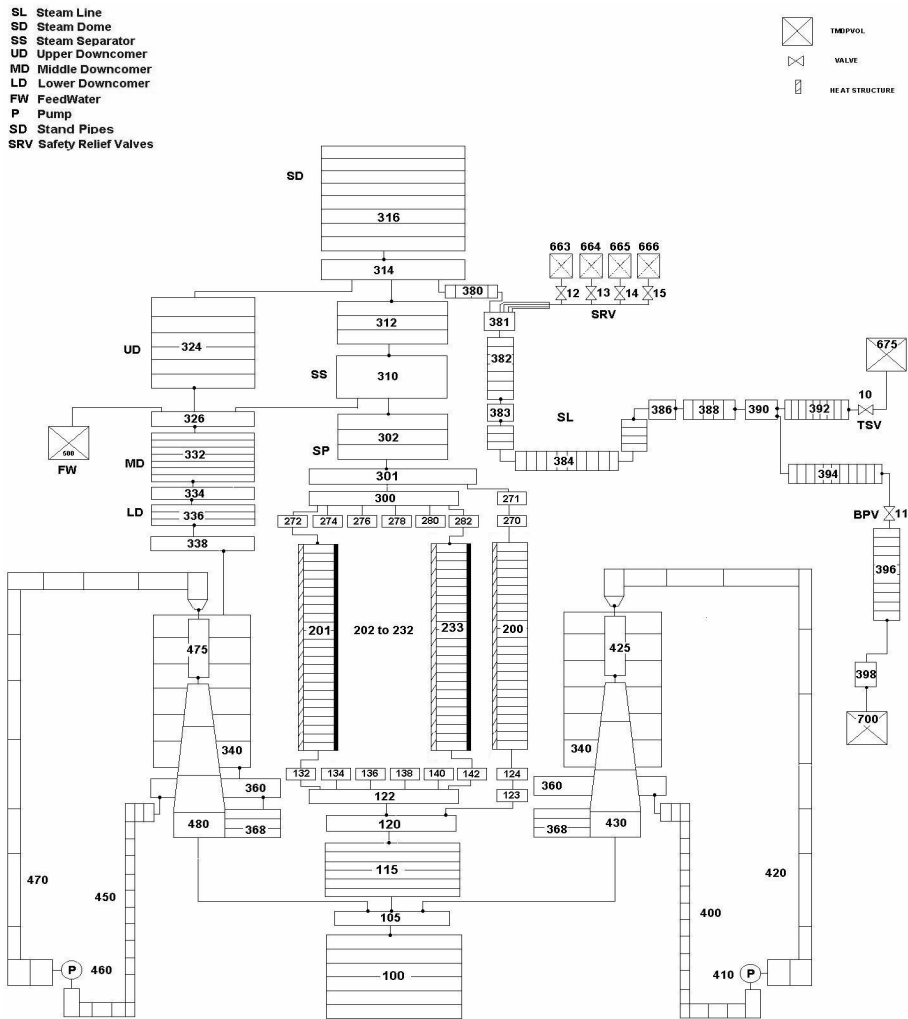
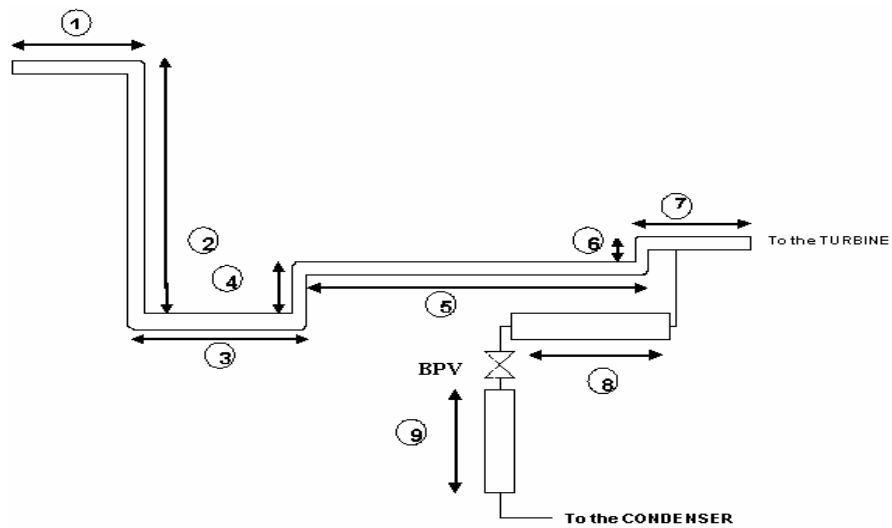

Figure B-24. UPISA steam line simplified schema



2. *Boundary conditions*

a) *Which core thermal-hydraulic initial and transient boundary conditions are used and how?*

No boundary conditions are specified in the core zone.

b) *Which neutronic/power initial and transient boundary conditions are used and how?*

Table B-2. UPISA decay constant and fractions of delayed neutrons

Group	Decay constant (s⁻¹)	Relative fraction of delayed neutrons in %
1	0.012813	0.0167
2	0.031536	0.1134
3	0.124703	0.1022
4	0.328273	0.2152
5	1.405280	0.0837
6	3.844728	0.0214

Total fraction of delayed neutrons equalled 0.5526%.

Decay heat using ANS-79 standard fission product data.

Transient reactivity table as specified in the BWR TT benchmark specification CD-ROM.

3. *Component design and modelling*

a) *How many core bypass channels are used in this exercise?*

One.

b) *How are the jet pumps modelled?*

The same as in the BWR TT benchmark specifications.

c) *How is the steam separator modelled?*

The default option of the RELAP5 separator.

d) *How are the turbine stop valve closing and steam bypass system modelled?*

Linear TSV closure.

The steam bypass system model is shown in Figure B-24 where the condenser is a big volume with thermal-hydraulic conditions of pressure equal to 17.5 MPa and equilibrium steam quality equal to 0.99

e) *What were the difficulties encountered during the component design modelling?*

To get the right individual channels steady state mass flow rate for the orifices at core inlet.

4. General

a) *Deviations from the updated final specifications?*

b) *User assumptions? Please provide the timestep(s) size or maximum and minimum values used for the simulation of Exercise 1.*

Minimum DT = $1.0 \text{ e} - 6 \text{ s}$

Maximum DT = $1.0 \text{ e} - 3 \text{ s}$

c) *Specific features of the codes used?*

The RELAP5/MOD3 code is based on a six-equation non-homogeneous and non-equilibrium model for the two-phase system. The solutions are obtained through fast resolution of a partially implicit numerical scheme.

d) *Number of solutions submitted per participant and how they differ?*

Two solutions, the main differences between them are outlined in the table below.

	Number of heated channels	Core pressure drop MPa	Inlet enthalpy
First solution	1	0.0670	1 194.0
Second solution	33	0.1025	1 208.5

e) *If your results are significantly different ($> 3\sigma$) than the measured or Exelon results, are there any explanations for these differences? Please explain each significant difference.*

TRAC-BF1-VALKIN (UPV, Spain)

1. Thermal-hydraulic model and nodalisation of the vessel and balance of the plant

a) What kind of nodalisation is used (1-D, 3-D and number of T-H channels or cells)?

The nodalisation used is 3-D and we have used 33 T-H channels.

b) How are the volumes, junctions and channels/T-H cells chosen? (If possible, please provide schematic.)

Figure B-25. UPV thermal-hydraulic nodalisation

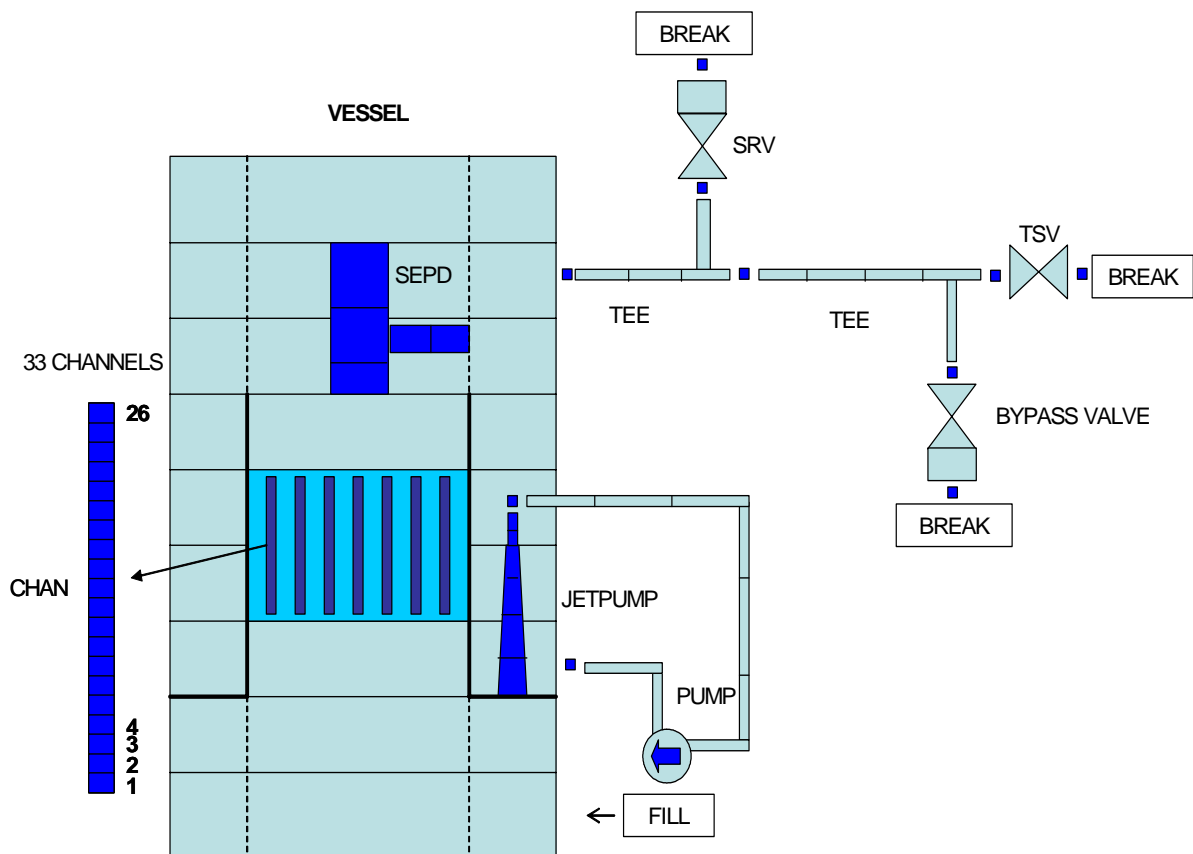
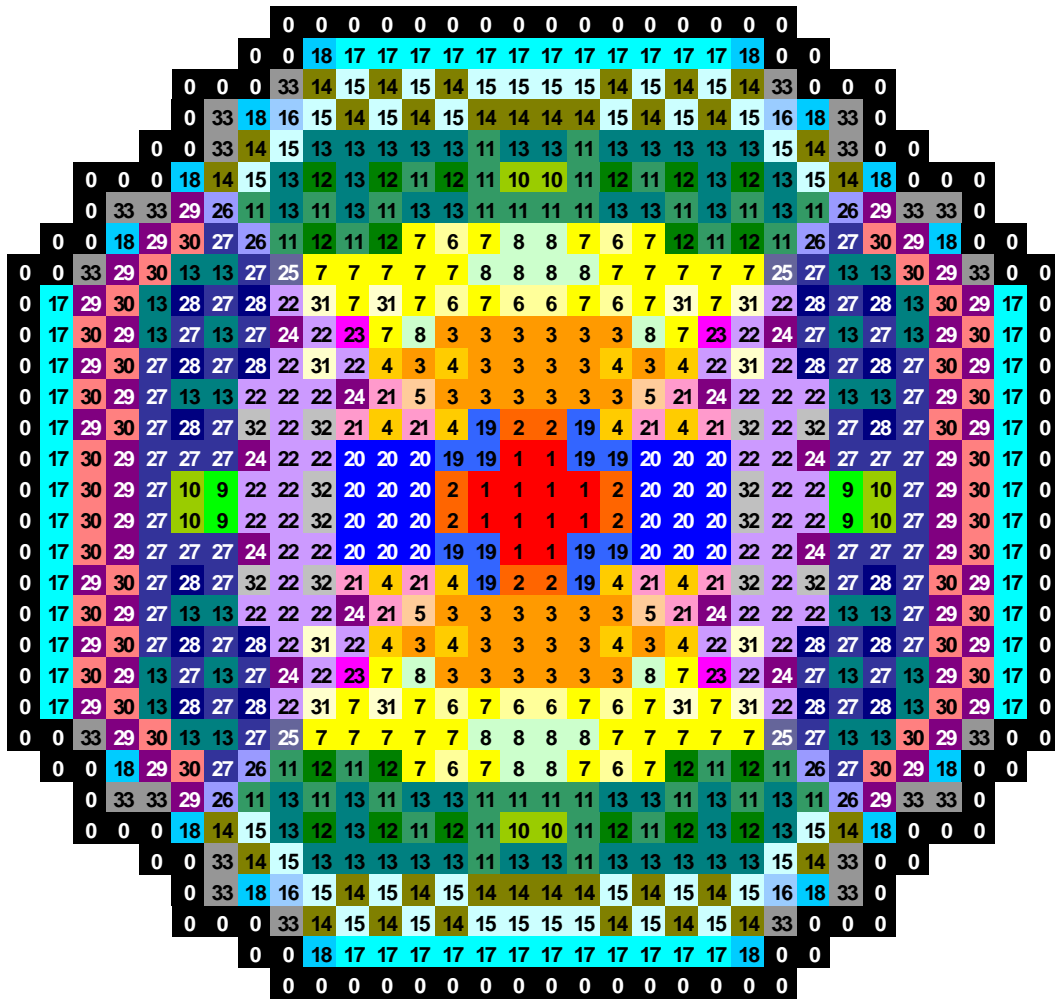
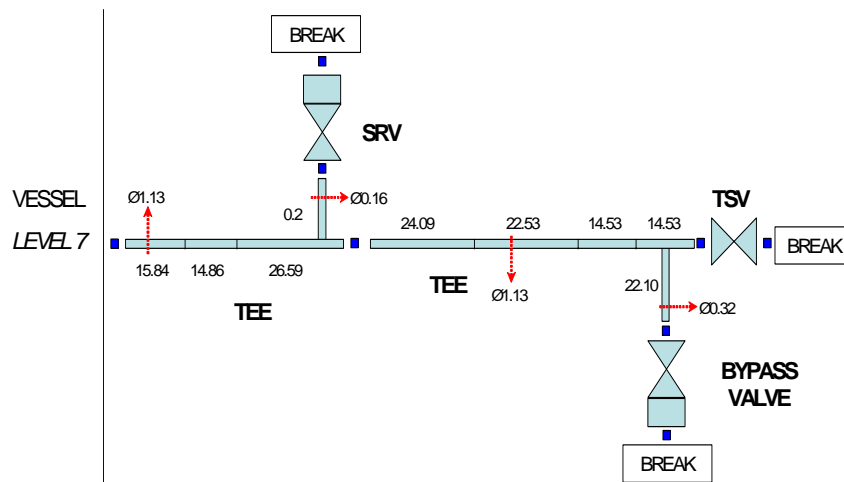

Figure B-26. UPV thermal-hydraulic channel map



c) Please provide in detail the nodalisation of the steam line.

Figure B-27. UPV steam line nodalisation



2. **Boundary conditions**

a) *Which core thermal-hydraulic initial and transient boundary conditions are used and how?*

We used the boundary conditions from specifications.

b) *Which neutronic/power initial and transient boundary conditions are used and how?*

The initial power was 2 030 MW, and the boundary conditions were from specifications.

3. **Component design and modelling**

a) *How many core bypass channels are used in this exercise?*

We did not use any bypass channels.

b) *How are the jet pumps modelled?*

The jet pumps are modelled with the jet pump component of TRAC-BF1. The primary tube has four cells and secondary one has two cells.

c) *How is the steam separator modelled?*

The steam separator was modelled with the TRAC-BF1 component SEPD.

d) *How are the turbine stop valve closing and steam bypass system modelled?*

The turbine valve closes at 0.096 s; it is specified in table provided by specifications on valve components.

The steam bypass system is modelled using the data from specifications.

e) *What were the difficulties encountered during the component design modelling?*

4. **General**

a) *Deviations from the updated final specifications?*

b) *User assumptions? Please provide the timestep(s) size or maximum and minimum values used for the simulation of Exercise 1.*

Timestep size of 0.1 s.

c) *Specific features of the codes used?*

d) *Number of solutions submitted per participant and how they differ?*

We submitted one solution.

e) *If your results are significantly different ($> 3\sigma$) than the measured or Exelon results, are there any explanations for these differences? Please explain each significant difference.*

POLCA-T (Westinghouse, Sweden)

1. Thermal-hydraulic model and nodalisation of the vessel and balance of the plant

a) What kind of nodalisation is used (1-D, 3-D and number of T-H channels or cells)?

Three-dimensional (3-D) nodalisation with 764 T-H channels, 24 fuel nodes and two nodes for the bottom and top reflector in each channel.

b) How are the volumes, junctions and channels/T-H cells chosen? (If possible, please provide schematic.)

One T-H channel per fuel assembly, 122 radial reflector channels.

c) Please provide in detail the nodalisation of the steam line.

Main steam lines are modelled by steam lines, safety and relieve valves, turbine stop valves and steam head with a total of 65 nodes and five valves.

2. Boundary conditions

a) Which core thermal-hydraulic initial and transient boundary conditions are used and how?

Power versus timetable, turbine pressure controller set point versus time, bypass valve position versus time and feedwater mass flow.

b) Which neutronic/power initial and transient boundary conditions are used and how?

See response to question 2a).

3. Component design and modelling

a) How many core bypass channels are used in this exercise?

One.

b) How are the jet pumps modelled?

The POLCA-T jet pumps model is used, which is validated against full and 1/6 scale test facility data and has nodalisation similar to that used in TRAC-M calculations.

c) How is the steam separator modelled?

The POLCA-T steam separator model is used, which is validated against our test data.

d) How are the turbine stop valve closing and steam bypass system modelled?

The turbine stop valve closing is modelled by a signal-activated turbine pressure controller. The controller's set point versus timetable is given as a boundary condition.

Bypass valve position versus time is given as a boundary condition. The steam bypass system model covers: bypass chest, bypass valves, lines and orifice, and steam condenser with a total of 51 nodes and one valve.

d) What were the difficulties encountered during the component design modelling?

There were no difficulties encountered during the component design modelling. However, to set up the plant model there was the need for a sensitivity study on some of the parameters [such as carry-under and carry-over, turbine stop valve closing (linear or non-linear model), and jet pump model to work along the M-N curve].

4. General

a) Deviations from the updated final specifications?

We did not see any.

b) User assumptions? Please provide the timestep(s) size or maximum and minimum values used for the simulation of Exercise 1.

Constant timestep as given in the specifications (0.006 s).

c) Specific features of the codes used?

Core description given in the input data of our neutronics code POLCA-7, POLCA-T steam separator model, POLCA-T jet pumps model, control rods speed and position controller, scram controller, jet pump drive flow controller, feedwater controller, RPV water level controller and turbine pressure controller.

d) Number of solutions submitted per participant and how they differ?

One solution.

e) If your results are significantly different ($> 3\sigma$) than the measured or Exelon results, are there any explanations for these differences? Please explain each significant difference.

OECD PUBLICATIONS, 2 rue André-Pascal, 75775 PARIS CEDEX 16
Printed in France.