

Radiation Protection Aspects of Primary Water Chemistry and Source-term Management

April 2014

Unclassified

NEA/CRPPH/R(2014)2

Organisation de Coopération et de Développement Économiques
Organisation for Economic Co-operation and Development

24-Jul-2014

English - Or. English

Nuclear Energy Agency

Cancels & replaces the same document of 20 June 2014

Committee on Radiation Protection and Public Health

RADIATION PROTECTION ASPECTS OF PRIMARY WATER CHEMISTRY AND SOURCE-TERM MANAGEMENT

Report

April 2014

This document cancels and replaces the previous version due to updates in the Executive Summary.

For any further information, please contact Mr. Burcin H. OKYAR (burcin.okyar@oecd.org)

JT03360680

Complete document available on OLIS in its original format

This document and any map included herein are without prejudice to the status of or sovereignty over any territory, to the delimitation of international frontiers and boundaries and to the name of any territory, city or area.

NEA/CRPPH/R(2014)2
Unclassified

English - Or. English

Radiological Protection

**Radiation Protection Aspects of Primary Water Chemistry
and Source-term Management**

© OECD 2014
[NEA/CRPPH/R\(2014\)2](#)

NUCLEAR ENERGY AGENCY
ORGANISATION FOR ECONOMIC CO-OPERATION AND DEVELOPMENT

ORGANISATION FOR ECONOMIC CO-OPERATION AND DEVELOPMENT

The OECD is a unique forum where the governments of 34 democracies work together to address the economic, social and environmental challenges of globalisation. The OECD is also at the forefront of efforts to understand and to help governments respond to new developments and concerns, such as corporate governance, the information economy and the challenges of an ageing population. The Organisation provides a setting where governments can compare policy experiences, seek answers to common problems, identify good practice and work to co-ordinate domestic and international policies.

The OECD member countries are: Australia, Austria, Belgium, Canada, Chile, the Czech Republic, Denmark, Estonia, Finland, France, Germany, Greece, Hungary, Iceland, Ireland, Israel, Italy, Japan, Luxembourg, Mexico, the Netherlands, New Zealand, Norway, Poland, Portugal, the Republic of Korea, the Slovak Republic, Slovenia, Spain, Sweden, Switzerland, Turkey, the United Kingdom and the United States. The European Commission takes part in the work of the OECD.

OECD Publishing disseminates widely the results of the Organisation's statistics gathering and research on economic, social and environmental issues, as well as the conventions, guidelines and standards agreed by its members.

NUCLEAR ENERGY AGENCY

The OECD Nuclear Energy Agency (NEA) was established on 1 February 1958. Current NEA membership consists of 31 countries: Australia, Austria, Belgium, Canada, the Czech Republic, Denmark, Finland, France, Germany, Greece, Hungary, Iceland, Ireland, Italy, Japan, Luxembourg, Mexico, the Netherlands, Norway, Poland, Portugal, the Republic of Korea, the Russian Federation, the Slovak Republic, Slovenia, Spain, Sweden, Switzerland, Turkey, the United Kingdom and the United States. The European Commission also takes part in the work of the Agency.

The mission of the NEA is:

- to assist its member countries in maintaining and further developing, through international co-operation, the scientific, technological and legal bases required for a safe, environmentally friendly and economical use of nuclear energy for peaceful purposes, as well as
- to provide authoritative assessments and to forge common understandings on key issues, as input to government decisions on nuclear energy policy and to broader OECD policy analyses in areas such as energy and sustainable development.

Specific areas of competence of the NEA include the safety and regulation of nuclear activities, radioactive waste management, radiological protection, nuclear science, economic and technical analyses of the nuclear fuel cycle, nuclear law and liability, and public information.

The NEA Data Bank provides nuclear data and computer programme services for participating countries. In these and related tasks, the NEA works in close collaboration with the International Atomic Energy Agency in Vienna, with which it has a Co-operation Agreement, as well as with other international organisations in the nuclear field.

This document and any map included herein are without prejudice to the status of or sovereignty over any territory, to the delimitation of international frontiers and boundaries and to the name of any territory, city or area.

Corrigenda to OECD publications may be found online at: www.oecd.org/publishing/corrigenda.

© OECD 2014

You can copy, download or print OECD content for your own use, and you can include excerpts from OECD publications, databases and multimedia products in your own documents, presentations, blogs, websites and teaching materials, provided that suitable acknowledgment of the OECD as source and copyright owner is given. All requests for public or commercial use and translation rights should be submitted to rights@oecd.org. Requests for permission to photocopy portions of this material for public or commercial use shall be addressed directly to the Copyright Clearance Center (CCC) at info@copyright.com or the Centre français d'exploitation du droit de copie (CFC) contact@cfcopies.com.

Foreword

Since 1992, the Information System on Occupational Exposure (ISOE) has provided a forum for radiological protection professionals from nuclear power utilities and national regulatory authorities worldwide to discuss, promote and co-ordinate international co-operative undertakings for the radiological protection of workers at nuclear power plants. The ISOE objective is to improve occupational exposure management at nuclear power plants by exchanging relevant information, data and experience on methods to optimise occupational radiation protection.

At its meeting in November 2010, ISOE Management Board discussed a new proposal on radiation protection aspects of primary system water chemistry and source-term management. It was indicated that there are many approaches to water chemistry in nuclear power plants with very various results and consequences in terms of radiation protection performance. As such, it was suggested that radiation protection aspects of primary system water chemistry and source-term management should be discussed by an ISOE ad-hoc expert group. The Group is expected to address the experience of various ISOE utilities with various water chemistry regimes to see if experience exchange could help to improve radiation protection performances. Members of the Management Board also noted that water chemistry should not be viewed only from the context of radiation protection issues, and it was proposed to be grouped into a few of the most commonly used water chemistry approaches (e.g. zinc injection, pH control, iron injection, hydrogen water chemistry, etc.) to focus the exchange of experience discussions. For each approach, it is expected to identify how radiation protection benefits are evaluated with a focus on measurement techniques such as CZT gamma spectroscopy.

The ISOE Management Board welcomed the proposal and decided that the Working Group on Data Analysis (WGDA) should take the lead in managing the work of this group. The Management Board also agreed that the ISOE Technical Centres should participate actively in this body of work, and that the Group should discuss its work with the CRPPH Expert Group on Occupational Exposure (EGOE), as appropriate to build on its experience. It was noted that this activity would benefit from a broad ISOE participation to ensure that the final product would be cohesive and valuable. Thus, it was requested that a call for nominations be sent by the Secretariat to the full Management Board. Following this direction, a call for nominations to the newly established ad-hoc expert group was sent to the ISOE membership in January 2011.

This report reflects the current state of knowledge, technology and experience on primary water chemistry and source-term management issues directly related with radiation protection.

ISOE Network: www.isoe-network.net

Table of Contents

Foreword	5
List of Acronyms	9
List of Figures	11
List of Tables	13
Executive Summary	15
1. Introduction	17
2. Scope	17
3. Introduction of Strategies and Techniques	18
3.1 Background on Radiation Field Generation	18
3.1.1 Fission Products	18
3.1.2 Coolant Activation Products	19
3.1.3 Activated Corrosion Products	21
3.1.4 Contribution of Radionuclides to Dose Rate	26
3.2 Material issues	27
3.2.1 Pressurised Water Reactors (PWRs)	28
3.2.2 Water-Water Energetic Reactors (VVERs)	32
3.2.3 Pressurised Heavy Water Reactors (PHWRs)	32
3.2.4 Boiling Water Reactors (BWRs)	33
3.2.5 Material and Technology options	34
3.2.6 Materials Overview Preventive Strategies	37
3.3 Overview of available chemical methods	37
3.3.1 Purification/Clean-up System Basics	37
3.3.2 Pressurised Water Reactors (PWRs)	45
3.3.3 Water-Water Energetic Reactors (VVERs)	52
3.3.4 Pressurised Heavy Water Reactors (PHWRs)	61
3.3.5 Boiling Water Reactors (BWRs)	65
3.4 Remediation of contamination during outages	67
3.4.1 Full system decontamination	67
3.4.2 Others	68
4. Radiation field measurement techniques	75
4.1 Dose rate measurement techniques	75
4.2 Germanium detector	77
4.3 CZT detector	78
4.4 Comparison between High Purity Germanium and CZT	79
5. Measurement locations and indices	79
5.1 Pressurised Water Reactors (PWRs)	80
5.1.1 EDF methodology	80
5.1.2 EPRI methodology	84
5.1.3 Hot spots	88
5.2 Water-Water Energetic Reactors (VVERs)	89
5.2.1 Dose rate measurements	89
5.2.2 <i>In situ</i> gamma spectrometry	92

5.3 Boiling Water Reactors (BWRs)	96
5.3.1 EPRI methodology	96
5.3.2 ASEA Atom methodology at Vattenfall	98
6. Conclusions	99
Appendix 1: Typical Primary Materials for PWRs	101
Appendix 2: Strategy for Implementing an Optimised CZT programme	103
Appendix 3: ISOE Programme Information	115
Appendix 4: ISOE Expert Group on Water Chemistry and Source-Term Management	117
References	119

List of Acronyms

AAS	Aqua-Aerobic System
ALARA	As Low as Reasonably Achievable
ANDRA	<i>Agence nationale pour la gestion des déchets radioactifs</i> , National French Agency for Radioactive Waste Management
AOA	Axial Offset Anomaly
BOC	Beginning of Cycle
BRAC	BWR Radiation Level Assessment and Control
BWR	Boiling Water Reactor
CANDU	Canada Deuterium Uranium Reactor
CEPN	<i>Centre d'étude sur l'Évaluation de la Protection dans le domaine Nucléaire</i> , Nuclear Protection Evaluation Centre
CIPS	Crud Induced Power Shift
CRPPH	Committee on Radiation Protection and Public Health
CRUD	Chalk River Unidentified Deposits
CVCS	Chemical and Volume Control System
CZT	Cadmium-Zinc-Tellurium
DCD	Dilute Chemical Decontamination
DF	Decontamination Factor
DPNGS	Douglas Point Nuclear Generating Station
ECP	Electrochemical Potential
ED	Electronic Dosimeter
EDF	<i>Électricité de France</i> , French Electricity Utility
EPFY	Effective Full Power Year
EGOE	Expert Group on Occupational Exposure
EMECG	<i>Ensemble de Mesure et d'Étude de la Contamination des Circuits</i> , Assembly of Measuring and Study of Circuit Contamination
EOC	End of Cycle
EP	Electropolishing
EPRI	Electric Power Research Institute
FSD	Full System Decontamination
HFT	Hot Functional Test
HIC	High Integrity Container
HTS	Heat Transport System
HWC	Hydrogen Water Chemistry
IASCC	Irradiation Assisted Stress Corrosion Cracking
IGSCC	Intergranular Stress Corrosion Cracking
ISOE	Information System on Occupational Exposure
LOMI	Low Oxidation-state Metal Ion
MADAC	Mobile Analyser for the Detection of Activity in Crud

NDE	Non-destructive Evaluation
NIVDS	Nuclear Island Drain/Vent System
NPD	Nuclear Power Demonstration
NPP	Nuclear Power Plant
NSSS	Nuclear Steam Supply Systems
NWC	Normal Water Chemistry
PHWR	Pressurised Heavy Water Reactor
PMUC	Products and Materials used in Power Plants
PWR	Pressurised Water Reactor
PWSCC	Primary Water Stress-Corrosion Cracking
RB	Reactor Building
RBMK	<i>Reaktor Bolshoy Moshchnosti Kanalnyi</i> , High Power Channel-type Reactor
RCA	Reactor Containment Area
RCPB	Reactor Coolant Pressure Boundary
RCS	Reactor Coolant System
RHRS	Residual Heat Removal System
RWCU	Reactor Water Clean-up System
RTD	Resistance Temperature Detector
SCC	Stress Corrosion Cracking
SCrP	Stabilised Chromium Process
SG	Steam Generator
SRMP	Standard Radiation Monitoring Programme
TCLP	Toxic Characteristic Leach Procedure
TLD	Thermo-Luminescent Dosimeter
TT	Thermally Treated
VCT	Volume Control Tank
VVER	<i>Vodo-Vodyanoi Energetichesky Reactor</i> , Water-Water Energetic Reactor
WGDA	Working Group on Data Analysis

List of figures

Figure 1.	Generic PWR process of corrosion product transport	21
Figure 2.	EDF 900 MWe Fleet ⁵⁸ Co deposited activity on hot legs over cycles	29
Figure 3.	EDF 900 MWe Fleet ⁵⁸ Co oxygenation peaks	29
Figure 4.	Post-steam generator replacement of ⁵⁸ Co peaks (μCi/ml)	30
Figure 5.	Schematic representation of the oxide grown in high temperature primary water on tubes made of alloy 690TT	35
Figure 6.	Preventive filtration methods	36
Figure 7.	Half-life Impact on Purification Half-life	40
Figure 8.	Resin Efficiency Impact on Purification Half-life	41
Figure 9.	Projected Clean-up Time based on Clean-up flows	42
Figure 10.	Projected Clean-up Time based on Efficiency Improvements	43
Figure 11.	Factors Impacting Purification Half-life	44
Figure 12.	EDF B/Li Ratio and pH	46
Figure 13.	Diagram of the three used or foreseen B/Li coordination in EDF PWRs	47
Figure 14.	VVER-1000 Primary Circuit Layout	52
Figure 15.	Boron/potassium co-ordination for the standard and modified/updated water chemistry of VVER-440 units	53
Figure 16.	Boron/potassium co-ordination for the standard and modified/updated water chemistry of VVER-1000 units	54
Figure 17.	Example of typical pH _(300° C) for the standard and modified water chemistries during the reactor cycle (VVER-440 unit) [8]	54
Figure 18.	Hydrogen/ammonia ratio at Russian NPPs with reactors VVER-440 and 1000 [8]	55
Figure 19.	Primary chemistry and primary loop surface activities history of VVER-440 unit EBO-3	56
Figure 20.	NPP Dukovany-4 primary chemistry	57
Figure 21.	NPP Dukovany-4 primary loop activities	57
Figure 22.	NPP Bohunice Unit EBO-3 Comparison of primary coolant pH(300)	58
Figure 23.	NPP Bohunice Unit EBO-3 Primary surface activities	59
Figure 24.	NPP Bohunice Unit EBO-3 Comparison of primary coolant pH (300) for Best and Worst Cycles	59
Figure 25.	Surface activities measured after first and second cycle of Mochovce-1 (partial HFT passivation) and Mochovce-2 (good HFT passivation)	61
Figure 26.	Processes involved in PHWR activity transport [Guzonas, 2010]	62
Figure 27.	Average contamination levels on the 1 st loop of Loviisa 2 (8 points). In 1994 and 1995 the MARC measurements were made twice to follow up the decontamination and recontamination	68
Figure 28.	Trending of the activity concentration on the 1 st SG hot side on LO1 not ever decontaminated	69

Figure 29.	Trending of the activity concentration on the 3 rd SG hot side on LO1 decontaminated in 1980. The concentration of Co is slightly lower than on the surface of the loops, but the concentration of Sb slightly higher	69
Figure 30.	Seabrook Submersible Tri Nuclear Demineraliser	73
Figure 31.	Tri Nuclear Submersible Demineraliser Configuration	73
Figure 32.	Tri Nuclear Photo and Engineering Plane View of Submersible Demineraliser	74
Figure 33.	Tri Nuclear View of Submersible Demineraliser	74
Figure 34.	CZT principle diagram	78
Figure 35.	Localisation of RCS index measurement points	80
Figure 36.	Example of cartography at level +11m (900-series)	81
Figure 37.	EMECC Device	82
Figure 38.	Measurement point localisation during shutdown	83
Figure 39.	Evolution of ⁶⁰ Co deposited activities on hot legs (24a) and steam generator tubes (24b)	83
Figure 40.	Typical Westinghouse 4-Loop Plant With Piping and Steam Generator Survey Points Marked	86
Figure 41.	Westinghouse Plant Channel Head Survey Points	88
Figure 42.	Measuring points of dose rates at VVER-440 reactors	89
Figure 43.	Comparison of primary loop dose rate averages for VVER reactors	90
Figure 44.	NPP Bohunice primary loop dose rates in period 2000–2012 by loops	90
Figure 45.	NPP Bohunice primary loop dose rates in period 2000–2012 by measurement points	91
Figure 46.	NPP Paks Unit 1 primary loop dose rates in period 1984–2009 by measurement points	91
Figure 47.	Measurement points scheme at Czech and Slovak NPPs Bohunice and Mochovce, Dukovany	92
Figure 48.	Primary loop piping mock up made purposely for NDT calibration/validation which was used for real efficiency calibration at Slovak NPP Bohunice	93
Figure 49.	Real measurement arrangement at Czech NPP Dukovany	93
Figure 50.	Steam generator measurement at Hungarian NPP Paks	94
Figure 51.	Activity profile measurement of primary clean-up filter at Czech NPP Temelin	94
Figure 52.	Average contamination levels on the 1 st loop of Loviisa 1 (8 points) – values in kBq/cm ²	95
Figure 53.	Average primary loop contamination levels on the PAKS-1 unit – values in kBq/cm ²	95
Figure 54.	Average primary loop contamination levels on the Bohunice-3 unit – values in kBq/cm ²	96
Figure 55.	BWR radiation sampling points for typical BWR recirculation piping	97
Figure 56.	Portable HPGe detector with collimated shielding for a BWR MADAC based measurement campaign, here measuring on a BWR-75 steam pipe (Forsmark 3)	99

List of tables

Table 1.	Origin of the main activation products present in the primary cooling system from the primary coolant, primary coolant impurities or reactor building air	20
Table 2.	Origin of the main activation products present in the primary cooling system from structures or corrosion mechanism	23
Table 3.	Source terms components – Summary table	27
Table 4.	Typical PWR materials of construction	28
Table 5.	Example Modern PWR Fuel Assembly Materials of Construction	31
Table 6.	Typical Coolant Concentrations	44
Table 7.	Relative Corrosion Rates versus primary pH _T	45
Table 8.	^{110m} Ag peak activity, 900 and 1.300 MWe French Standardised plant series in 2007	49
Table 9.	Mean and maximum volumetric activities encountered at the oxygenation peak on the EDF fleet (1995-2007)	51
Table 10.	RCS recontamination after a ¹²⁴ Sb peak of 70 GBq/m ³	51
Table 11.	Bearing replacement consequence during the 14 th cycle	52
Table 12.	Resins Loading on Underwater Demineraliser at Seabrook Station	75
Table 13.	High Purity Germanium to CZT detectors	79
Table 14.	Example of an EMECC programme performed in 2009 on a EDF 4-loop unit	82
Table 15.	CZT optimised programme	84

Executive Summary

Since the beginning of the 1990s, occupational exposures in nuclear power plant has strongly decreased, outlining efforts achieved by worldwide nuclear operators in order to reach and maintain occupational exposure as low as reasonably achievable (ALARA) in accordance with international recommendations and national regulations. These efforts have focused on both technical and organisational aspects. According to many radiation protection experts, one of the key features to reach this goal is the management of the primary system water chemistry and the ability to avoid dissemination of radioactivity within the system. It outlines the importance for radiation protection staff to work closely with chemistry staff (as well as operation staff) and thus to have sufficient knowledge to understand the links between chemistry and the generation of radiation field. This report was prepared with the primary objective to provide such knowledge to 'non-chemist'.

The main contributors to the radiation field generation (and then to the collective dose during outage) are activated corrosion products. The most important radionuclides from a radiation perspective are ^{58}Co , ^{60}Co , $^{110\text{m}}\text{Ag}$, $^{124,5}\text{Sb}$, ^{59}Fe , ^{54}Mn , ^{51}Cr , ^{95}Zr , and ^{95}Nb . Two main sources are usually defined for these radionuclides: out-of-core corrosion products (steam generator corrosion products, etc.) and fuel assembly and/or materials corrosion products (reactor internals, etc.). The first possibility to limit radiation field generation is to limit corrosion of materials and the second is to limit concentration of elements such as Ni and Co in these materials (e.g. playing on plant design, flow and chemistry of the primary coolant). From a radiation protection perspective, "the most important material issue is the corrosion resistance of the material".

It is possible to limit corrosion by playing on the manufacturing process of the component so as to limit corrosion – electropolishing process, surface preconditioning, etc. –. This is in particular the case for steam generators in PWRs (corrosion of steam generator tubes is the principle source of ^{58}Ni). To reduce Co inventories, many plants have successfully implemented long-term cobalt reduction programmes based on a detailed characterisation of cobalt sources and the definition of a cobalt sources removal strategy (which can only be achieved on a long-term range).

Purification systems play a major role in decreasing activity concentration in the primary coolant and have a major influence on occupational exposure during outage for refuelling and/or maintenance. The design of the purification system depends on the plant design. They basically consist in filters – removal of particulate with 0.05 to 40 μm filters – combined with demineralisers – removal of ionic impurities –. Resins may be designed to remove specific radionuclides or to have improved removal of all impurities. The application of macro-porous resins and other speciality resins has been identified in improvements in overall source-term reduction strategies. One key issue nowadays is to optimise the purification process in order to catch up with the need to shorten outage duration. This requires close collaboration between radiation protection, chemistry and operation staff.

During operation, the chemistry staff can play on pH adjustment, hydrogen control and zinc injection to limit corrosion and thus optimise nickel release into the primary coolant. For western PWRs, through the B/Li coordination, which sets the lithium concentration according to the boric acid concentration, optimum $\text{pH}_{\text{Temperature}}$ is generally

defined between 7.2 and 7.4 depending on the alloys used in the primary system. Zinc injection into reactor coolant system benefits relating to radiation fields have been identified since the 1980s. It has been successfully tested in approximately 70 PWRs since the mid-1990s. In addition, even if the popularity of zinc injection is due to its fast impact on surface contamination, the main interest of zinc injection is its multiple benefits not only for dose rates reduction but also for Primary Water Stress-Corrosion Cracking (PWSCC) and Axial Offset Anomaly (AOA) mitigation. Zinc injection is not implemented for VVERs, mainly because of differences in material concept, which leads to much lower cobalt isotope activities. For those reactors, studies are still carried out in order to assess efficiency of Zinc injection, while it is not recommended for PHWR's heat transport systems. In addition to practices described above, the operator can remediate high level of contamination in various ways, depending on its extent: full system decontamination (e.g. Low Oxidation-state Metal Ion (LOMI) or Chemical Oxidation Reduction Decontamination (HP/CORD UV) process for BWRs, HP/CORD UV for PWRs), system or component decontamination [implementation of EMMAC process (using nitric permanganate and ascorbic acid for chemical decontamination) on EDF fleet] or flushing (mechanical removal of hot spots), considering most common remediation practices.

In order to assess efficiency of strategy to minimise contamination of the primary coolant and component and associated radiation field generation, radiation protection staff may rely on various measurement techniques. Regarding the needs (area monitoring, purification follow-up, hot spots characterisation, etc.), proper selection of survey instrumentation (radiation survey meter, electronic dosimeters, germanium detector, Cadmium-Zinc-Tellurium (CZT) detector, remote techniques, etc.) is important to provide accurate dose rate readings at the intended measurement locations by taking into account all factors that may influence the data.

A careful attention must be paid to measurement point locations considering plant specificities. For trending of source terms over long time period, for instance, points must be clearly identified and remain constant over time. Measurement must be achieved with the same instrument and at the same time after shutdown to allow for relevant comparison and follow-up. Specific procedures and physical marking may help to achieve this. EPRI developed its Standard Radiation Monitoring Programme (SRMP) in 1978.

Management of the primary system water chemistry has been, and still is, a major contributor to collective dose reduction programmes of the nuclear power plants. It must be taken into account at all stage of the facility life: its design and commissioning (choice of material, design of clean up system), during its operation (operation chemistry, shutdown procedures, zinc injection, full system chemical decontamination, flushing) and its decommissioning (full system decontamination). It is obvious that an optimised strategy requires involvement and collaboration between all stakeholders; mainly operation, radiation protection and chemistry staff, and a strong support from the management in order to cope with all priorities (e.g. shortening the duration of outage). Benchmarking as well as inputs from experts institutes may also play a key role. This report aims to provide information to facilitate the dialogue between all these actors.

1. Introduction

During the 50 years of successful commercial nuclear power plant electrical generation, the importance of water chemistry management and radioactive source term reduction became key aspects of the sustainability and life-cycle management practices for the first and second generation reactors.

An example of the lessons learned in proper water chemistry management and plant component reliability is the failure of PWR steam generators in the 80s, 90s and beyond due to poor water chemistry regimes leading to tube failure and plugging. Replacement steam generators have precluded the degradation of the component based on improved water chemistry controls.

A wide range of annual dose values is observed in the current global fleet of operating PWRs, BWRs, PHWR and VVERs. The report details and explains the cause of water chemistry and source-term management, good practices and application of lessons learned and challenges related to source-term reduction efforts for a better understanding on materials and fuel limitations and is a value of international information exchange and also a value of multiple NSSS designs globally. Topics addressed include:

- Water Chemistry Controls.
- Reactor Shutdown Protocols.
- Chemical Decontamination Experience.
- Source Term Removal.
- Instrumentation for Source Characterisation.

In general, the ISOE expert group report focuses on globally informed life cycle plant management with the goal of asset preservation and low occupational dose and public dose management.

2. Scope

The publication primarily focuses on three topics dealing with water chemistry, source term management and remediation techniques. One key objective of the report is to provide current knowledge regarding these topics and to address clearly related radiation protection issues. In that mind, the report prepared by the EGWC was also reviewed by radiation protection experts. In order to address various designs, PWRs, VVERs, PHWRs and BWRs are addressed within the document. Additionally, available information addressing current operating units and lessons learnt is outlined with choices that have been made for the design of new plants.

Chapter 3 of this report addresses current practices regarding primary chemistry management for different designs, “how to limit activity in the primary circuit and to minimise contamination”. General information is provided regarding activation, corrosion and transport of activated materials in the primary circuit (background on radiation field generation). Primary chemistry aspects that are related to radiation field generation are addressed, such as material issues (steam generator, cobalt inventory, surface preconditioning and fuel assembly support structure material) and chemical methods (pH control, zinc injection, shut down and start-up operations and purification) are also addressed. Specific contamination with ^{110}Ag or ^{124}Sb is also discussed.

Chapter 4 – radiation field measurement techniques – provides information regarding measurement techniques and mapping strategies (such as the EPRI methodology or the EDF RB index) that are used in order to precisely follow radiation field evolution within the RB and to detect abnormal elevation of dose rate. Routine measurements with common techniques such as routine dose rate meters are described as well as more complex techniques such as CZT detectors or germanium detector. Advantages and disadvantages of both techniques are discussed. In the follow up of the report, techniques for full system and component remediation are discussed with quantitative data sets “remediation of contamination”. Experiences of various sites with respect to source term management are provided, addressing the topics previously discussed in the report in section titled as “radiation protection outcomes”.

3. Introduction of Strategies and Techniques

3.1 Background on Radiation Field Generation

The reactor coolant chemistry is complex. It involves soluble and insoluble (colloidal and larger particulates) species in a forced-convective, non-isothermal system. Complex processes control the release of corrosion products to the coolant, resulting in the potential activation from the intense neutron field present in operating reactor cores. Corrosion products undergo a series of processes to reach ex-core surfaces producing the radiation field. These processes include release, transport to the fuel surface, deposition, activation, release from fuel surfaces, and the subsequent uptake on out-of-core surfaces. Through the process of generating energy and by exposing the released corrosion products to the neutron flux, a significant inventory of radioactive corrosion products is created over time, which in turn, can be transported and deposited on ex-core surfaces. This results in the build-up of radiation fields impacting worker dose.

There are essentially three types of activity that the plant chemists and radiation protection professionals / health physicists are concerned with; fission products, coolant activation products and activated corrosion products. Activated corrosion products can then be sorted into two additional groups; corrosion products deposited on fuel surfaces from out-of-core surface corrosion and highly activated corrosion products from fuel and reactor materials.

Section 3.1 covers the basics related to activity release and build-up on system surfaces. It is not intended to provide a detailed discussion of different NSSS designs. As an example, differing chemistry conditions are maintained in light water western style PWR, BWR and VVER designs; combined with the different materials of construction, unique situations for each design are created. These designs are discussed in later sections.

3.1.1 Fission Products

In order to understand the fission sources, one must consider the source of “fissile material”. The primary fissile materials in light water reactors after initial start-up include ^{235}U (natural and enriched), ^{239}Pu (neutron capture with ^{238}U), and ^{241}Pu (neutron capture with ^{240}Pu). ^{235}U and ^{239}Pu isotopes are the primary drivers for nuclear fission while the others support the longer operating cycle supporting continued fission. Other fissile materials may include ^{238}Np , ^{243}Pu , ^{241}Am , ^{242}Am , ^{244}Am and ^{242}Cm , ^{243}Cm , ^{244}Cm , and ^{245}Cm .

Fresh PWR and BWR fuel consists of ~4% enriched ^{235}U with a balance of ^{238}U (~96%), ^{234}U and ^{236}U (less than 1%); PHWR fuel contains natural uranium. The ^{235}U is the fissile material in new (fresh) fuel assemblies, while ^{239}Pu and ^{241}Pu are produced or converted to fissile material by neutron capture after start-up. These fissile materials are essential for the long-term operation of plants. Based on (G Friedlander, 1981), for approximately every

1 megawatt day of reactor operation, 1 gramme of fissile material undergoes fission and approximately 0.5 grams of ^{239}Pu is produced.

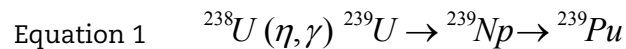

Actinides can create unique challenges for radiation protection personnel. The potential issues related to alpha contamination and system clean-up following fuel failures requires diligence and significant effort to minimise worker dose-related issues. In general, for plants operating without fuel failures, this is not an issue for normal refuelling outage operation, but should be considered in the overall source term discussion.

During the fission reaction, the heavy nucleus is generally divided into two unequal mass nuclei called “fission products” consistent with the equation (2).



It is estimated that 3×1.010 fissions per second is required for every watt of power. Noting that during each fission, two fissions products are produced, one can easily show that the fission product inventory is the largest source of radionuclides in the primary system. With intact cladding, fission product release to the coolant is minimised, and coolant activation products and activated corrosion products dominate. If there are high levels of tramp material and/or fuel cladding leakage, the impact of fission products can be a significant contributor to the overall source term that radiation protection must consider in relation to worker dose. In the absence of tramp material and/or fuel cladding leakage, corrosion products, while representing a fraction of the overall inventory, dominate the source term when considering dose to workers.

3.1.2 Coolant activation products

Coolant activation products are those radionuclides come from water activation, impurities contained in water, or chemicals injected into the primary circuit. The principle activation products of concern in the coolant are identified in Table 1. In general, these species are not a concern for worker related dose, but they may be a concern related to effluents. Two exceptions include ^{41}Ar early in the shutdown for plants injecting argon gas and ^3H related to the PHWR design. ^3H presents some unique challenges and radiation protection personnel should understand the impact related to dose.

Three radionuclides of concern (^{14}C , ^{16}N , and ^{18}F) are briefly discussed below capturing some of the variables involved in coolant activation products. ^{18}F is only discussed reflecting the dependence on core design.

^{14}C provides some unique challenges due to its long half-life and potential impact on the environment. The primary production mechanism (outside of interactions within the fuel) is from the (n, p) interaction with ^{17}O , rather than the ^{14}N production mechanism, since the coolant is typically degassed and has a low dissolved nitrogen content. However, it should be noted that this is not the case for the VVER fleet injecting ammonia. The ^{14}N production mechanism plays more of a role in the VVER fleet.

The ^{16}O contained within the water molecule (H_2O) interacts with fast neutrons in a (n, p) reaction forming ^{16}N . ^{16}N is one of the highest, if not the highest concentration radioactive constituent in the coolant during power operations. The reaction is even more complicated, with the proton recoil reaction leading to the formation of ^{13}N . The resulting high energy gamma (~6 MeV) is one of the limiting factors related to

containment entries in PWRs and drywell entries and steam dependent entries in BWRs. This high energy gamma is the basis for many system designs that allow for the short-lived ^{16}N decay.

^{18}F provides an example where a coolant activation product is of little consequence. The production of this isotope is mostly determined by core design and is directly related to the neutron flux. Fast neutrons collide with H_2O molecules, or more precisely interact with the hydrogen atoms producing recoil protons, which in turn react with ^{18}O forming ^{18}F . The combination of the short half-life and low energy gamma of ^{18}F results in this radionuclide being of little significance to the overall source term.

Table 1 captures some of the more common coolant activation products with the reaction and source for consideration.

Table 1: Origin of the main activation products present in the primary cooling system from the primary coolant, primary coolant impurities or reactor building air

Activation Product	Reaction	Half-life	Source/Notes
^{16}N	$^{16}\text{O}(n,p)^{16}\text{N}$	7.13 seconds	Activation of ^{16}O in the coolant
^{13}N	$^{16}\text{O}(p,\alpha)^{13}\text{N}$	9.96 minutes	Activation of ^{16}O in the coolant and the prompt interaction of the proton recoil from the reaction above
^{18}F	$^{18}\text{O}(p,n)^{18}\text{F}$	109.7 minutes	Activation of ^{18}O by proton recoil in the coolant
^3H	$^{10}\text{B}(n,\alpha)^7\text{Li}(n,n\alpha)^3\text{H}$ $^{10}\text{B}(n,2\alpha)^3\text{H}$ $^6\text{Li}(n,\alpha)^3\text{H}$ $^6\text{Li}(n,n\alpha)^3\text{H}$	12.3 years	Activation of ^{10}B and ^6Li injected in reactor coolant to control reactivity and pH respectively and release from secondary start-up sources (antimony – beryllium)
^{42}K		12.36 hours	Activation of K injected in reactor coolant to control pH at VVER reactors
^{14}C	$^{17}\text{O}(n,\alpha)^{14}\text{C}$ $^{14}\text{N}(n,p)^{14}\text{C}$ $^{13}\text{C}(n,\gamma)^{14}\text{C}$	5730 years	Activation of ^{17}O contained in reactor coolant and into uranium oxide
^{41}Ar	$^{40}\text{Ar}(n,\gamma)^{41}\text{Ar}$	1.83 hours	Activation of ^{40}Ar contained in the reactor pit ventilation air (BWR) or the reactor coolant
^{38}Cl	$^{37}\text{Cl}(n,\gamma)^{38}\text{Cl}$	37 minutes	Activation of ^{37}Cl contained in coolant as impurity
^{24}Na	$^{23}\text{Na}(n,\gamma)^{24}\text{Na}$	23 hours	Activation of ^{23}Na contained in coolant as impurity
^{65}Zn	$^{64}\text{Zn}(n,\gamma)^{65}\text{Zn}$	244 days	Activation of ^{64}Zn contained in coolant as impurity or from natural zinc injection. This may be a significant contributor to shut-down dose rates

3.1.3 Activated Corrosion Products

Activated corrosion products represent the largest challenge to plant personnel related to source term. The activated corrosion products can be further divided into two different sources; out-of-core corrosion products and fuel assembly/materials of fuel construction corrosion products. These longer lived activated corrosion products are captured within the oxide layers of piping surfaces and create the radiation fields that workers are challenged with in today's nuclear fleet.

Metallic non-radioactive corrosion and wear products are affected by coolant chemistry (pH_T , Zn and H_2), as well as local velocity (wall shear forces) and temperature and exist as dissolved, colloidal or particulate species. These species may deposit on fuel rod surfaces by precipitation, adsorption, or particle deposition and activate by absorbing a fast or thermal neutron. Several processes can cause the re-entrainment or release of the deposited material back into the coolant, including, but not limited to, erosion, thermal hydraulic changes, and chemistry changes such as changes in redox potential or pH. Activation products are transported to ex-core surfaces and can be deposited or absorbed in out-of-core surfaces (oxides) or collected in low flow areas. Figure 1 is an overview of this process related to the pressurised water fleet.

Figure 1: Generic PWR process of corrosion product transport

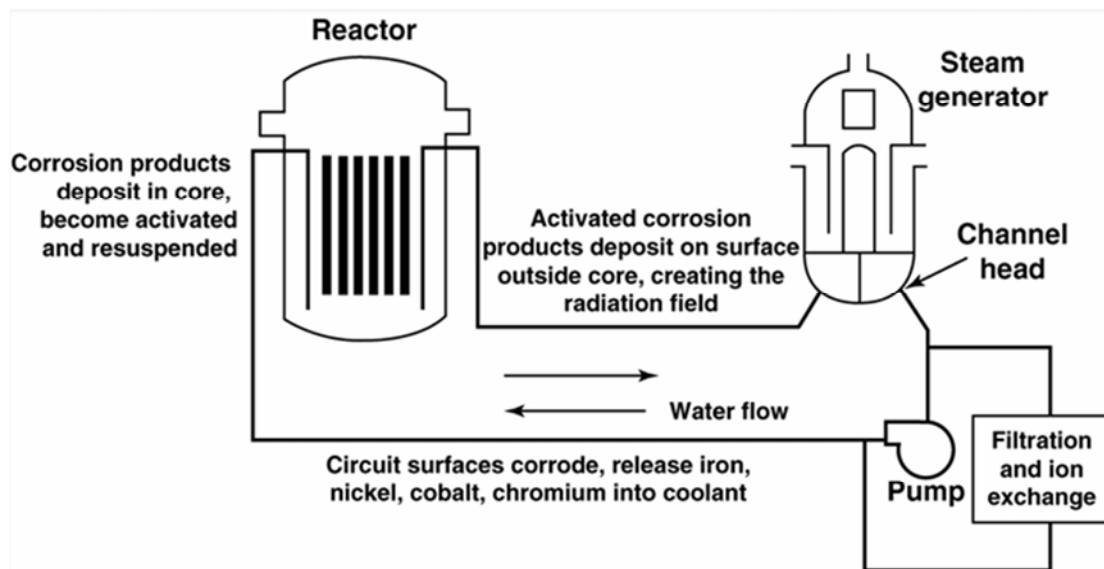

In early plant designs, site personnel were challenged by material selection issues that gave rise to various activation product source terms (high Co-59 Stellite™ applications, etc.). As material and fuel reliability concerns lead to component replacements, NSSS and fuel vendors adopted newer materials to address identified issues. One consideration was in the selection of materials that contained lower cobalt and nickel content to minimise the activated corrosion product inventory. Some examples include;

- Fuel vendors replaced Inconel¹-based fuel grids with Zircaloy-based materials to reduce the amounts of nickel and of associated cobalt impurities.
- The fuel cladding materials was replaced with material having lower cobalt content

1. Inconel is the registered trademark of Special Metals Corporation referring to group of austenitic nickel-chromium-based superalloy.

- SG tubing was originally replaced with Alloy 600, and for later replacements, Alloy 690 and 800 nickel content and lower cobalt impurity concentrations

The dose rate impact of these activated corrosion products tend to build up over a few years following initial start-up before an equilibrium level is reached. Changes in the chemistry regimens or system/component decontaminations can alter these fields over time, but in general these changes have little impact on ^{60}Co dominated radiation fields with the exception of decontaminations. Understanding the processes of release and deposition, combined with the plant limitations, provides personnel with the ability to begin evaluations of the various tools available to manage radiation fields.

Equation 3 shows the basic activation equation accounting for decay as well as build-up. The amount of a radionuclide generated by neutron activation depends on the neutron flux intensity, neutron absorption cross-sections, irradiation duration (the time the species are exposed to the neutron flux).

$$\text{Equation 3} \quad A_i = N\sigma\phi(1 - e^{-\lambda t})$$

Where:

A	=	Activity
N	=	Number of atoms available for activation
σ	=	Neutron cross section
ϕ	=	Neutron flux
λ	=	Decay constant ($\ln(2)/T_{1/2}$)
t	=	Time since activation

The source term for activated corrosion products can be defined, as any parent or radioactive nuclide that is outside the fuel cladding, and which may transport through the primary circuit. The selection of significant radionuclides is based on half-life, concentrations, and gamma scan data. The main contributors, based on gamma scan campaigns, include ^{58}Co , ^{60}Co , $^{110\text{m}}\text{Ag}$, $^{124,5}\text{Sb}$, ^{59}Fe , ^{54}Mn , ^{51}Cr , ^{95}Zr and ^{95}Nb . Each of these radionuclides is subject to deposition or absorption on ex-core surfaces contributing to the radiation field build-up, or removal on purification media (resins or filters). It should be noted that ^{51}Cr typically does not present dose rate issues during shutdown due to the low energy decay gamma.

Table 2 captures the dominant radionuclides observed in the nuclear power fleet with the source, activation process, and common sources based on supporting research from multiple references. In general, these specific isotopes dominate the overall source term related to long term dose rates. There are many other activated corrosion products identified in Table 2 for a variety of reasons including half-life and expected concentrations. For example, ^{55}Fe , ^{59}Ni and ^{63}Ni are present in the coolant at very low levels and can impact waste stream classifications. In some cases, these radionuclides become more of a concern if the primary circuits are open for maintenance, due to the accompanying β -emission.

Antimony and silver present unique challenges during shut-down operations. Shutdown chemistry controls may require adjustment and additional dosimetry evaluations may be required. These radionuclides will be discussed in later sections.

Table 2: Origin of the main activation products present in the primary cooling system from structures or corrosion mechanism

Radionuclide	Half Life	Activation Reaction	Major Source
⁵¹ Cr	27.702 days	⁵⁰ Cr (n,) ⁵¹ Cr	Stainless steel and nickel based alloy
⁵⁴ Mn	312.1 days	⁵⁴ Fe (n,p) ⁵⁴ Mn	Stainless steel and nickel based alloy
⁵⁵ Fe	2.73 years	⁵⁴ Fe (n,) ⁵⁵ Fe	Stainless steel and nickel based alloy
⁵⁶ Mn	2.578 hours	⁵⁵ Mn (n,) ⁵⁶ Mn	Stainless steel and nickel based alloy
⁵⁸ Co	70.88 days	⁵⁸ Ni (n,p) ⁵⁸ Co	Nickel alloys
⁵⁹ Fe	44.51 days	⁵⁸ Fe (n,) ⁵⁹ Fe	Stainless steel and nickel based alloy
⁵⁹ Ni	7.46E4 years	⁵⁸ Ni (n,) ⁵⁹ Ni	Stainless steel and nickel based alloy
⁶⁰ Co	5.271 years	⁵⁹ Co (n,) ⁶⁰ Co	Stellite™ and cobalt bearing components
⁶⁴ Cu	12.701 hours	⁶³ Cu (n,) ⁶⁴ Cu	17-4 PH Steel
⁶⁵ Zn	243.8 days	⁶⁴ Zn (n,) ⁶⁵ Zn	Natural zinc injection
⁹⁵ Nb	34.97 days	⁹⁵ Zr decay	Fuel cladding (Zircaloy, Zirlo™, etc.)
⁹⁵ Zr	64.02 days	⁹⁴ Zr (n,) ⁹⁵ Zr	Fuel cladding (Zircaloy, Zirlo™, etc.)
⁹⁹ Tc	2.13E5 years	⁹⁸ Mo (n,) ⁹⁹ Mo ⁹⁹ Tc	Stainless steel, tramp impurities, and fission
^{110m} Ag	249.8 days	¹⁰⁹ Ag (n,) ^{110m} Ag	Silver-Indium-Cadmium Control rod wear, Helicoflex™ seals
¹²² Sb	2.72 days	¹²¹ Sb (n,) ¹²² Sb	Secondary start-up source
¹²⁴ Sb	60.20 days	¹²³ Sb (n,) ¹²⁴ Sb	Secondary start-up source, RCP bearings, impurities
¹²⁵ Sb	2.75 years	¹²⁵ Sn decay ¹²⁴ Sb (n,) ¹²⁵ Sb	Fuel cladding impurities and neutron capture by ¹²⁴ Sb
¹⁸¹ Hf	42.4 days	¹⁸⁰ Hf (n,) ¹⁸¹ Hf	Fuel cladding impurities
¹⁸⁷ W	23.9 hours	¹⁸⁶ W (n,) ¹⁸⁷ W	Stainless steel, carbides, and welding artefacts

3.1.3.1 Corrosion Product Transport and Activation

A series of events must occur before a given radionuclide can reach and incorporate into ex-core oxides. Hussey identified five steps in the process [1]; each of these steps is a complicated process that should be evaluated in more detail.

- 1) Corrosion product release from out-of-core surfaces.
- 2) Transport to the core and deposition on fuel cladding surfaces.
- 3) Activation of the corrosion product metal.
- 4) Release of the activated corrosion product from the fuel cladding surface and transport from the core.
- 5) Deposition or uptake of the corrosion product on out-of-core surfaces.

An exception to the 5 steps above relates to the release of radionuclides produced by activation of reactor vessel internals, fuel assemblies, and other fuel structure components. In this case, the basic steps are best described as:

- 1) Activation of fuel assembly or structural component metals.
- 2) Release of highly activated corrosion products in the coolant and transport from the core.
- 3) Deposition or uptake of the corrosion products on out-of-core surfaces.

Release of these corrosion products can be affected by processes such as dissolution, spalling, erosion, and corrosion while deposition is driven by diffusion, inertia (the ability to maintain a particle in solution), temperature gradient, surface charge, etc. Plant design, flow, and chemistry play an integral role in the corrosion and corrosion release rate process. Primary coolant chemistry (pH_T, Zn and H₂ as well as local velocity (wall shear forces) and temperature are important factors to consider related to the management of corrosion products.

Equation 4 captures the basic processes activated corrosion products undergo after release from core surfaces. The concern for radiation protection is the uptake terms in Equation 4. These terms (KAC) for stainless steel and SG tubing are dependent on maturity of material (oxides), temperature, porosity of the oxides, and the thermal conditions. Numerous research projects have reviewed and defined the corrosion and corrosion product releases of piping surfaces and alloys in the primary circuit. In order to impact the source term, one must change the corrosion rate of the alloys, change the corrosion product release mechanisms or alter the uptake terms.

$$\text{Equation 4} \quad A_{coolant} = \frac{RR_{Fuel} - W_{LD}C - k_{SG}A_{SG}C - k_{SS}A_{SS}C}{M\lambda}$$

Where:

A	=	Activity
C	=	Primary circuit activity concentration, Bq/kg (μCi/kg)
RR	=	Release rate into the coolant, Bq/s (μCi/s)
M	=	Mass of the primary coolant, kg
λ	=	Decay constant, (s ⁻¹)
A _{SS}	=	Stainless steel area, (m ²)
k _{SG}	=	Steam generator tubing incorporation rate constant, (Bq/s)/(Bq/m ² /kg) (μCi/s)/(μCi m ² /kg)
k _{SS}	=	Stainless steel incorporation rate constant, (Bq/s)/(Bq/m ² /kg) (μCi/s)/(μCi m ² /kg)
W _{LD}	=	Let-down flow rate, (kg/s)
A _{SG}	=	Steam Generator area, (m ²)

The sections below capture some of the more common radionuclides of concern for radiation protection. It is not intended to be an all-inclusive, but a review of the major sources of activated corrosion products in more details compared to Table 2.

3.1.3.2 ⁵¹Cr

⁵¹Cr is formed as a result of neutron-gamma activation of ⁵⁰Cr (Equation 5) generated from corrosion of the primary circuit piping. ⁵¹Cr is observed in the primary circuit analysis and typically it is not a major contributor to the overall source term from a dose perspective. ⁵⁰Cr has a natural abundance of about 4%. The low energy gamma can be masked in the Compton continuum during analysis or gamma scans.

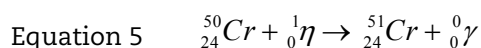

3.1.3.3 ${}^{54}\text{Mn}$

${}^{54}\text{Mn}$ is formed as a result of the high energy neutron-proton activation of ${}^{54}\text{Fe}$ (Equation 6). The source ${}^{54}\text{Fe}$, which is about 6% natural abundance, is primarily from the corrosion of primary circuit piping.

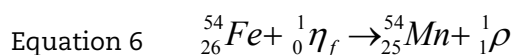

3.1.3.4 ${}^{58}\text{Co}$

${}^{58}\text{Co}$ is formed from the neutron-proton activation of ${}^{58}\text{Ni}$ (Equation 7). On decay, ${}^{58}\text{Co}$ emits multiple decay energies with the primary energy at ~811 keV. Nickel is a primary constituent in PWR Alloy 600 and 690 steam generator tubing and has in the past been used in some core components (grid straps).

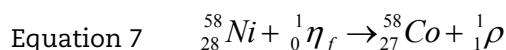

${}^{58}\text{Co}$ is the second largest source to consider for PWRs and can be a significant contributor to shut down radiation fields. In some cases, ${}^{58}\text{Co}$ may be the largest source for a particular outage because of large releases during end-of-cycle operation (over the last 200 days of operations).

3.1.3.5 ${}^{59}\text{Fe}$

${}^{59}\text{Fe}$ is formed as a result of a neutron-gamma activation of ${}^{58}\text{Fe}$ (Equation 8). ${}^{58}\text{Fe}$ is approximately 3% natural abundance and is primarily from the corrosion of primary circuit piping surfaces.

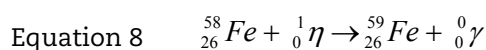

3.1.3.6 ${}^{60}\text{Co}$

${}^{60}\text{Co}$ is formed as a result of neutron-gamma activation of ${}^{59}\text{Co}$ (Equation 9). The decay of ${}^{60}\text{Co}$ presents two problems for plant personnel; the first is the relatively long half-life, and the second is the two high energy gammas emitted on decay.

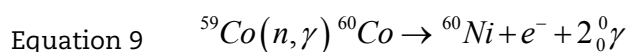

In general, system piping materials have very low cobalt content and minimising the cobalt content should always be a consideration when replacing components. Low cobalt replacement material should be considered in a plant's cobalt reduction programme.

3.1.3.7 ${}^{110\text{m}}\text{Ag}$

${}^{110\text{m}}\text{Ag}$ is formed as a result of neutron-gamma activation of ${}^{109}\text{Ag}$ (Equation 10). ${}^{110\text{m}}\text{Ag}$ has been observed in large amounts upon plant shutdown after oxygenation, significantly impacting let-down dose rates. The primary source for ${}^{110\text{m}}\text{Ag}$ is believed to

be from Ag-In-Cd control rod wear, although in some cases, an additional source could be silver from seal rings or soldering materials.

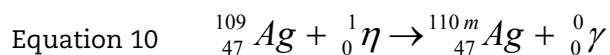

3.1.3.8 ^{122}Sb , ^{124}Sb , ^{125}Sb

Antimony has two stable isotopes, ^{121}Sb with an abundance of 57.36% and ^{123}Sb with an abundance of 42.64%. ^{121}Sb and ^{123}Sb are the source for the activation products ^{122}Sb and ^{124}Sb , respectively, through a neutron-gamma reaction (Equation 11 through Equation 13).

^{124}Sb is formed as a result of neutron-gamma activation of ^{123}Sb (Equation 12). Secondary start-up sources composed of antimony-beryllium encased with a stainless steel cladding have in the past lead to significant shutdown dose issues on failure. Antimony-impregnated graphite pump seals and bearings have also been sources of radio antimony. Several utilities have replaced these sources on a more aggressive schedule or removed the start-up sources from the plant.

The longest-lived isotope is ^{125}Sb with a 2.75 year half-life, which is formed through decay of ^{125}Sn and neutron activation of ^{124}Sb . ^{125}Sb is formed as a result of neutron-gamma activation of ^{124}Sn (~5.8% of natural tin). Equation 13 captures the activation step to ^{125}Sb , and the subsequent beta decay to ^{125}Sb . The source of tin is believed to be from the fuel cladding where tin is a minor constituent of Zircaloy and ZIRLO™.

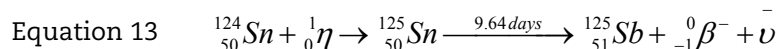
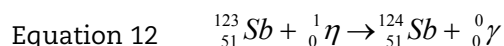
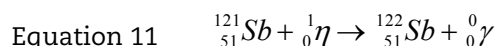

3.1.3.9 Conclusion

Sections 3.1.3.2 through 3.1.3.8 capture only a few of the many activated corrosion products that can impact the overall radiation fields. A comprehensive source-term reduction programme evaluating replacement material and the impacts to radiation fields is critical to the long-term success of source-term reduction programmes.

3.1.4 Contribution of radionuclides to dose rate

The radiological impact of radionuclides with short radioactive half-lives such as ^{16}N (7.3 seconds) is extremely high during operations related to containment or drywell entries, but become negligible within a few minutes after shutdown due to the rapid decay. The overall contribution of these short-lived radionuclides to the refuelling outage radiation field is negligible.

As previously noted, fission products represent the largest source of radionuclides within the primary circuit, but have limited impact on radiation fields. However, unless significant fuel defects (number, size, or combination) are present, the fission products are contained within the fuel assemblies and do not contribute to the overall radiation field that the workers are exposed to during operation or maintenance activities. Refuelling operators are shielded from the very high and intense radiation fields from the

fuel assembly by the refuelling pool water and distance. Considering the coolant activation products and shielding to refuelling operators, the most important radionuclides with respect to worker dose are the activated corrosion products ^{60}Co , ^{58}Co , potentially $^{110\text{m}}\text{Ag}$ and ^{124}Sb , and ^{95}Zr and ^{95}Nb in PHWRs.

In case of specific contamination, $^{110\text{m}}\text{Ag}$ and ^{124}Sb can strongly contribute to dose rates. These four radionuclides are particularly bothersome during outage work and significant/major contributors to ex-core dose rates. Table 3 provides a summary of the main radionuclides of concern, their fission and activation products and sources.

Table 3: Source terms components – Summary table

	Fission Products	Activation Products	Actinides or heavy nuclei
Production Methodology	Generated by nuclear fission under neutron flux into fuel rods during operation	All material near reactor core is activated: hard structures ² but mainly corrosion products transported by primary coolant	Constituents of fission (uranium or plutonium) splitting during operation to provide energy
Dominant Radionuclides	^{131}I , ^{133}Xe , ^{85}Kr , ^{134}Cs , ^{137}Cs	^{60}Co , ^{58}Co , $^{110\text{m}}\text{Ag}$, ^{124}Sb , ^{54}Mn , ^{59}Fe	^{239}Pu , ^{240}Pu , ^{241}Am , ^{242}Cm , ^{244}Cm
Impact	Operation	Corrosion products are transported into the reactor and auxiliary systems subject to deposition or incorporation onto wall pipe surfaces. ^{16}N is present in the reactor water ^{41}Ar is present in the ventilation air (mainly for PWRs) or leaked in air (mainly for BWRs)	Confined to the fuel rod cladding, actinides can spread in primary circuit in case of severe cladding defect.
	Maintenance Outage Operations	An activity peak may be observed during plant depressurisation activities in case of cladding defects.	These activated corrosion products are the largest contributor to shutdown dose rates. If the recommended procedures are followed, the contribution to worker doses will be minimal.
			Generally absent from primary coolant except in case of severe cladding defect occurring during previous cycles or impurities from manufacturing.

In general terms, actinides and fission products do not pose problems regarding dose rates, but can be an issue if the primary system is opened and the plant has a history of fuel cladding failures. As a conclusion, the impact of the activation products (mainly corrosion products) will be the main focus of this report.

3.2 Material Issues

Nuclear steam supply systems (NSSS) are constructed from alloys based on several factors supporting the plant life cycle. These materials fulfil several requirements including material integrity, wear resistance, satisfactory corrosion behaviour, and low

2. All materials inside the reactor vessel (e.g. internals, fuel cladding and materials of construction) should be considered and understood regarding their source-term impact. Piping penetrations and concrete have many other factors to consider related to long-term maintenance activities and decommissioning activities (i.e. ^{36}Cl)

activation in the expected environment. From a radiation protection and dose rate point of view, the most important material issue is the corrosion resistance of the material. Regardless of NSSS design, alloys corrode when in contact with high temperature water or steam environments. This in turn results in the release of corrosion products, which are then available for deposition and activation. As an example, the PWR fleet is challenged by the high surface areas of the Alloy 600, 690, and 800 tubes used in the steam generators.

3.2.1 Pressurised Water Reactors (PWRs)

For PWR's, ^{58}Co and ^{60}Co are the significant contributors to shutdown radiation fields. Other radionuclides present contributing to radiation fields may include $^{110\text{m}}\text{Ag}$, ^{122}Sb , and ^{124}Sb . In general terms, the primary radiation field contributors are ^{58}Co and ^{60}Co . Table 4 gives an overview of typical PWR materials showing a mixture of stainless steels and alloys.

Table 4: Typical PWR materials of construction

Component(s)	Material
Primary Circuit – Reactor Vessel and Piping	
Vessel Cladding	304 SS (Weld Deposited)
Vessel Internals	304 SS
Instrument and Control Rod Drive Nozzles	Alloy 600
Control Rod Drives	304 SS and 410 SS
RCS Piping	304L SS
Surge and Spray Piping	316 SS
Steam Generator	
Bottom Head Cladding	304 SS (Weld Deposited)
Tube Sheet Cladding	Alloy 600 (Weld Deposited)
Tubes	Alloy 600, 690, or 800
Divider Plate	410 SS
Pumps	
Casing	316 SS
Internals	304 SS
Pressuriser	
Cladding	304 SS and / or Alloy 600
Heaters	304 SS and / or Alloy 600

3.2.1.1 Steam Generator Material

The primary side of the SG consists of tubes made of Alloy 600, 690, or 800 and represents the largest surface area in the primary circuit, and the principle source for ^{58}Ni . The corrosion and release rates of Fe, Ni, Cr, Co and other elements from the SG tubes will have a major effect on the subsequent formation of activated corrosion products. Plants that have replaced Alloy 600 tubes with Alloy 690 should observe a reduction in corrosion and corrosion release rates over time. Laboratory data suggests as much as a factor of three reductions in corrosion may be observed for Alloy 690 tubing compared to Alloy 600 tubing. [2]

3.2.1.1.1 Steam Generator Manufacturing Process

Various manufacturing steps have been considered in an effort to understand the impact on passivation and related to corrosion and corrosion product release. There have been a number of improvements to the manufacturing of Alloy 690 tubes since the initial deployment. The manufacturing processes modified include the sandblasting of tubes with corundum particles has been suppressed, the annealing process is now under H_2

compared to the earlier options of NH_3 or H_2 . The carbon content has been reduced and the equivalent carbon content is taken into account for determining the annealing temperature. Pilgering steps and/or drawing have been optimised, cleanings has been introduced, cleaning baths have been modified etc. Accordingly with these manufacturing process optimisations, the improvements are expected to result in enhanced corrosion product behaviour and subsequent corrosion product release.

The French fleet has conducted extensive research in this area. In French reactors, four main periods can be considered according to the optimised processes. The first period is for SG manufacturing through 1988, the second is the period from 1989–1992, the third is the period from 1993–1995, and the fourth is SG manufacturing after 1995 [3, 4]. In Figure 2, the evolution of ^{58}Co peak deposited activity on hot legs over cycles for various French reactors are presented for the 900 MWe series of reactors. Figure 3 is for EDF 900 MWe fleet and shows the evaluation of ^{58}Co oxygenation peaks. Both figures represent the evaluation ^{58}Co post-steam generator replacement. It should be noted that EDF follows a standardised chemistry programme for the various fleets and only minor modifications related to the shutdown procedure have occurred over this period. These modifications should have a minor impact on oxygenation peaks, if any. Based on the EDF data, variations observed in ^{58}Co peaks between the different series appear to be mainly due to manufacturing processes, surface condition, and eventual surface preconditioning.

Figure 2: EDF 900 MWe Fleet ^{58}Co deposited activity on hot legs over cycles

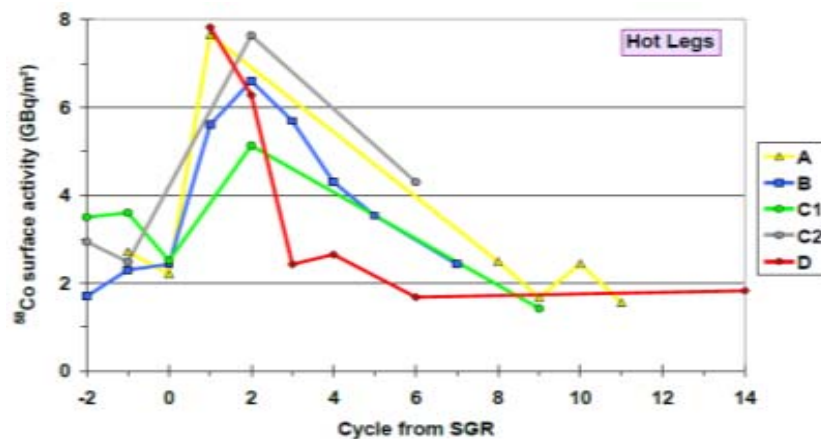
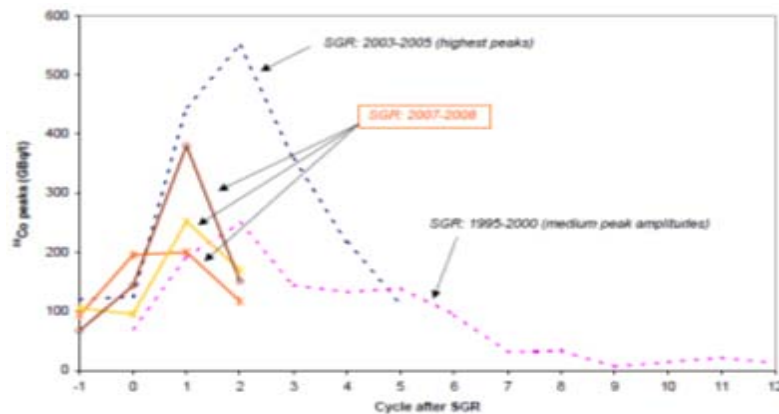

Figure 3: EDF 900 MWe Fleet ^{58}Co oxygenation peaks



The kinetic results and the characterisation of the surface state and the oxide layers formed on the surfaces show that corrosion product release is a complex phenomenon. The surface state has a great influence on the release rate but the effects are not easy to summarise and are beyond the scope of this paper.

Figure 4 represents approximately 200 cycles of additional ^{58}Co data from across the fleet representing plants injecting zinc and not injecting zinc, higher pH programmes to lower pH programmes, and plants using speciality resins and enhanced clean-up systems. As shown in the figure, the ^{58}Co peaks approximately 3–5 cycles post-SGR and trends to lower levels over time. The peaks reach a minimal concentration between 8 and 12 SG effective full power years.

Figure 4: Post-steam generator replacement of ^{58}Co peaks ($\mu\text{Ci/g}$)

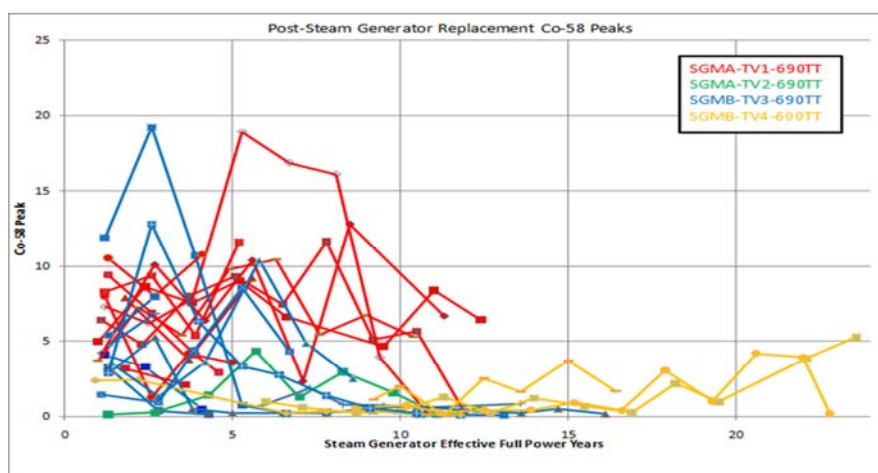

3.2.1.2 Primary Circuit and Other Components (Non-SG)

Primary system piping in PWRs (reactor coolant, RHR, and the Chemical and Volume Control System or CVCS) is primarily composed of stainless steels and is exposed to high pressure and temperature environments. The environmental conditions vary from acidic to alkaline conditions under reducing or oxidising. See Appendix-1 table 1 which includes information on primary PWR materials.

3.2.1.3 Other Systems or Components

3.2.1.3.1 Cobalt Sources

Early plant designs applied a high cobalt alloy material supporting long-term wear resistance and component or equipment reliability. These components contained Stellite™ for the hard facing surfaces and other reactor internals (BWR Control Blade roller bearings, etc.) where identified as the primary source of ^{59}Co which undergoes neutron capture and activates to ^{60}Co . These activated species migrate to ex-core surfaces and can deposit through a several mechanisms on piping surfaces, thereby contributing to the overall radiation fields workers are exposed to during operations and maintenance activities.

Utilities have developed various processes to address and minimise the amount of cobalt material placed in-service. These efforts continue to show benefit and have reduced the overall source term due to component replacement. It has been demonstrated that numerous cobalt-free alloys with appropriate characteristics are available to replace the cobalt-based alloys previously used as hard facing materials. Cobalt-free or reduced cobalt materials have undergone extensive testing programmes

and are now being introduced and used with increasing frequency in numerous applications throughout the industry with acceptable results. Also, a structural alloy with good wear resistance such as 400 grade stainless steel may be used in some applications where a cobalt-base hard facing alloy previously had been used. Controlling the cobalt impurity level in structural alloys used for initial procurement and in replacement components is discussed in the EPRI Radiation Field Control Manual TR-1003390 [5].

Revision 1 of the EPRI Cobalt Reduction Sourcebook identified several tables and the composition of several commonly applied materials in the PWR fleet [6]. See Appendix-1, Table 2 and 3 for example of hard faced cobalt materials composition and examples of hard faced nickel material composition.

Each station should have cobalt reduction guidance documents developed to address cobalt source term reduction efforts and processes. The EPRI Cobalt Reduction Sourcebook provides example flowcharts that utilities can apply in the identification of appropriate action plans.

3.2.1.3.2 Fuel Support Material

Early fuel assemblies in the fleet used stainless steel fuel cladding with Inconel™ grids. These grids were not only high in nickel content, but high in residual cobalt content. The resulting impact was high coolant radionuclide concentrations and transport to ex-core surfaces, which resulted in higher plant dose rates. The fuel vendors replaced this material with a zirconium-based material, resulting in a significant reduction in ⁵⁸Co and ⁶⁰Co levels. In general terms, western-style PWRs have replaced all of the high nickel and cobalt content fuel assembly materials of construction with low-cobalt, zirconium-based alloys. Table 5 list example materials of fuel assembly construction.

Table 5: Example Modern PWR Fuel Assembly Materials of Construction

Component	Example Materials of Construction
Fuel cladding material	Example: M5™ ³ or Zirlo™
Spacer grids	8 x grids with M5 straps and Inconel™ springs
Upper end fittings	AISI 304L with Inconel™ springs + spring screw and AISI 308 lock pins
Lower end fitting	AISI 304L with AISI 660 anti-debris device and AISI 304 pins
Guide tubes	Example: M5™ or Zirlo™
Grid spacer spring strip	Inconel™ springs

Western style PWRs require boron for reactivity control in the primary coolant, but rod control cluster assemblies (RCCA) ensure sufficient negative reactivity to ensure the reactor shutdown margin is maintained. The neutron absorbing material is hafnium, or a silver (80%), indium (15%), and cadmium (5%) alloy. ¹⁰⁹Ag is produced from RCCA rod wear and is the source for ^{110m}Ag. It should be noted that silver may also originate from seal rings. Based on EDF data, the amount of metallic silver contamination is estimated to be from 1 to 10 grams and contributes significantly to the dose rate in the shutdown cooling and clean-up systems.

^{110m}Ag contamination can significantly impact dose rates in the shutdown cooling system, clean-up system heat exchangers, and downstream components to the clean-up system due to precipitation.

- Inconel is the registered trademark of Special Metals Corporation referring to group of austenitic nickel-chromium-based superalloy.

3.2.2 Water-Water Energetic Reactors (VVERs)

VVER type reactors represent a separate group of PWRs. Within Europe, two main types of reactors are operated; VVER-440 and VVER-1000. There are several significant differences between VVERs and PWRs that significantly influence the dose rate build-up processes, as described further and in chapter 3.3.2.

3.2.2.1 Steam generator materials

All of the primary circuit of a VVER-440 is made of stabilised austenitic stainless steel 08CH18N10T (AISI 321); for VVER-1000 units, the situation is very similar except that the SG collectors are made of perlitic 10GN2MFA (10NiMo8 5) steel. The VVER SG materials of construction contain significantly less nickel compared to their western-style PWR counterparts. This results in much lower ⁵⁸Co concentrations and simpler shutdown chemistry.

The steam generators are of horizontal design and this fact has special importance, especially in the decontamination processes. For VVER-440 type units, the steam generators are employed for RHR operation during shutdown/refuelling.

3.2.2.2 Cobalt inventory

VVER reactors are typically very low cobalt plants; with the exception of the Loviisa plant, no Stellite™ components are used in the primary and auxiliary systems. The cobalt content of the SG tubes material is typically less than 50 ppm, so there little ⁶⁰Co produced. At NPP Loviisa, presence of Stellite™ components lead to significant growth of dose rates at the cold legs of the primary loop in the 1980s and full system decontamination was performed at Loviisa Unit 2. Programme for gradual replacement of Stellite™ materials was implemented.

3.2.2.3 Surface preconditioning

There are no specific methods applied for surface preconditioning during manufacturing processes, only HFT passivation is performed during plant commissioning.

3.2.2.4 Fuel support material

VVER fuel metallic structures are made of Russian E110 alloy (Zr+1%Nb) with very low impurity content. The fuel assembly head and bottom nozzle are constructed from AISI 321 steel; in the 1990s the spacer grids were made of AISI 321 steel and later replaced by E110. This replacement brought a corresponding reduction of radiation fields due to the removal of one important Co source.

VVER units typically operate with a 12 month fuel cycles with moderate fuel duty. On-going duty increases within power uprating and fuel burn-up extension projects are being introduced at many plants, extended cycle lengths are now also considered by some operators.

3.2.3 Pressurised Heavy Water Reactors (PHWRs)

While the NSSS of PHWRs resembles that of a PWR, the core design is significantly different (nuclear fuel contained in pressure tubes, use of natural U as the fuel, separate moderator system) which results in significant differences in activity transport. Activity transport in the CANDU primary heat transport system (HTS) involves the release; activation and deposition of corrosion products present as particulate (including colloids)

or dissolved species [Guzonas 2004, 2006, 2010]. In addition to corrosion, wear of various system components, such as pump seals, valve hard facings, bearings, and material released by the movement of fuel along pressure tube surfaces during refuelling, can release particulate material into the coolant. These wear products can be major contributors to activity transport in PHWR reactors. Once released into the coolant, the transport of both inactive parent and active corrosion or wear products can potentially involve many phases (e.g., particles or dissolved species in the coolant, deposits on surfaces) and processes (e.g., dissolution, precipitation, adsorption) before activated species are finally deposited on out-core surfaces.

Two limiting cases with respect to surface area and impurity concentration are important in the PHWR HTS:

1. High surface area materials with trace concentrations of an impurity – e.g., steam generator tubes and feeder pipes with ppm concentrations of Co.
2. Low surface area materials with high concentrations of an impurity – e.g., Stellite™ valve hard facings or fuelling machine load balls in which Co is a major constituent of the alloy.

The use of a relatively high surface area of carbon steel piping (inlet and outlet feeder pipes)

In addition, magnetite deposition in the SGs enables them to act as ‘full-flow’ purification ion exchangers, removing a significant fraction of both activated species (e.g., ⁶⁰Co) and the inactive parent (e.g., ⁵⁹Co). By removing nickel [Burrill and Guzonas] it also minimises the deposition of nickel phases in the core and the production of ⁵⁸Co.

3.2.3.1 Cobalt inventory

The PHWR design is unique in its ability to refuel on-line, using a pair of fuelling machines able to move across the reactor face and attach to the opposite ends of the specific fuel channel to be refuelled, while the reactor is operating. The main components of the fuelling machine ram are 4 ball screws that contain Stellite™ Star-J load balls (36 wt.% cobalt). Measurements of the reduction in the ball diameters suggest that wear and/or corrosion of these balls can release a significant mass (on the order of grams) of ⁵⁹Co into the fuelling machine circuit. These wear products are mixed into the fuelling machine water and are either removed by the purification filters in the fuelling system or injected into the HTS during fuelling [Guzonas, 2006].

The fuelling machine purification circuit filters are expected to remove wear particles, the effectiveness depending on both the particle size and the pore size of the filters. Recent data [Gauthier and Guzonas] suggests that some of the Co released from the load balls is present as a charged species (dissolved or colloidal) that can only be removed by ion exchange resins. Therefore, both the fuelling machine purification system filters and ion exchange resins must be effective in removing ⁵⁹Co from the coolant serving the fuelling machines.

3.2.4 Boiling Water Reactors (BWRs)

The BWR fleet contains a number of components with elemental cobalt (⁵⁹Co) present. This includes many of the steam to power conversion systems (main steam, feed water, condensate and heater drains, etc.) and the associated valves in the systems. Many of the valves were originally installed with Stellite™ on wear or load bearing components. The challenge with Stellite™ and the amount applied in the BWR fleet is the large weight percentage of ⁵⁹Co present (50 – 60%) and in some cases the large surface areas with Stellite™. In addition to valves, other major components were designed with Stellite™ including, but not limited to, the jet pumps and control rod blades. Early designed units

did not specify low cobalt applications and as such, resulted in a large source of ^{59}Co that was released to the coolant from corrosion and other processes. This led to and continues to represent a large source of elemental cobalt that is activated to ^{60}Co . Many of these early designed plants have replaced these components and continue to show the benefits of a lower ^{59}Co source term.

3.2.5 Material and Technology options

Section 3.2.5 provides a general overview of options related to materials preconditioning and improvements that may be applied to aid in the minimization of corrosion products released and subsequently activated.

3.2.5.1 Electropolishing

Electropolishing (EP) is the electrochemical removal of microscopic irregularities from metal surfaces. The process involves the controlled anodic dissolution of metallic surfaces using an electrolyte and a cathode suitably shaped to accommodate the geometry of the component. This process has been applied to BWR and PWR primary systems including replacement piping RWCU spools, steam generator man way seals, and steam generator channel heads. The application of this technology has demonstrated a great reduction in activity uptake and reduced dose rates.

3.2.5.2 Stabilised Chromium Process (SCrP)

SCrP was developed and patented by the Electric Power Research Institute (EPRI) and works by the application of thin films of electroplated chromium followed by preoxidation in moist air. The process has been shown to significantly reduce activity pickup when applied to the surfaces of replacement components [5, 7]. The surface conditioning method has been applied to reactor water clean-up piping (RWCU) and Jet Pumps in BWRs and steam generator man way covers in PWRs for example reducing activity uptake on those components and reducing dose rates fields in those areas of the plant.

3.2.5.3 Technology - Surface preconditioning

Corrosion product release is a complex phenomenon. The surface state has a great influence on the release rate, but it is not easy to describe and to quantify the impact of the surface parameters. In the case of SG tubing, preconditioning oxidation can be potentially performed by two processes; factory preconditioning and onsite conditioning.

The first step is to perform a surface treatment at the manufacturing facility as part of the original manufacturing process. The second step is through preconditioning after installation. In general terms, this surface preconditioning corresponds to a preconditioning phase during the plant start-up (similar to hot functional tests). Regarding this second step, R&D experience indicates that pre-oxidation under basic and reducing conditions at high temperature is the most effective environment during hot functional tests. However, EDF has on-going studies in this area [8, 9].

It has been demonstrated that in pure primary water, the release phenomenon was controlled by the rate of formation and growth of the oxide scale, in particular the inner oxide film enriched in chromium. The outer oxide layer, formed mainly by thermochemical and diffusion mechanisms, is generally made of nickel oxide (NiO) or a phase with the spinel structure (such as nickel ferrite NiFe_2O_4) (Figure 5).

Figure 5: Schematic representation of the oxide grown in high temperature primary water on tubes made of alloy 690TT

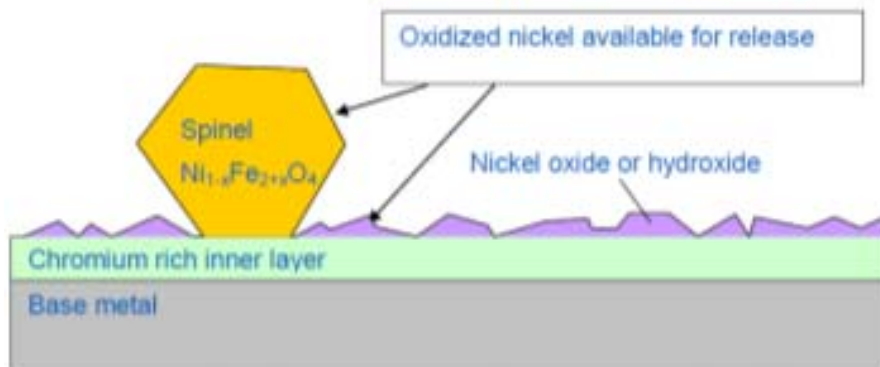

Even if significant differences in the oxidation behaviour of alloy 690TT tubes are observed, it seems to be a common feature that the oxidation rates are strongly reduced after passivation, which is a shorter timescale than the observed reduction in ^{58}Co oxygenation peaks. In the early cycles of operation, a significant fraction of the nickel would be released during the first cycles of operation.

EDF research has shown that oxidation occurs rapidly on initial exposure to water and higher temperatures. This provides an opportunity to remove a large inventory of nickel before reactor operations, thereby minimising the formation of activated ^{58}Co . The first step is to dissolve the nickel from the outer oxide with the help of the protective inner oxide, and then remove it from water with the help of purification systems like the Chemical and Volume Control System (CVCS). To do this within a relatively short time, it is required that nickel concentrations in the $\text{mg}\cdot\text{kg}^{-1}$ range or higher are attained. By examining the available data on the solubility and dissolution kinetics of the possible nickel containing solid phases, EDF has found that the best compromise within chemical specifications is a temperature around 170°C , an acidic pH and a hydrogen concentration between 10 and $30\text{ cc}\cdot\text{kg}^{-1}$ range or higher. This kind of pre-oxidation and cleaning procedure was rolled out by EDF on a French NPP in 2011 but did not seem to be as efficient as expected [10].

3.2.5.4 Component Preconditioning

Preconditioning of the surfaces of replacement components can significantly reduce recontamination rates, as well as reduce the cobalt release rate. The nature of primary component surfaces affects the ability of the passive oxides that form on them to incorporate the activated corrosion products, primarily ^{60}Co , ^{58}Co , and ^{65}Zn , that are responsible for occupational radiation exposure. Surface roughness, surface chemistry, and even surface residual stresses play a role in determining the amount of activity pickup. It was recognised early that electropolishing might lower activity pickup simply by reducing the total surface area in contact with the primary coolant. Another approach to reducing the build-up of radioactivity is to effectively film or coat components that contact the primary coolant. Such coatings could serve two main functions: [2] they form a diffusion barrier against the outward migration of cobalt that is present as an impurity in reactor construction materials, which is desired because the release of cobalt to the coolant is the first step leading to its activation, and [2] coatings may render the surface less susceptible to the incorporation of radioisotopes following their formation in the reactor core. Replacement of primary system components affords utilities an opportunity to specify a surface treatment that is designed to lower the incorporation of activated corrosion products.

Comprehensive programmes to develop effective preconditioning techniques have been successful, and the two most widely used surface modification techniques now used in nuclear power plants are electropolishing (EP) and a chromium coating and passivation technique that is designated the Stabilised Chromium Process (SCrP).

3.2.5.5 Other Preconditioning Methods

Recently a new method has been developed by Sumitomo Metals for the formation of a chromium rich surface oxide layer on Alloy 690 steam generator tubes. In laboratory testing this material has demonstrated reduced release of nickel when exposed to simulated PWR environments for up to 1.000 hrs. The coating has also been applied to Feedwater Heater Tubes in the Higashidori BWR [11].

3.2.5.6 Technology – Preventive filtration with specific devices

The simplified diagram below illustrates the principles of the preventive filtration methods, which are proposed (Figure 6). It consists of the filtration of all the effluents, which could transport hot spots outside the reactor building.

The drains of pools and the primary circuit are important routes for the development of hot spots and the transfer of material that will settle in low flow areas, contributing to the build-up of hot spots. The installation of fine filters or an initial barrier is proposed for the drain orifices of each pool. The drain lines of the primary cooling circuit represent the second transport mechanism of hot spot migration. This process enables both draining processes to be treated with the same device.

Figure 6: Preventive filtration methods

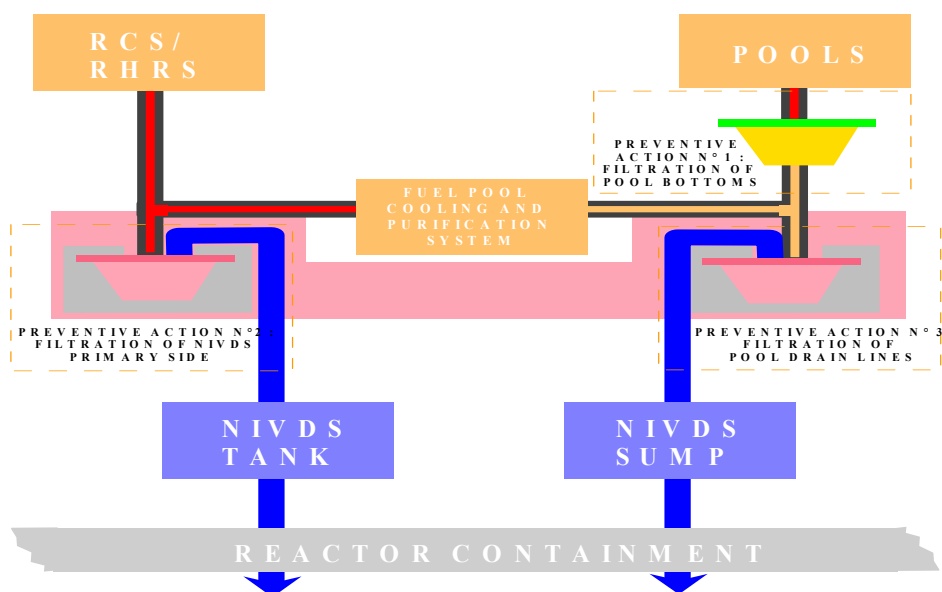

These modifications are a strategic decision related to the spread of hot spot contamination outside of the reactor building. However, it is a complicated design modification process with regulatory requirements.

3.2.6 Materials Overview Preventive Strategies

Cobalt reduction programmes are essential to the long term source term management. Section 3.2.1 provides some information related to key discussions. The understanding and application of technologies can significantly impact source term over several cycles. Some key aspects of a good programme include:

- Identification of the overall cobalt source term.
- Establishment of a Cobalt Reduction Programme.
 - Including the limited usage of cobalt based components.
 - Optimisation processes to remove existing materials and understanding methodologies for clean-up following maintenance activities.

Surveillance programmes are designed to alert the site as early as possible to the presence of hot spots (mapping) in order to take the appropriate measures to prevent their propagation and/or to eradicate them. During unit operation, most hot spots will remain fixed to the fuel. Others may fall, by gravity, to the bottom of the pool or the low points of the primary coolant system or be trapped in the special devices. The most common locations are as follows:

- Thermal sleeves of nozzles of the boiler,
- Valves of the primary cooling system, etc.

3.3 Overview of available chemical methods

3.3.1 Purification/Clean-up System Basics

Each NSSS design has clean-up systems that were originally designed to maintain coolant impurity concentrations within specifications and fission product activity levels supporting off-site dose calculations during accident conditions. Each of the PWRs has basically the same design for clean-up systems. The names for the systems or components vary slightly across the fleet, but in general the systems support five basic functions:

1. Maintain the programmed water level in the pressuriser that in turn maintains the required water inventory in the RCS.
2. Provide operators with the ability to fill and drain the RCS or during outage and after maintenance conditions pressure-testing of the RCS.
3. Provide the flow to the RCS during safety injection conditions.
4. Control RCS chemistry including activities per design basis documentation, the chemical neutron absorber (boron) and makeup impurities to the RCS.
5. Maintain seal water injection to the reactor coolant pumps.

In the case of the Westinghouse designs, there are three sections or branches of the system: charging, seal water and letdown. During normal operations the plant maintains a continuous flow or feed to the RCS via the charging segment of the system. This flow path is typically charging water back into the RCS and seal injection systems. The primary source of water or at least early in the cycle is recycled coolant from letdown that has passed through a makeup tank covered with hydrogen gas and from seal leak-off. Related to seal injection, a significant amount of this water is routed back to the charging section and the balance is added to the RCS combined with charging flow matched to let-down flow to maintain pressuriser level.

Given the demands placed on plant personnel to reduce the overall source-term, plant personnel and research institutes have expended significant efforts to optimise these systems. Resin vendors continue to improve resin performance in efforts to increase the removal efficiencies of different species.

In order to understand the limitations of clean-up systems, a basic background on clean-up calculations is required. The effect of clean-up flow to system volume and efficiency are variables that can provide insight into the impact of changes related to resins, flow and volumes. Equation 14 provides the basis for the discussions in Section 3.3.1.

$$\begin{aligned}
 N(t) &= e^C e^{-\lambda t} = N_o e^{-\lambda t} \\
 N_f &= N_i e^{-\lambda t} \\
 \text{Equation 14} \quad & \text{OR More Commonly :} \\
 A_f &= A_i e^{-\lambda t}
 \end{aligned}$$

Where:

$A_{(f)}$	=	Final Activity concentration
$A_{(i)}$	=	Initial Activity concentration
λ	=	Decay constant ($\ln(2)/t_{1/2}$), s^{-1}
t	=	Time delta

3.3.1.1 Clean-up System Impacts

There are two key areas to consider related to clean-up systems. The first is the impact of clean-up systems during operations and second is the impact during outages for refuelling or maintenance. The impact during refuelling operations is critical and can significantly impact critical path clean-up times, which in turn, if activity is not cleaned up to outage goals may impact worker dose, while the impact during operations and limitations of the system related to the overall impact on source-term requires much more detailed evaluations including the effects of materials and fuel design.

During refuelling operations, a simple analogy is that the system has a fixed volume to consider based on the rapid releases observed during shutdown and cool down or in the case of the BWR fleet, the ^{60}Co release observed during the refuelling pool flood-up. Both present different demands on the clean-up system performance.

The equations that determine the clean-up system performance impact include system mass, system let-down and clean-up efficiencies. System mass and let-down are easily defined and recorded on many plant computer applications. Clean-up efficiency is simply determined based on the decontamination factor (DF) and defined below in Equation 15. As shown in Equation 15, there can be different DFs for different radioactive species depending on the resin and filtration removal capabilities. This requires an understanding of the efficiencies related to purification system operations.

$$\begin{aligned}
 DF &= \frac{\text{Activity}_{\text{Influent}}}{\text{Activity}_{\text{Effluent}}} \\
 \text{Equation 15} \quad & \text{And Efficiency is :} \\
 \text{Eff}(\%) &= \frac{DF - 1}{DF}
 \end{aligned}$$

Equation 15 can then be used in Equation 16 to calculate the purification constant considering the impact of clean-up flow, mass and efficiency.

$$\text{Equation 16} \quad \beta = \frac{((Ltdn_{gpm} * \rho_{ltdn}))}{\left(\left(\left(V * \rho_{RCS}\right) * 60 \frac{\text{sec}}{\text{min}}\right)\right)} * \frac{DF - 1}{DF}$$

Where:

$Ltdn_{gpm}$	=	Letdown, m ³ /sec (gpm)
ρ_{ltdn}	=	Letdown Density,
V	=	Coolant Volume, m ³ (gallons)
ρ_{RCS}	=	RCS Density
DF	=	Decontamination Factor
$DF-1/DF$	=	Removal efficiency for a specific isotope

In order to evaluate the overall effect, an effective half-life must be determined considering both the decay constant and purification half-life (Equation 17).

$$\text{Equation 17} \quad T_{Eff} = \frac{\ln(2)}{(\lambda + \beta)}$$

Where:

λ	=	Isotopic Decay Constant, s ⁻¹
β	=	Purification Constant, s ⁻¹

Equation 18 now can be used to obtain the effective half-life. As expected, and with the exception of short-lived radioisotopes, the isotopic decay term has little effect on the overall removal rate for power plants during shutdown activities.

$$\text{Equation 18} \quad A_f = A_i e^{-\lambda t}$$

Where:

$$\lambda = \frac{\ln(2)}{T_{Effective}}$$

Figure 7 simply compares the different effective half-lives using the equations above assuming 100% impurity removal by the resin and filters. As expected, with the exception of short-lived isotopes, the higher purification flows improves the purification half-life. This discussion is expanded in the following sections.

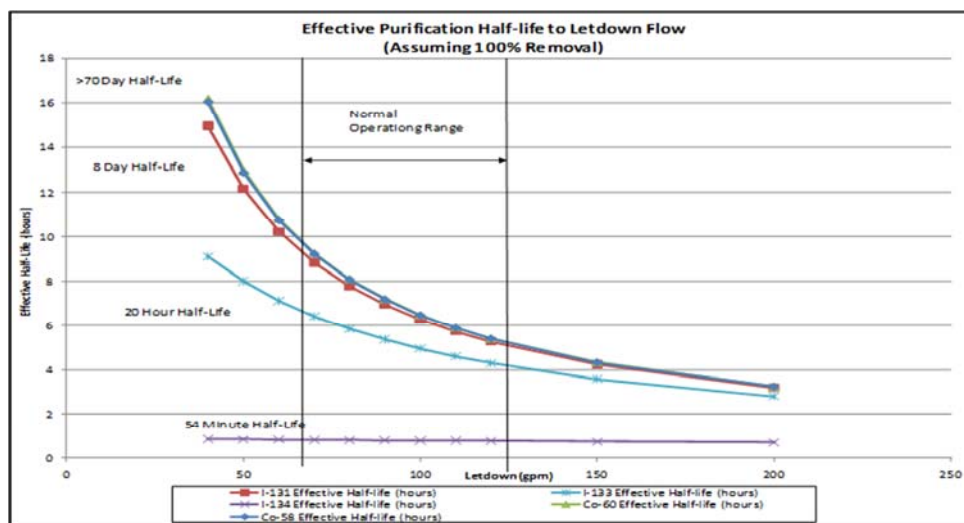
Figure 7: Half-life Impact on Purification Half-life

These basic principles provide an understanding of the factors impacting system clean-up and can be used in the evaluation of different technologies recognising that as resin efficiencies improve, the limiting factor in the clean-up system performance may be due to physical design limitations.

3.3.1.2 Clean-up System Resins and Filters

Using the equations described above, one can calculate the effects and/or limitations of clean-up systems on corrosion products and other impurities. Figure 7 assumed 100% efficiency and Section 3.3.1.2 expands the discussion related to various improvements over time. It should be noted that ^{58}Co is used only as an example, and the efficiencies for specific radionuclides should be considered.

3.3.1.2.1 Clean-up Flow Path

In general, the clean-up flow path is as follows. Hot water from the primary circuit is passed through one or more heat exchangers to the resin and filters. Piping size and length is designed to allow for the decay of ^{16}N or other short-lived radionuclides. The water ultimately reaches the clean-up demineralisers and filters. In some NSSS designs, filters are placed in front of the demineralisers and after the demineralisers. The filters allow for removal of particulates depending on the filter rating. The outlet filter was originally designed to remove resin fines, not for corrosion product management. In many cases, plants use sub-micron filters on the demineraliser outlet to aid in corrosion product management. The resins are designed to remove ionic impurities and combined with the filters optimise clean-up system performance. The purified coolant is then returned to the primary circuit.

3.3.1.2.2 Clean-up Resins

Resin vendors continuously try to improve resin removal efficiency for all isotopes of concern. Resins may be designed to remove specific radionuclides or to have improved removal of all impurities. The application of macro-porous resins and other speciality resins has been identified in improvements in overall source-term reduction strategies. The challenge for plant personnel is to identify all the factors related to source-term management and the impact of these strategies on the overall source-term.

Figure 8 shows the effect of increasing resin efficiency on purification half-life. As shown, increasing the resin efficiency from 75% to ~95% has a significant effect on the effective purification half-life while increasing efficiencies from ~95% to 100% has little effect on the rate of clean-up. Depending on the state of the isotope, almost all conventional gel resins, macroporous resins and engineered surface modified resins have improved removal efficiencies for ^{58}Co and ^{60}Co .

Figure 8: Resin Efficiency Impact on Purification Half-life

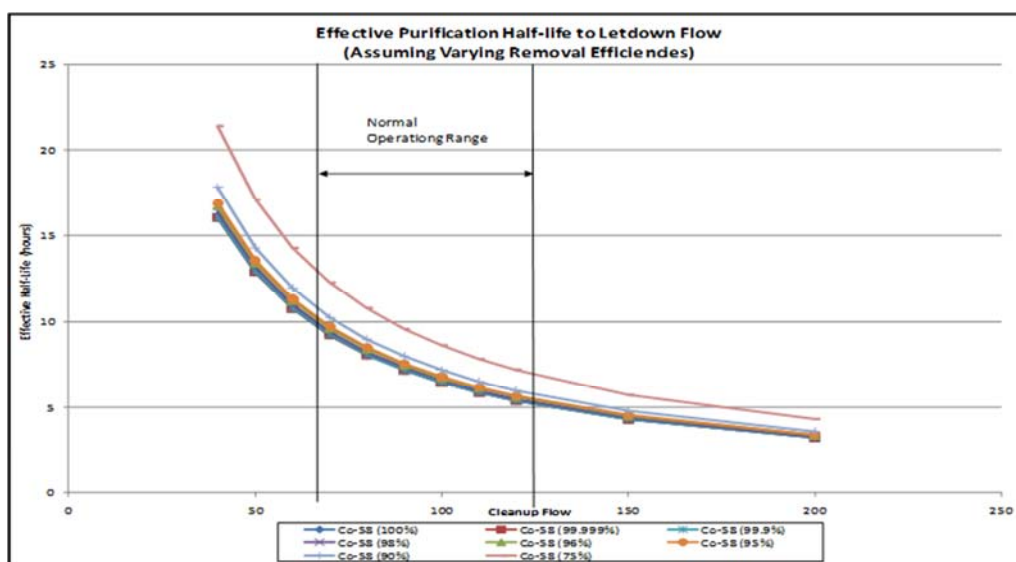

Resin over the years have changed from a standard gel-type resin to macroporous to applications of engineered surface modifications and combinations of several technologies. There are several factors to consider related to optimisation of shutdown clean-up systems including, but not limited to, resin, design modifications to enhance clean-up system capacity, and the chemistry controls applied during shutdown in primary circuits. Each should be evaluated and the limitations of each should be clearly understood and evaluated. As an example; altering the reactor coolant pump operating sequence and durations post-peroxide has been shown to have an impact on magnitude of the ^{58}Co release peak observed in the industry and with maximum pumps in-service it is recognised that an increase risk to insoluble release is present. Other examples include the application of “soft” versus “hard” shutdowns. The application of a soft shutdown through driving rods instead of tripping may or may not have an impact of the insoluble release pattern. Changes to shutdown chemistry should be reviewed by fuel personnel to ensure calculations applied to the fuel design for the next cycle reflect these changes.

Continued improvements and data associated with shutdown chemistry controls, clean-up system optimisation, materials, and core design warrant this area to be followed and reported on in future reports.

3.3.1.2.3 Primary Circuit Filter Application

Primary circuit filtration is typically accomplished through upstream and downstream filters in the clean-up systems located around the demineralisers. The application of the upstream filter is designed to remove particulate material before the demineraliser, while the downstream filters are designed more to minimise the potential impact of resin fines entering the primary circuit and the degradation effects of resin decomposition. These upstream filters can accumulate significant amounts of activated corrosion products compared to the filters downstream of the demineraliser and as a result may be significantly higher in dose rates from each location. The filters are

typically rated from 0.05 to 40 microns with the size selected on operating experience and plant specific experiences. In general terms, the upstream filters are between 1 to 40 microns, while the downstream filters are 1 micron or less, but are very plant specific.

3.3.1.3 Clean-up System Operations (Refuelling and Operations)

This section is only intended to be an overview and a more detailed discussion is beyond the scope of this report.

3.3.1.3.1 Shutdown Operations

The nuclear power industry continues to review and reduce refuelling outage durations. This reduction in time has placed increased demands for plant personnel to clean-up released corrosion products in minimal time, thereby allowing workers to perform refuelling operations in as low as achievable radiation fields. This reduction in time requires personnel to optimise clean-up systems and coordinated efforts by chemistry, radiation protection, and operation personnel.

There are two key factors to consider related to clean-up systems; clean-up flow and resin efficiency improvements.

Figure 9 plots the clean-up times based on clean-up flow improvements only. As expected from Equation 18, clean-up time is significantly improved for the same volume by increasing the clean-up flow. Figure 10 shows the improvement with optimised flow and increasing resin efficiency from 70% to 100%. As expected, this impact is less significant than flow optimisation.

Figure 9: Projected Clean-up Time based on Clean-up flows

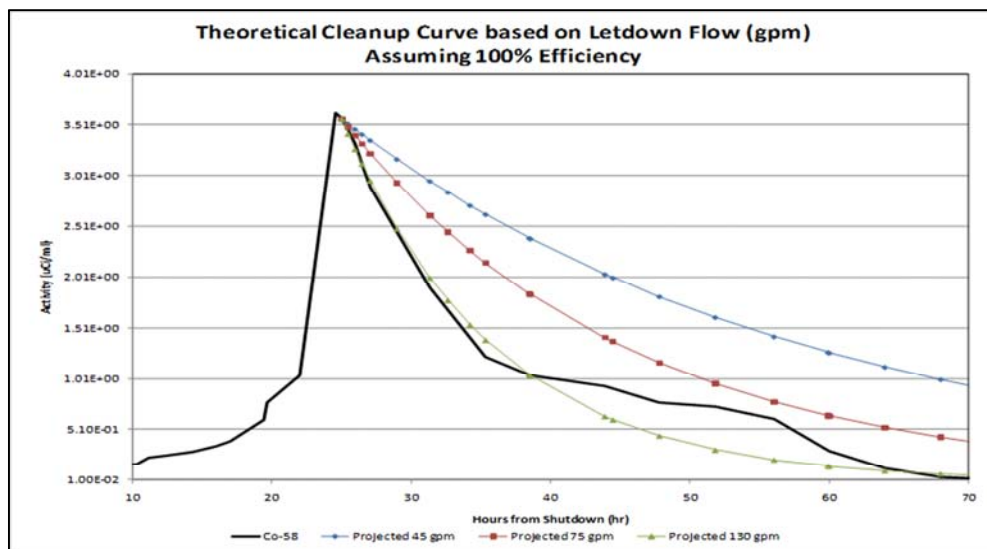
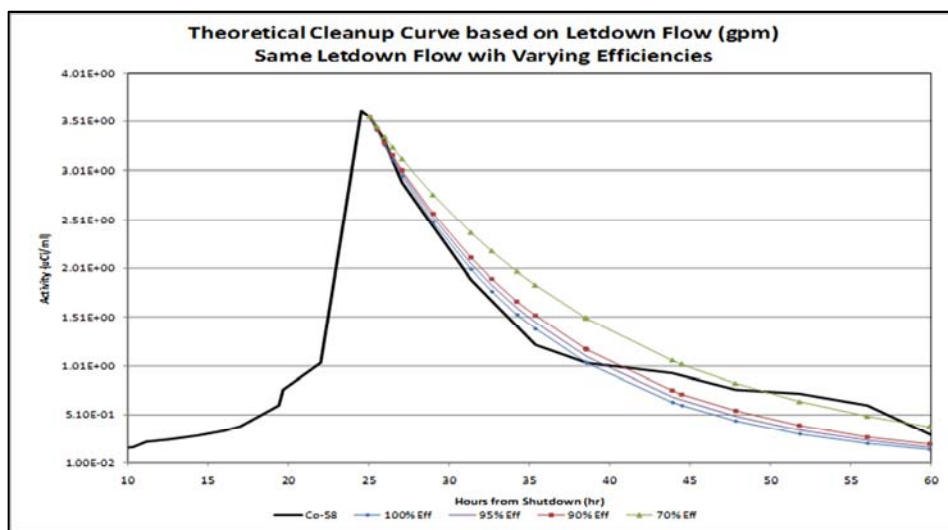

Figure 10: Projected Clean-up Time based on Efficiency Improvements

Based on Equation 18, the key driver to minimise the time for shutdown clean-up activities is to optimise the clean-up flow and/or volume. It should be noted that improvements in clean-up efficiency are always beneficial, especially related to downstream components (i.e., seals, clean-up system piping).

3.3.1.3.2 Normal Operations

As previously stated, the alloys of construction used in the fleet are subject to varying degrees of corrosion and wear, depending on the material composition, chemistry, and thermal - hydraulic conditions. Deposition occurs by precipitation, adsorption, or particle deposition and depends on the nature of the metal oxide developed during operation. Corrosion product deposition on fuel surfaces is much faster than clean-up system removal ($t_{1/2\text{fuel}} \llll t_{1/2\text{purification}}$).

Table 6 lists data on the typical coolant concentrations of species important for activity transport in western-style PWRs according to the EPRI sponsored Chemistry Monitoring and Assessment programme. The typical concentrations are based on equilibrium conditions with nominal clean-up flow. For a normal PWR reactor with clean-up flow maximised, in a given hour only ~ 12% of the coolant is passed through the clean-up system.

A simple calculation shows that under equilibrium conditions and with optimised clean-up flow and a resin efficiency of 100%, there is still a sufficient number of atoms/gram in the primary coolant for oxide uptake. Improved resin can potentially maintain a lower number of atoms/gram in the coolant, but still sufficient atoms are available for uptake.

Table 6: Typical Coolant Concentrations

Species	Typical Concentration, ppb	Typical Concentrations, $\mu\text{Ci/g}$	Atoms/gram
Fe	3		3.24E+13
Nu	0.1		1.026E+12
Cr	<0.01		<1.16E+10
Zn	10		9.13E+13
Co	0.04		4.4E+11
⁵⁸ Co		1.00E-03	3.27E+8
⁶⁰ Co		2.00E-05	1.77E+8
⁵⁴ Mn		8.00E-05	1.15E+8
⁵⁹ Fe		1.00E-05	2.06E+6
⁵¹ Cr		5.00E-04	6.38E+7

3.3.1.4 Clean-up Conclusion

Resins continue to evolve and improve, which in-turn can result in lower coolant concentrations, but are limited due to system design. Improvements in resin efficiencies during shutdown activities from <95% can significantly impact clean-up durations. Reducing the amount of time to reach clean-up goals during shut down operations allows workers to enter into the containment buildings with potentially lower radiation fields and minimising the impact on outage schedules. In this case, optimised resins can impact radiation fields allowing workers to enter the areas sooner.

In looking at a simple refuelling outage resin, clean-up flow and volume reduction, Figure 11 provides the improvement that can be observed.

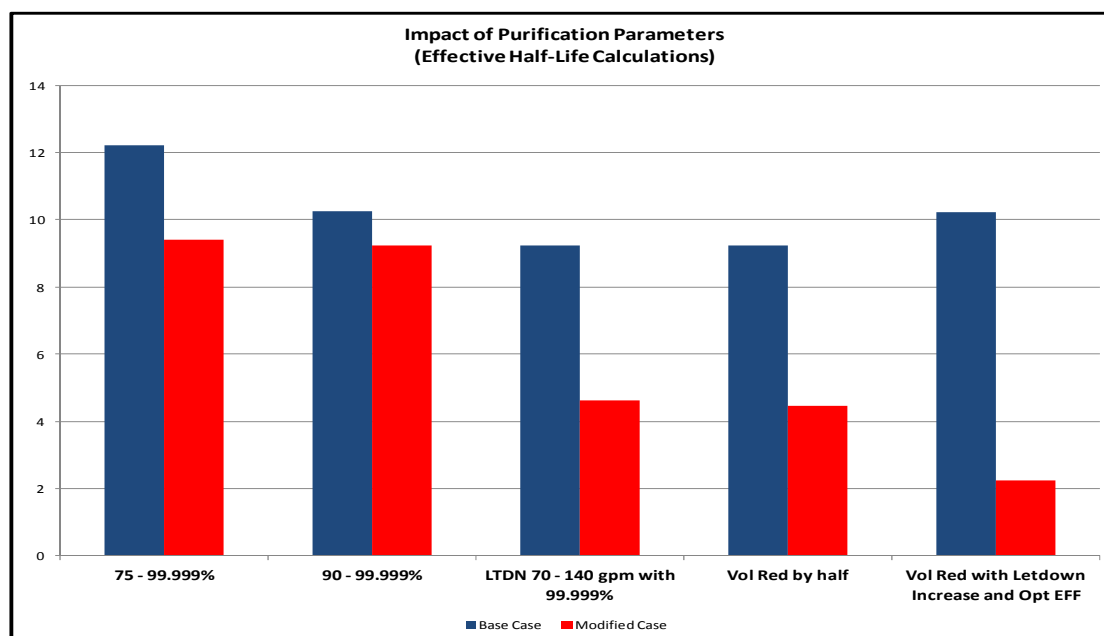
Figure 11: Comparison of Factors Impacting Purification Half-life

Therefore the overall impact is dependent on the condition or operation and should be understood by plant staff.

3.3.2 Pressurised Water Reactors (PWRs)

The plant chemist tool box is limited to primary circuit pH adjustment, hydrogen controls, and zinc injection. Section 3.3.2 covers the western style PWR chemistry options.

3.3.2.1 pH_T Control

The main corrosion issue related to the primary circuit materials is driven by pH, hydrogen and temperature. As shown by Equation 4, even if the concentration of these corrosion products is very low, reactor control and radiation dose rates may be strongly influenced by the deposition of corrosion products on fuel cladding, activation of these corrosion species to radiation source terms, and deposition on out-of-core surfaces.

The Analysis Report on 1999-2001 Field Experience with Elevated Constant pH [12] provides detailed explanations on various pH ranges to optimise nickel release, deposition on fuel, activity transport, deposition, and potential dose reductions.

Chemistry departments have limited options related to primary circuit pH programmes due to fuel concerns and other corrosion related issues. It is expected that in the normal range of operation, primary coolant pH_T (7.0 – 7.4) has minimal impact on corrosion and release rates of associated plant materials. Table 7 is reproduced from Reference [12] to show the potential improvement in corrosion product release for various pH programmes relative to pH_T = 6.9. There is approximately a 4% reduction in corrosion rate by increasing pH_T from 6.9 to 7.1, and by increasing pH an additional 0.1 units would potentially further reduce the release rate by ~1%. Based on current plant performance, there is not an immediate plan to change the primary pH control programme in some utilities and peak cycle lithium is ~3.5 ppm with the 7.2 pH_T regime.

Table 7: Relative Corrosion Rates versus primary pH_T

pH _T	Alloy 600	Stainless Steel
6.5	1.154	1.158
6.9	1.000	1.000
7.1	0.962	0.962
7.2	0.949	0.948
7.4	0.930	0.929

It is well known that a pH lower than 6.9 will induce higher risks of contamination of out-of-core surfaces and of axial offset anomalies. Axial offset anomaly (AOA), or later referred to as Crud Induced Power Shift (CIPS), has been observed in PWR cores with sub-cooled nucleate boiling and sufficient circulating corrosion products. Deposition predominantly takes place on the upper portion of the highest powered fuel assemblies. This effect may cause local core power depression through accumulation (hideout) of borates in corrosion product layer on the fuel rod cladding surface. Many plants have experienced AOA, either mild or severe for one or more fuel cycles. However, other plants that have operated with aggressive thermal conditions have been free of the effect. The most severe occurrences of AOA have been observed at the Callaway PWR.

Through the B/Li coordination, which sets the lithium concentration according to the boric acid concentration, optimum pH_T is defined worldwide between 7.2 and 7.4 depending on the alloys used in the primary system. To ensure the core reactivity control in the PWR, the concentration of boric acid is defined according to the neutron calculations and decreases from the beginning of cycle (BOC) to the end of cycle (EOC). Primary pH_T is mainly defined by the concentration of lithium and boron in the primary water. Nevertheless, there are many factors to optimise primary pH_T control. Some alternatives are listed below:

- fuel management and the cycle length;
- increase of lithium concentration at the BOC;
- use of neutron poisons in some fuel rods to decrease the boron concentration at the BOC;
- use of 10B enriched boric acid to get the same reactivity control with lower boric acid concentrations.

Worldwide, there are many B/Li control programmes in use today. In some cases, limits are based on technical specifications and others may be based on fuel vendor limitations. Examples of primary pH control programmes include “modified”, “elevated Li”, or “constant elevated”.

Figure 12: EDF B/Li Ratio and pH

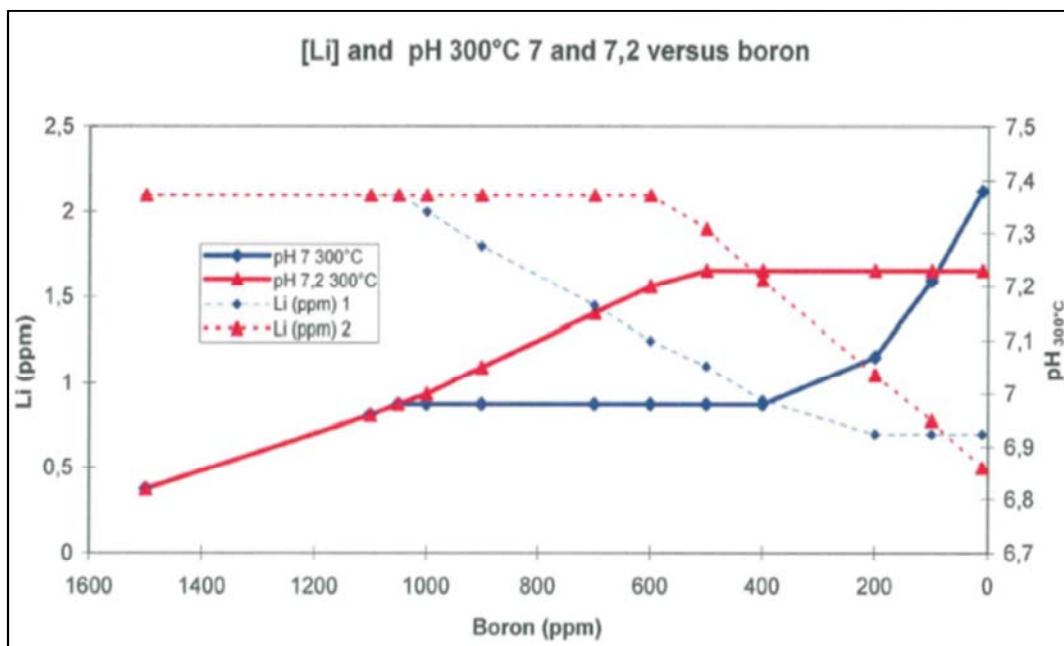

As an example, in 2010 EDF has approximately six plants follow the so-called “modified” B/Li coordination. For all the other EDF reactors, the technical specification is currently at 2.2 ppm maximum lithium concentration (“standard” as defined by EDF) (Figure 12) [13].

Figure 13: Diagram of the three used or foreseen B/Li coordination in EDF PWRs

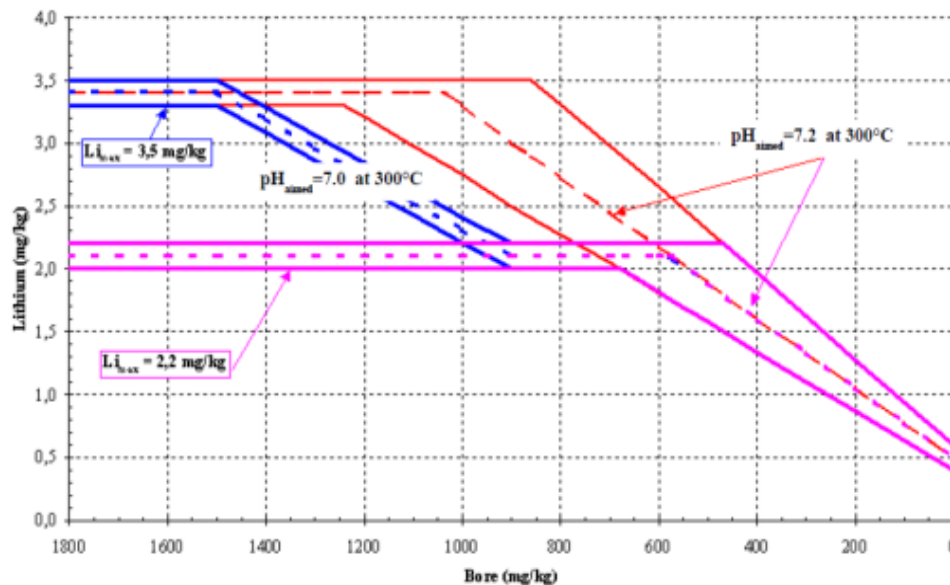

Classic coordination (pink) modified coordination (blue) and elevated lithium coordination (red)

EDF performed many studies in order to test “elevated lithium” control before a possible implementation across the fleet. The main objective of this modification was to raise the maximal lithium concentration from 2.2 ppm to 3.5 ppm to reach as quickly as possible a target pH_T of 7.2 (Figure 13) [13]. Different issues concerning the impacts of increasing the lithium concentration have been taken into account: dose rate and radiation fields, mitigation of axial offset anomalies, and material degradation (cracking mitigation). Concerning the last point, the influence on the main alloys used for the primary system components have been considered.

3.3.2.1.1 Overview of pH_T programme

Plant chemists continue to optimise primary pH programmes considering a wide range of issues. These issues include fuel vendor concerns, fuel management, material corrosion, and any impact on support systems. It is up to plant specific evaluations to determine the optimal pH_T programmes.

3.3.2.2 Zinc injection

Zinc injection is primarily considered as part of an overall dose reduction strategy, although some consider zinc as part of the primary water stress corrosion cracking (PWSCC) mitigation plan. The application of zinc has been successfully performed at approximately 80 PWRs worldwide since the mid-1990s representing 30% of the global PWR fleet.

EDF has developed a strategy for taking advantage of zinc injection. The target zinc concentration has been fixed considering the benefits expected for material corrosion, source term reduction and radiation fields. Safety analysis, Chemical Specifications, Operational Guides have been elaborated to facilitate the NPP actions permitting the zinc injection continuation at Bugey 2 and Bugey 4. Regarding radiation field reduction, zinc injection has not clearly shown positive results but no contra-indication has been

highlighted neither. Nevertheless, the main interest in zinc injection is its multiple benefits and the implementation at 14 more EDF units from 2010 to 2012 has been decided not only for dose rates reduction but also for PWSCC and AOA mitigation. Zinc injection should be considered as a strategy with benefits in the short, medium and long term.

3.3.2.2 Conclusion

NPP operational experience and laboratory results show that zinc injection application seems to provide positive effects in all of these domains without inducing adverse impacts. EDF has developed a strategy to implement zinc injection in its fleet.

Nevertheless, even if the popularity of zinc injection is due to its fast impact on surface contamination, the main interest of zinc injection is its multiple benefits not only for dose rates reduction but also for PWSCC and AOA mitigation. The zinc injection should be considered as a strategy with benefits in short, medium and long term.

3.3.2.3 Shut down and start-up operations

During the shutdown, physico-chemical conditions can significantly vary: pressure and temperature drop, hydrogen content decreases, boron and lithium concentrations changes, hydrogen peroxide is injected, the primary fluid switches from reducing to oxidising conditions. These changes of the primary water conditions result in the dissolution of deposits on fuel assemblies. Because of the oxygenation, corrosion product activity concentrations significantly increase in the primary circuit, especially the ^{58}Co volume activity. The level and form of ^{58}Co activity at forced oxygenation drives the clean-up time required to reach the activity threshold for which the RCS breaking can occur, thus impacting the outage duration. In order to minimise and decrease this activity, various parameters can be taken into account, such as the surface state of the tubes.

The objectives in terms of chemistry/radiochemistry will depend on shutdown and restart scenarios considered and must ensure a balance between various constraints:

- Adjust the concentration of hydrogen and lithium in the primary coolant, based on the type of outage targeted.
- Reduce as soon as possible the activity concentration of the primary coolant by purification.
- Minimise the risk of surfaces recontamination out of the primary circuit neutron flux.
- Minimise the risk of material degradation of the primary circuit (corrosion).
- Facilitate planned interventions during outage, near the primary circuit and its adjacent auxiliaries (fuel handling, maintenance).
- Minimise the risk of personnel contamination by fission gas release in case of breach of the integrity of the primary circuit.
- Control environmental impacts.
- Manage the outage planning.

Depending on initial and final state, it would be possible to change from basic and reducing conditions to acid and oxidising conditions. These modifications can lead to a number of risks that need to be taken care of, in particular:

- H_2/O_2 mixtures: ignition, detonation.

- Integrity of materials: corrosion.
- Radiation protection.
- Environment: radioactive and chemical effluents generation.
- Availability: outage duration extension.

To achieve the goals stated above, some parameters can be adjusted to optimise the chemical treatment of the primary coolant. It is essentially the pH (Li concentration) and redox potential (H_2 or O_2 concentration). Shutdown and restart transients lead to important changes of the physical and chemical parameters of the reactor primary coolant.

^{110m}Ag

^{110m}Ag can contribute to $\geq 90\%$ of the total dose rates in these auxiliary systems, though it only contributes 5 – 15% of the total dosimetry. The indication of ^{110m}Ag contamination can impact the outage schedule, and may require additional control rod inspections and/or replacements.

Unlike other corrosion products for which dissolution is at the maximum concentrations during the oxygenation peak, silver dissolution shows a trend to go on after the effective oxygenation (dissolved oxygen concentration close to 1 mg/kg). The volumetric activity of ^{110m}Ag in the primary coolant stays at a low level (1-10 MBq/m³) due to the low silver solubility in a reducing medium. Activity increases to > 10 MBq/t indicate ^{110m}Ag contamination post-oxidation. During shutdown, in case of silver pollution, the observed levels of activity increase by several decades during and following oxygenation. These changes are most likely due to changes in solubility and transitioning from reducing to oxidising conditions.

Generally, the silver peak activity appears 1 to 12 hours after the ^{58}Co peak. Table 8 provides additional information related to silver peaks for EDF fleet in the year 2007.

Table 8: ^{110m}Ag peak activity, 900 and 1.300 MWe French Standardised plant series in 2007

Standardised plant series	^{110m}Ag average	^{110m}Ag maximum	^{110m}Ag minimum
900 MWe	0.91 GBq/ m ³	3.71 GBq/ m ³	0.16 GBq/ m ³
1300 MWe	0.17 GBq/ m ³	0.24 GBq/ m ³	0.12 GBq/ m ³

There is no clear correlation between the ^{110m}Ag activity peak and the other corrosion products. A first level of assessment can lead to consider that RCS is polluted when ^{110m}Ag peak during shutdown is higher than 0,5 GBq/m³ on primary coolant sample.

The observation of different and unpredictable behaviour of silver, mostly measured by gamma-spectroscopy and particularly during different cold shutdowns, even in a same plant, seems surprising when the operation schedule seems stable. Measurements demonstrated that it is possible to decrease the steam generator channel head silver contamination and to increase CVCS exchanger contamination.

Depending on the chemical environment and physical properties (pH, redox potential, etc.) silver would be:

- In ionic form in solution, Ag (I) cation.
- In colloidal form.

Studies conducted by EDF outlined the essential simultaneous impact of redox potential, pH, and temperature on silver behaviour [14]. Over a large range of pH (corresponding to the nominal operating conditions or to the shutdown ones at 300°C, 80°C and 30°C), and in different locations of the RCS, CVCS and RHR, Ag(0) and Ag⁺ can be simultaneously found on thermodynamic stability diagram and are very sensitive to the redox variation and the concentration.

On the opposite, pH is determinant on colloids behaviour. Electrostatic repulsion between them is the lowest at the iso-electric point, i.e., at the pH for which the zeta potential is zero. However, the kinetic behaviour of silver under primary coolant conditions is not well understood.

Thus, optimisation of its removal is difficult, with preferential deposition of ^{110m}Ag taking place in “cold points” of the auxiliary systems exchangers, where the thermal gradient is important. This also may elucidate the apparent degrading conditions of the purification. The goal will become to manage the silver so as to transport it in a form removable by the purification system.

Shutdown purification

During oxygenation, antimony is not retained on a 0.45 µm filter and therefore is considered to be dissolved. When antimony pollution occurs, the reactor coolant lithium content has to be lower than 1 ppm in order to improve purification by the ion exchange resins. In order to obtain acidic conditions, purification is completed using the non-saturated lithium cation bed demineralisers of the Boron Recycle System. Nevertheless, it should be noted that an acid-oxidising reactor coolant seems to increase antimony deposition on the primary circuit surfaces. This is likely related to presence of antimines and their interaction with positively charged oxide surfaces.

As for silver behaviour, to deal with antimony pollution, operators face some difficulties related to the different physical and chemical conditions of the RCS and the auxiliary systems. Except for removing the root cause, the objective consists in the optimisation of the chemical form of the antimony to enable the purification line to remove it.

^{110m}Ag purification is performed on a dedicated ion exchanger operating at the maximum possible flow rate. During shutdown, when the filters are replaced, purification must not be suspended. Filters consistent with colloid removal are required. Thus, silver removal is improved and downstream resin pollution may be avoided (poisoning by colloids). If the upstream filter is not redundant, the filter replacement must lead to reduce by half the CVCS flow rate purification to minimise resins pollutions. The background and the resin features show that macro porous mixed-bed would be the most adapted for soluble silver and silver colloids. The pressure drop must be specially monitored.

Until now, the feedback demonstrated that withdrawing lithium from the primary coolant with a non-lithiated mixed bed ion exchanger during shutdown, resulting in a lower pH, improves the silver removal efficiency. Without fuel cladding failure, lithium can be eliminated starting from the rods drop.

Antimony

In some French PWRs, ¹²²Sb and ¹²⁴Sb volumetric activity peaks have been observed, at various times with peaks higher than ⁵⁸Co peaks (Table 9). These two radionuclides compound dosimetry measurements and produce difficulties with waste processing management. ¹²²Sb and ¹²⁴Sb are two multi gamma emitters with radioactive half-lives of 2.7 days and 60.2 days, respectively. Though released in higher concentrations, ¹²²Sb with a short radioactive half-life has minimal impact on radiation fields to workers, but

provides staff with the ability to use in source determination according to the internal EDF documentation.

Table 9: Mean and maximum volumetric activities encountered at the oxygenation peak on the EDF fleet (1995-2007)

Standardised plant series	Values	¹²² Sb (MBq/m ³)	¹²⁴ Sb (MBq/m ³)	⁵⁸ Co (GBq/m ³)
900 MWe first series	Mean	6	5	224
	Maximum	8	8	460
900 MWe	Mean	7	6	113
	Maximum	24	19	550
1300 MWe	Mean	14	13	146
	Maximum	136	137	240

Two major sources have been identified in the PWR fleet:

- Pumps bearing wear in the Boron Recycle System, where the bearings are graphite impregnated with ~10% antimony.
- Secondary Start-up Sources: In some cases, PWRs utilise a secondary start-up source to produce neutrons for reactor start-up. These sources are composed of an antimony-beryllium source encased in stainless steel and used over several cycles and then replaced, as required, for subsequent cycles. These start-up sources are composed of ~50-50% beryllium-antimony, respectively.

A few grams of activated antimony can explain such peaks of ¹²²Sb and ¹²⁴Sb. Calculations demonstrate that about 7 grams can lead to a ¹²⁴Sb peak of 100 GBq/m³. The important antimony released activity has an impact both on dosimetry and waste management. ¹²⁴Sb deposited activities on out-of-core surfaces increase significantly as shown in Table 10.

Table 10: RCS recontamination after a ¹²⁴Sb peak of 70 GBq/m³

¹²⁴ Sb (GBq/m ²)	Before H ₂ O ₂	After H ₂ O ₂ injection
Hot leg	0.29	1.02
SG tubing	0.32	0.95

As a result, ¹²⁴Sb contribution to the total dose rates can reach 10% in some parts of circuits. And the dosimetry for maintenance during a plant shutdown can increase to about 5% because of ¹²⁴Sb contamination.

EDF studies, elaborating pH-Potential diagrams at normal operating conditions (300°C) and at forced oxygenation conditions at 80°C confirmed the behaviour observed on plants. It seems that, under nominal conditions at 300°C, metallic antimony is likely more stable in aqueous reducing medium. For shutdown conditions at forced oxygenation, it seems that the more stable species is at the limit of the SbO₃⁻ area in aqueous solution. Eliminating antimony as well as possible becomes easier in this zone.

Preventive strategy

To avoid antimony pollution, the incriminated pump bearings have been replaced by antimony free pump bearings. As indicated in the table below (Table 11), this allows making the ¹²⁴Sb peaks decrease.

Table 11: Bearing replacement consequence during the 14th cycle

Cycles	13	14*	15
¹²⁴ Sb (GBq/m ³)	100	60	20

3.3.3 Water-Water Energetic Reactors (VVERs)

The Russian designed VVER is similar yet, very different compared to other PWR designs. The distinguishing or key design differences compared to other OWR designs include the usage of horizontal steam generator tubes (stainless steel), application of hexahedral fuel assemblies, and a high capacity pressuriser for safety.

The horizontal steam generator tubing applies stainless steel compared to the application of Inconel™ 600, 690, and 800 in the steam generators, thereby minimising the corrosion product source term for activation. Figure 14 captures an overview of the VVER-1000 primary circuit layout. The VVER materials result in excellent corrosion product behaviour, which in turn produces lower circulating nickel and cobalt concentrations and low ⁵⁸Co and ⁶⁰Co surface activities. These lower activities provide the basis for the lower dose rates or source term.

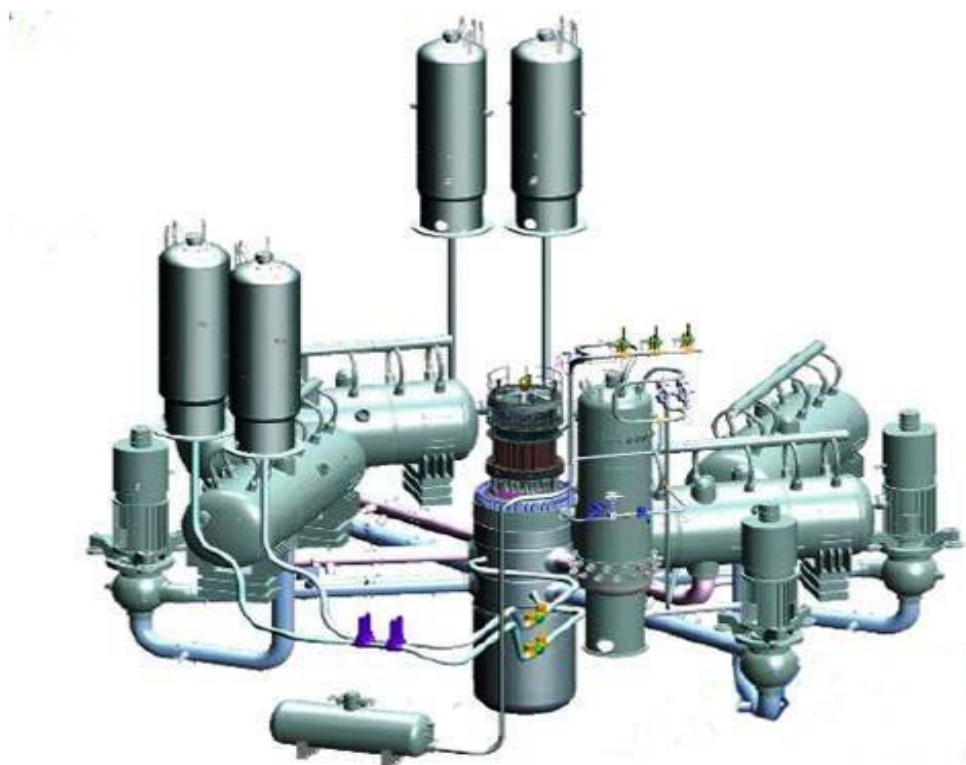
Figure 14: VVER-1000 Primary Circuit Layout

Primary chemistry controls are slightly different compared to the other PWR fleet units. PWRs, previously described utilise lithium-7 hydroxide to maintain a slightly alkaline environment with hydrogen applied through makeup tanks or the volume control tank. The VVER fleet applies potassium hydroxide to support the primary circuit pH goals with ammonia and hydrazine decomposition to support hydrogen production. Section 3.3.3 provides an overview of the VVER considerations.

3.3.3.1 pH Control

Primary chemistry specifications represents a standard part of fresh fuel delivery documentation and was elaborated by Kurchatov's Institute in Moscow. The specifications for most of the parameters are very similar to those for PWRs. Some key primary chemistry differences are listed below:

- Potassium is used for pH control instead of lithium – this results in a less restrictive start-up chemistry and allows to a more favourable $\text{pH}_{(T)}$ to be reached. Therefore, CIPS risks are much lower, and when occurred they were rather consequences of primary equipment decontamination as discussed later
- Ammonium hydroxide is used to generate hydrogen in the primary coolant instead of injecting gaseous hydrogen. This gives rise to some difficulties in maintaining a stable $\text{pH}_{(T)}$ as ammonia competes with potassium on the primary clean-up cation resin. The role of ammonia in the reduction of dose rates is still not well understood.
- Full primary pressure ion-exchange clean-up system (VVER-440) is used with additional primary clean-up system capacity on the feed and bleed system
- High temperature, high flow filters loaded with porous (sponge) titanium (VVER-1000) – these filters definitely remove significant activity from the primary coolant but the need for their regeneration in the case of exhaustion/saturation was not foreseen by the design. Some wash-out processes have already been tested in Russian reactors.

Within the primary chemistry standard, the specification of the potassium – boron relationship was originally specified as shown in the Figure 15 and 16 – blue boundaries. The latest version of the boron – potassium chemistry specification – see violet boundaries in both figures, is very similar to current PWR specifications and allows higher $\text{pH}(300^\circ\text{C})$ values at the cycle beginning, but also reflects the different primary system construction materials [15].

Figure 15: Boron/potassium co-ordination for the standard and modified/updated water chemistry of VVER-440 units

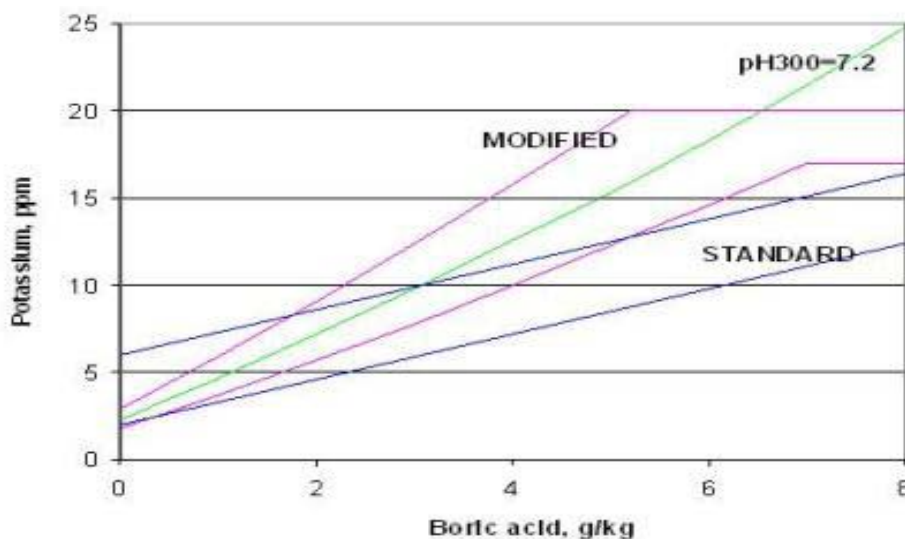
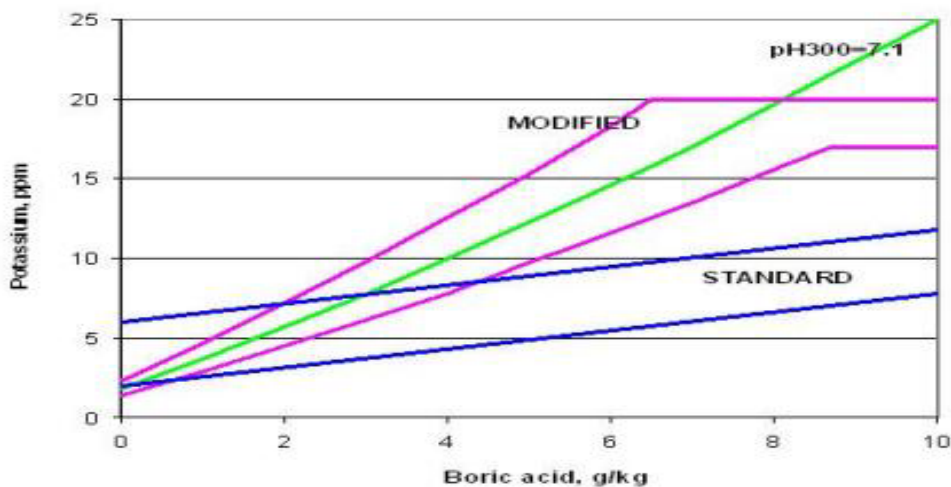

Figure 16: Boron/potassium co-ordination for the standard and modified/updated water chemistry of VVER-1000 units



From the very beginning of this type reactors operation, the standard specifications lead to low $\text{pH}(300^\circ\text{C})$ values at the beginning of cycle and allowed relatively high $\text{pH}(300^\circ\text{C})$ values at the end of cycle. There were also several temporary standards developed in the 1990s and some non-Russian plants have introduced their own specifications approved by the corresponding national nuclear regulatory authority. Modified or updated chemistry in this regard brought boron-alkali coordination to a comparable status as for PWRs.

An example of the actual $\text{pH}(300^\circ\text{C})$ during a cycle with standard and modified boron-potassium coordination is shown in Figure 17.

Figure 17: Example of typical $\text{pH}(300^\circ\text{C})$ for the standard and modified water chemistries during the reactor cycle (VVER-440 unit) [15]

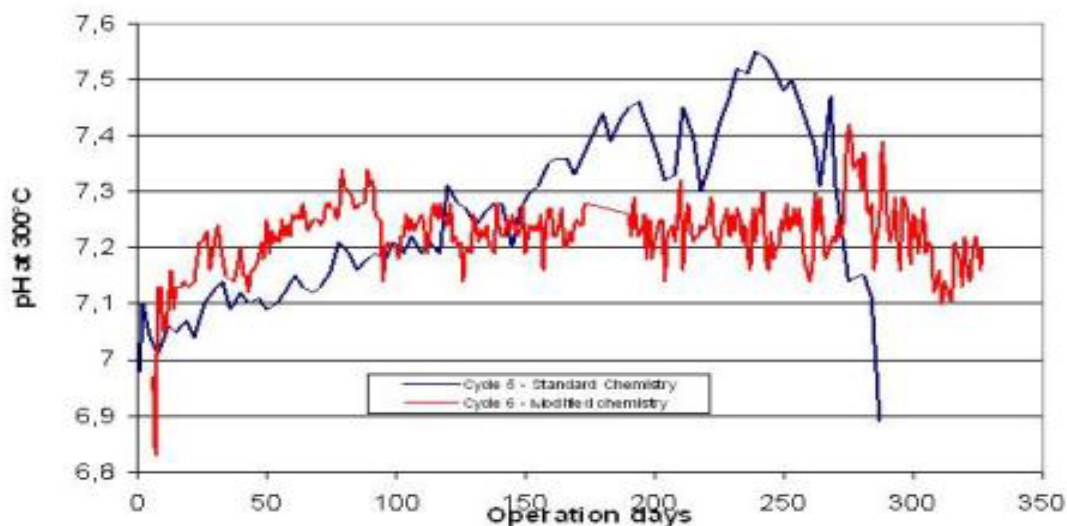

Despite several analytical studies and also experimental work performed in the recent past, the role of some primary chemistry factors in the build-up of radiation fields has not yet been clarified. Usually several factors contribute concurrently to corrosion and corrosion product transport processes, such as boron –potassium control mode,

ammonia concentration, hydrogen concentration, makeup and clean-up system operation modes, various shutdown practices, HFT passivation process and, in recent years, power uprating. There is no systematic database of the VVER fleet that allows a comprehensive evaluation of chemistry and operating practices, and therefore no clear identification of positive factors can be easily made. The role of the following chemistry factors has been investigated:

Ammonia/hydrogen

The ammonia concentration has to be maintained to assure a specified concentration of hydrogen. Depending on the primary makeup operation mode (rate of makeup flow/primary coolant degassification), the desired concentration of hydrogen can be achieved with an ammonia concentration in the range 5–50 ppm as shown in the Figure 18.

Figure 18: Hydrogen/ammonia ratio at Russian NPPs with reactors VVER-440 and 1000 [15]

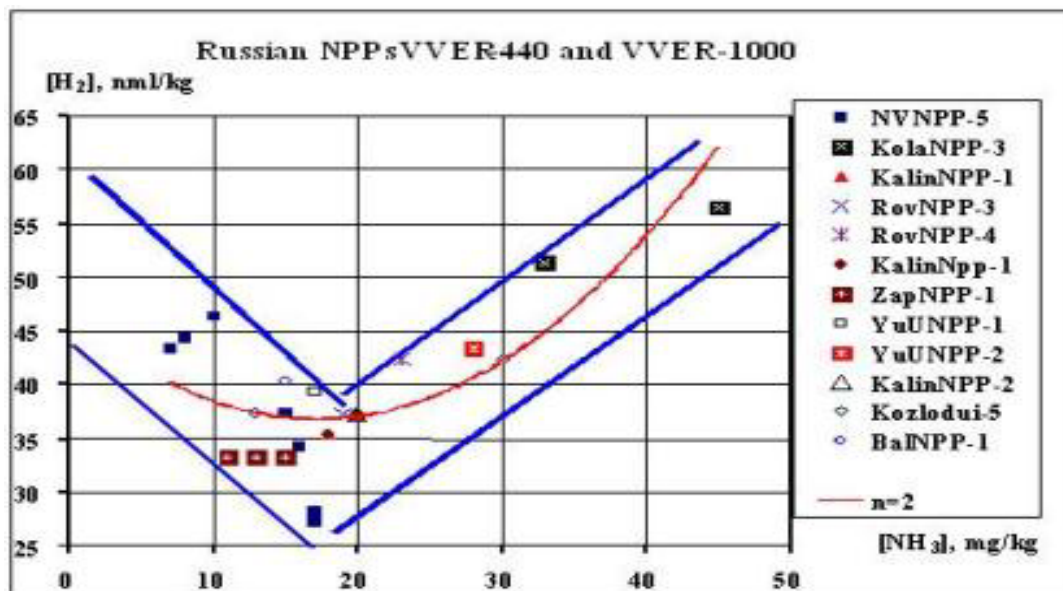

As use of ammonia brings some problems in liquid radioactive waste processing at VVER units, there is an on-going effort to minimise its concentration either by minimisation of primary coolant degassing or by replacement of ammonia by gaseous hydrogen injection as is done at PWRs.

VVER operators are using various ammonia/hydrogen approaches: low constant ammonia, high constant ammonia or variable ammonia with high concentration at the cycle beginning to moderate/low ammonia at the end of cycle (this mode is used to control the potassium concentration). The hydrogen concentration can vary without clear link to ammonia based on primary coolant degassification rates.

As an example, the history of NPP Bohunice unit EBO-3 primary chemistry and primary loop surface activities is shown in Figure 19. Here it can be seen that the transition from low ammonia/hydrogen in years 2000–2006 to variable ammonia since 2007 did not influence primary loop surface activities (or this effect cannot be clearly identified because of the complex factors and environment).

Figure 19: Primary chemistry and primary loop surface activities history of VVER-440 unit EBO-3

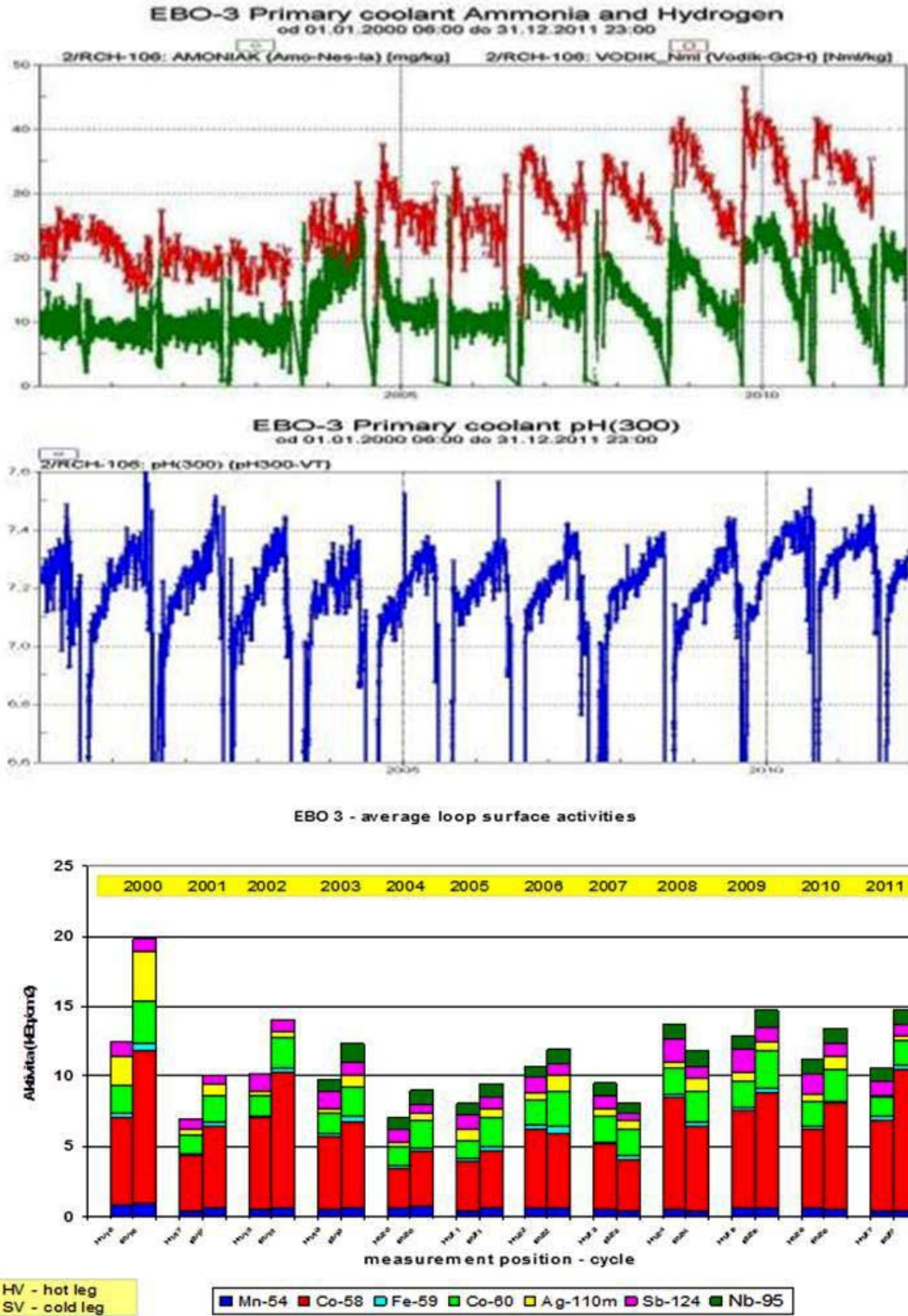

In order to test the influence of ammonia in the primary coolant, low and high ammonia comparative tests have been performed at the experimental loop facility in NRI Rez in Czech Republic in the years 2003–2006 [16].

Based on results of these tests showing positive effect of high ammonia, a plant trial was performed at the unit Dukovany–4 (VVER–440) during three cycles and later on at Dukovany–3 during two cycles [17]. As shown in Figure 20 and Figure 21, primary loop surface activities increased during after two cycles at both units and then slightly decreased after the third cycle at Dukovany–4, but significantly decreased after the following cycle with return to normal ammonia values, so the influence of ammonia concentration when evaluated individually seems inconsistent.

Figure 20: NPP Dukovany–4 primary chemistry

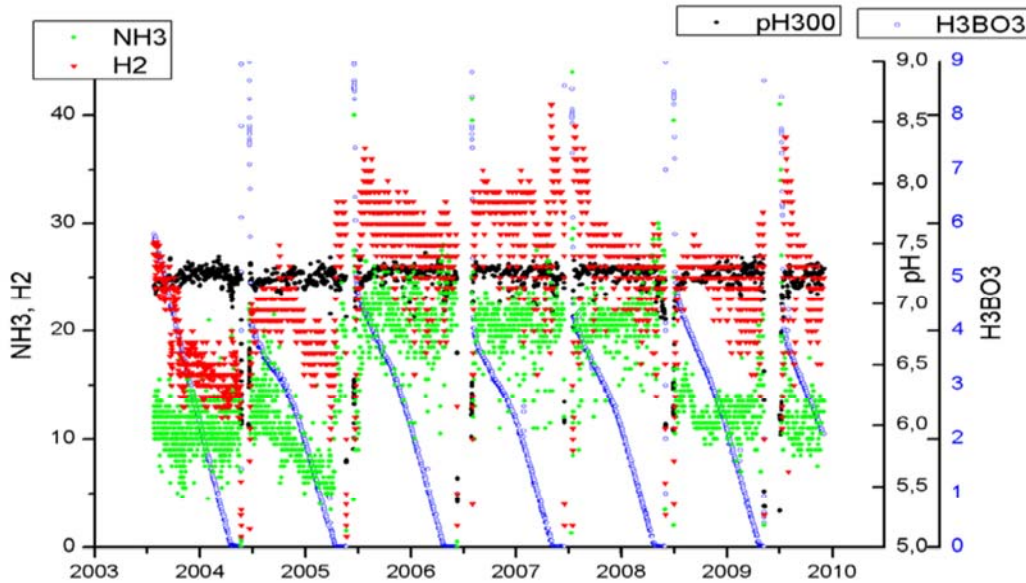
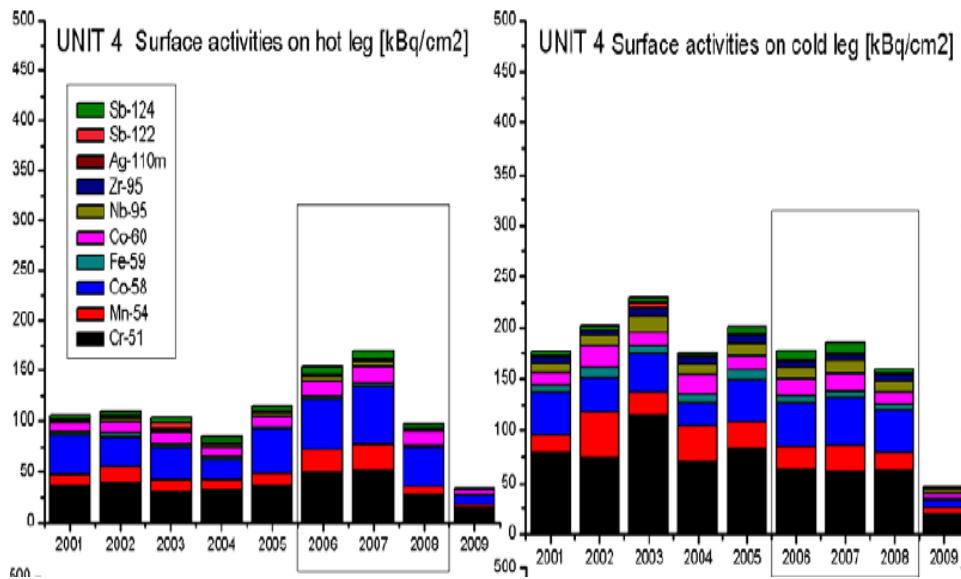

Figure 21: NPP Dukovany–4 primary loop activities



A specific type of high hydrogen, high ammonia chemistry involves injection of hydrazine, which had been first tested at the Russian Kola NPP [18, 19] and later tested or implemented at to the plants including NPP Paks in the 1990s. This chemistry was based on continuous injection of hydrazine into the primary coolant and it was aimed at removal of rough outer oxide layers and the creation of a compact smooth protective oxide layer with reduced corrosion product deposition. One of the observed side effects was a significant increase in radiation fields during the first outage as the primary clean-up system was unable to remove all the mobilised corrosion products. As a result they were redistributed throughout the entire primary circuit, also causing problems with reactor protection cluster absorbers mobility. As hydrazine chemistry is also accompanied by high ammonia and hydrogen concentrations, the effect of hydrazine cannot be easily and clearly distinguished from those of ammonia and hydrogen. Moreover, at some plants like NPP Paks, its effect has been combined with other operational influences (variation of $\text{pH}_{(300^\circ\text{C})}$) which made evaluation even more difficult. As hydrazine chemistry results were not convincing there is a declining tendency for use at plants where it is still being used.

Potassium – Boron ratio or $\text{pH}_{(300^\circ\text{C})}$

As mentioned above two basic specifications exist, so comparison of results with the old and updated relation can be made to assess the influence of this parameter on dose rate build-up processes. Such an analysis was made for the Slovak NPP Bohunice units EBO-3 and EBO-4. In this analysis, the influence of $\text{pH}_{(300^\circ\text{C})}$ on start-up, mid cycle and pre-shutdown periods was studied [19]. In this work, the results did not identify consistent positive feedback of keeping minimal deviation of $\text{pH}_{(300^\circ\text{C})}$ from value 7.2, but as mentioned above, due to several overlapping factors identification of simple parameter role is very difficult as can be seen in Figure 22 and Figure 23. On the other hand, a recent comparison of $\text{pH}_{(300^\circ\text{C})}$ data for “best” and “worst” cycle (by surface activities) within the period 2006-2012 shows that there is a potentially negative impact of high $\text{pH}_{(300^\circ\text{C})}$ in the last period of the cycle to the dose rate build up due to increased ^{58}Co surface activity, as demonstrated in Figure 23 and Figure 24.

Figure 22: NPP Bohunice Unit EBO-3 Primary coolant pH (300)

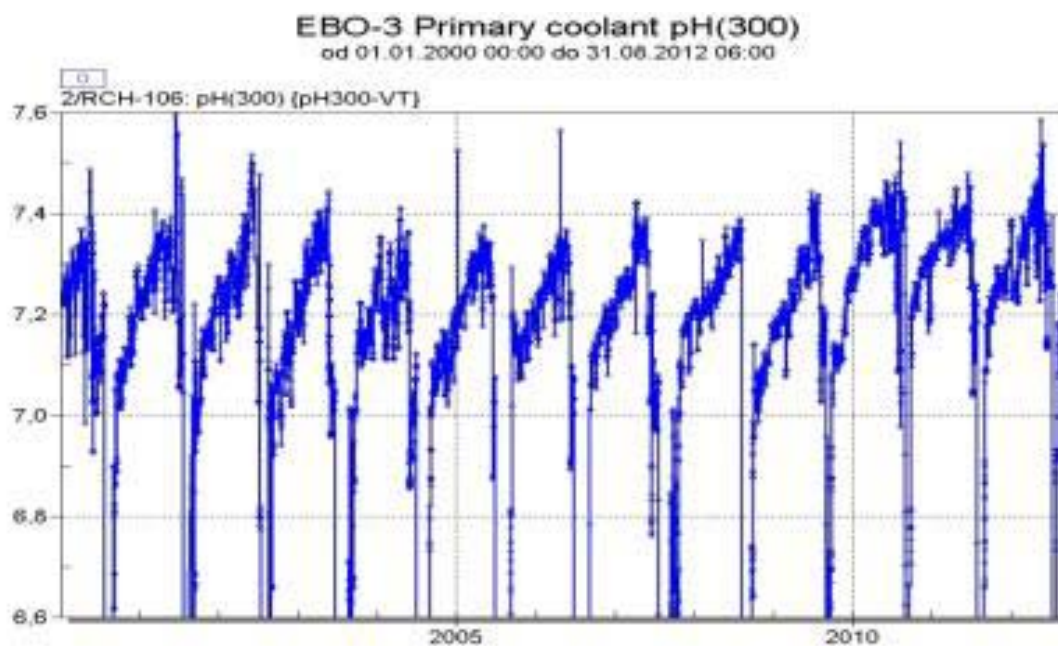

Figure 23: NPP Bohunice Unit EBO-3 Primary surface activities

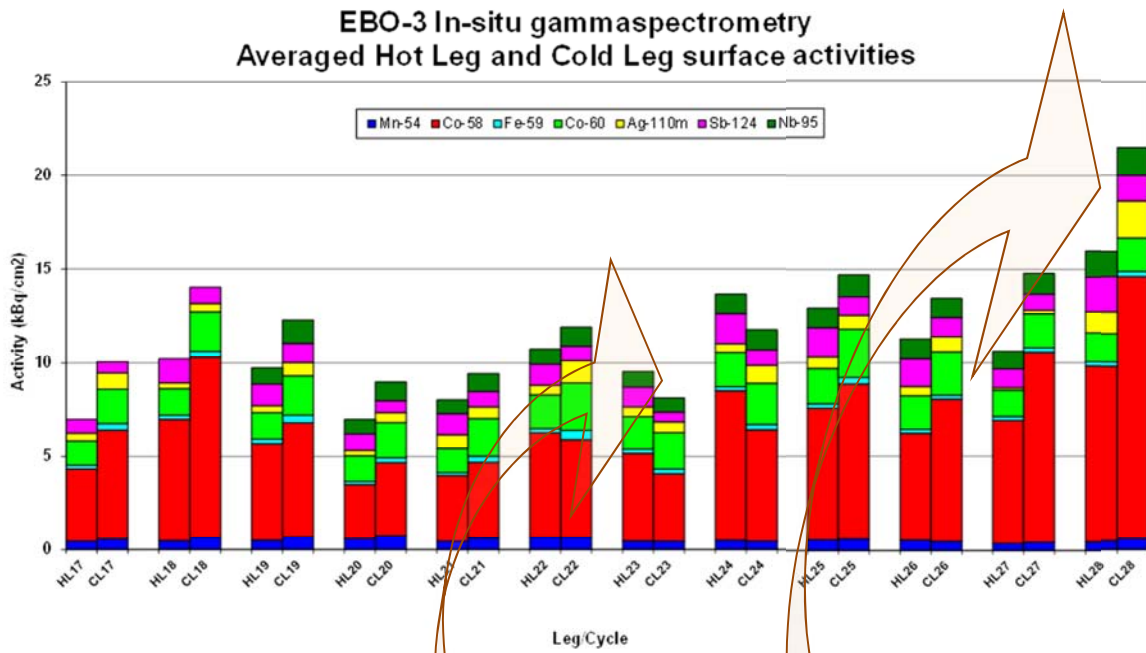
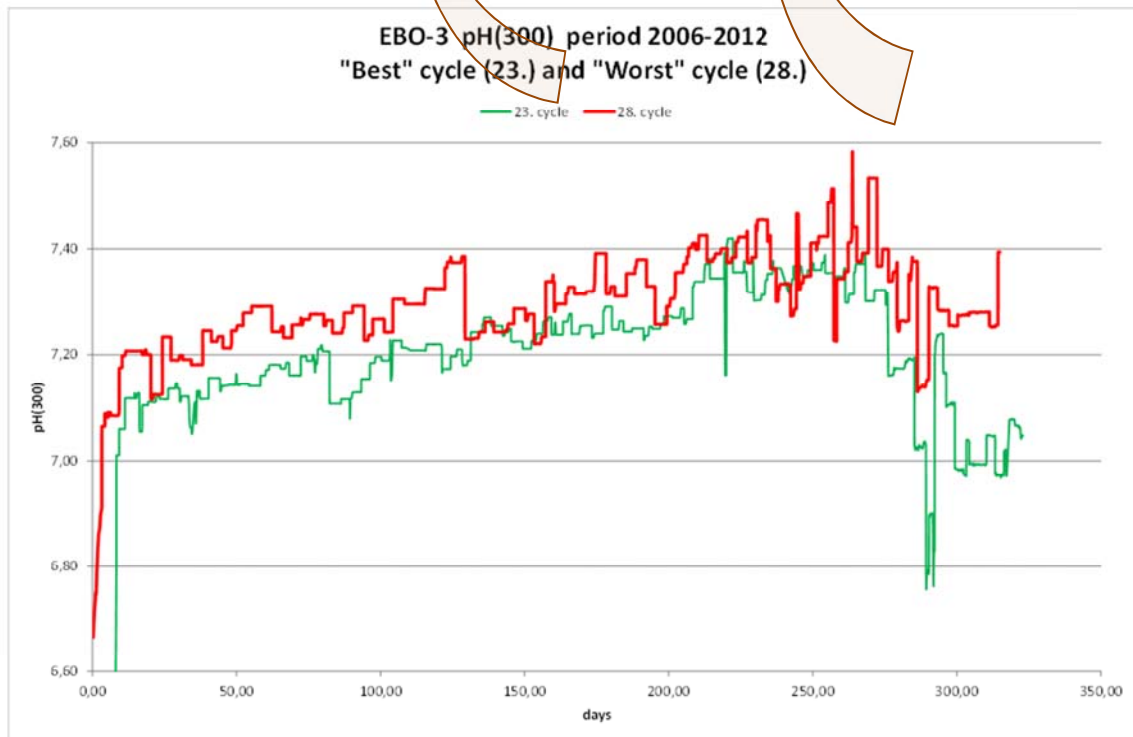

Figure 24: NPP Bohunice Unit EBO-3 Comparison of primary coolant pH (300) for Best and Worst Cycles



3.3.3.2 Zinc injection

Mainly due to differences in material concept discussed in Chapter 3.3.2.1 which leads to much lower cobalt isotope activities, the need for zinc injection technology is less pronounced at VVERs. That is reason why there is no real experience with zinc injection at VVER units at present. Some theoretical studies are on-going and loop tests performed by NRI Rez have demonstrated the potential for dose rate improvement for VVER units [16]. Zinc injection is not recommended for operating VVER-1000 units due to the risk of cobalt washout from the titanium sponge high temperature filters.

3.3.3.3 Shut down and start-up operations

Similarly to PWRs, the major pollutants responsible for over-contamination are:

- ^{110m}Ag , the origin of which is still not satisfactorily resolved – it may come from materials like welds, solders, various seals; or even as an impurity in chemicals such as ammonia, potassium hydroxide.
- $^{122}\text{Sb}/^{124}\text{Sb}$ coming from seals of various pumps – at Loviisa NPP, one of the most important sources is the graphite seals of the Main Coolant Pumps, where the content of antimony is > 25%.

Depending on the plant their overall input to dose rates varies from fraction of a per cent to tens of per cent as shown later, and correspondingly, various targeted mitigation strategies are implemented.

When the shutdown process is considered it can be mentioned again that, mainly due to the much lower cobalt radioisotope activity, there is no need for forced oxygenation during shutdown and shutdown practices are much less developed and unified at VVER units when compared to PWRs.

Many plants developed their own procedures including early hydrogen removal and conversion to acidic primary coolant conditions by removal of potassium from the coolant, but some plants are also using coordinated pH chemistry, injecting potassium during primary coolant –boration in order to minimise mobilisation of highly active in-core deposits. None of implemented procedures has been found to result in an undisputable positive effect in radiation fields reduction so far and there are still studies underway focused on this subject.

Start-up chemistry play also important role in deposit formation as discussed previously. There is general consensus on the need to reach $\text{pH}_{(\text{T})}$ close to 7,0 as soon as possible after start-up. At VVER plants this is often influenced by primary clean-up resin replacement. Cation resins are converted into an ammonia-potassium form during start-up. This conversion is made by multiple injections of potassium-ammonia into the primary circuit that may delay reaching the desired pH for up to 2 weeks. A study performed at NPP Bohunice did not identify a clear influence of the start-up chemistry on the primary loop surface activities [20].

HFT passivation

Hot functional test (HFT) passivation was understood to have significant role in future dose rate build-up, so this process was more closely monitored and controlled in recently commissioned reactor units. There is a very clear demonstration of the influence of the quality of HFT passivation on primary loop surface activities from Slovak NPP Mochovce experience as shown in Figure 25, where a systematic difference between the two units remains remarkable over long operational period [21].

Figure 25: Surface activities measured after first and second cycle of Mochovce-1 (partial HFT passivation) and Mochovce-2 (good HFT passivation)

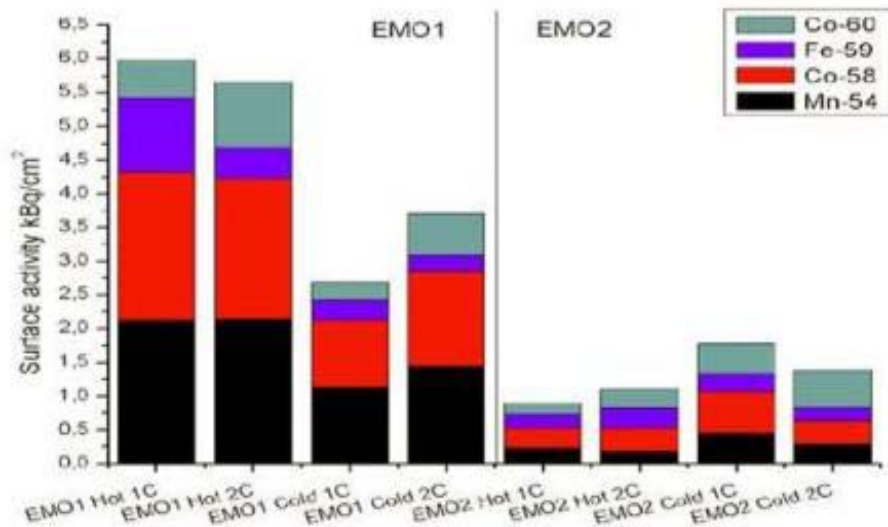

3.3.3.4 Purification

Last vintages of VVER-440 reactors are by design equipped with full pressure primary coolant purification in two parallel clean-up systems, one with mixed bed filter and second with separate cation and anion filters with a design flow of 20m³/h. These two systems are used in different ways by various VVER operators, some of them switching between them in subsequent cycles, some of them operating both all the time. The cation resins in these systems are working in an ammonia/potassium cycle and therefore they are buffering any changes of potassium and ammonia concentration in the primary coolant.

In addition, the primary feed and bleed purification system is available with separate cation and anion filters and a design flow of 40m³/h. This system is mostly used for potassium and boric acid removal and during the reactor shutdown process for corrosion/fission product removal. So far there has not been any reported consistent correlation of this clean-up system operation and radiation fields.

Advanced designs of VVER-1000 reactors are equipped with full pressure, full temperature filters filled with porous Ti particles – depending on design there are two to four such a filters powered by pressure drop of the MCP and working with a flow 100 m³/h. These filters are removing corrosion products from primary coolant.

Similarly to VVER-440, the primary feed and bleed purification system is available with separate cation and anion filters and a design flow of 40m³/h. This system works permanently and specific filters are used for potassium and boric acid removal and during reactor shutdown process for corrosion/fission product removal.

3.3.4 Pressurised Heavy Water Reactors (PHWRs)

3.3.4.1 Chemistry

PHWRs have a separate moderator system for reactivity control so that the primary coolant does not contain boric acid, leading to a much simpler primary coolant chemistry regime compared to PWRs and VVERs. The dissolved lithium concentration (pH_a) of the

HTS is kept constant during normal operation and shutdown; pH_a is the pH measured in heavy water by a glass-membrane pH electrode that has been calibrated using light-water buffer solutions [Turner and Guzonas]. The control parameter for alkalinity during at-power operation is the Li^+ concentration to ensure that measurements of alkalinity are reliable. At high temperature the OD^- (OH^-) concentration is directly related to the concentration of dissolved Li^+ because $LiOD$ ($LiOH$) is a strong base over the entire temperature range of interest and there is no boric acid. The concentration of OD^- (OH^-) controls the solubility behaviour of the HTS oxides.

The lower end of the Li^+ concentration specification is chosen to ensure a positive magnetite solubility dependence on temperature at all locations in the core, which keeps the core essentially free of deposits. There is a small amount of deposition on the inlet fuel bundles, but on-line refueling eventually shifts these inlet bundles further into the core, where the deposits dissolve at the higher temperatures. The data show that operation in H_2O with a pH (25°C) above 9.75, corresponding to a pH_a of about 10.2 (Li^+ concentration of 0.35 mg/kg) prevents deposition of corrosion products on fuel sheaths. The upper limit for pH_a was originally set to minimise carbon steel and Zircaloy corrosion, and to minimise activity transport. The discovery of flow-accelerated corrosion (FAC) of the carbon steel feeders at the outlet of the reactor core resulted in a decision to reduce the upper limit on pH_a [2] to 10.4. The majority of the dissolved iron in the PHWR HTS results from the FAC of the carbon steel feeders.

Based on extensive characterisation of reactor artefacts [Husain and Krasnai; Miller and Burrill; Semmler *et al.*] the fundamental principles underlying activity transport in PHWRs is now well understood and can be modelled. FAC of the carbon steel outlet feeders releases dissolved iron into the primary coolant; the dissolved iron precipitates in the steam generators and inlet piping once the coolant temperature drops in the steam generators to a value at which the solubility of magnetite is less than the coolant dissolved iron concentration. Inactive parent isotopes released by corrosion of the piping or by wear (e.g., antimony in Sb-impregnated graphite pump seals and bearings) deposit in-core by precipitation, particle deposition and/or adsorption (e.g., antimony), are neutron activated, and then released by corrosion or wear and transported from the core. Circulating radionuclides are incorporated, essentially irreversibly, into this constantly growing magnetite film, giving rise to out-of-core radiation fields. The overall process is illustrated in Figure 26.

Figure 26: Processes involved in PHWR activity transport [Guzonas, 2010]

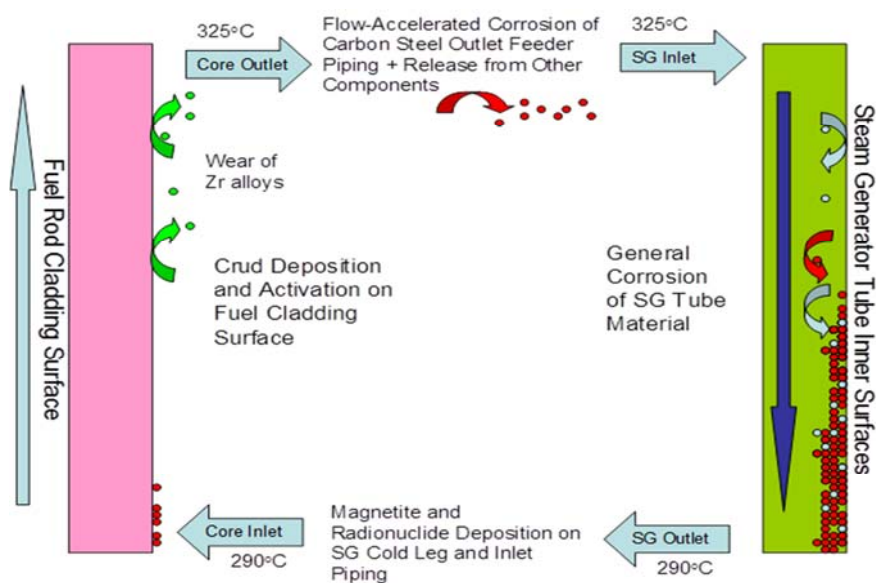

Radioantimony

Radioantimony contributes to radiation fields in CANDU stations mainly by acute releases due to Sb transients during shutdown. At the Canadian PHWR at Gentilly-2, acute release of ^{122}Sb and ^{124}Sb from in-core surfaces in the 1990s as a result of oxygen ingress during maintenance during shutdown adversely affected maintenance. At Gentilly-2, the antimony source was the site-specific use of Sb-impregnated carbon primary HTS pump seals and bearings.

Chronic build-up of radioantimony fields on out-of-core surfaces is limited due the short half-lives of ^{122}Sb and ^{124}Sb , and the limited production rate of ^{125}Sb in the absence of fuel defects. However, while ^{122}Sb has only a 3 d half-life, it had been present in significant quantities at Gentilly-2 prior to the removal of the Sb-impregnated carbon bearings and the routine use of an antimony removal process, and could take a week or more to decay to low levels, significantly affecting outage maintenance work. For example, in 1993, the out-of-core radiation fields rose from 0.5 mSv/hr (50 mR/h) to 2.50 mSv/hr (250 mR/h) due to an Sb excursion.

An oxidising antimony removal process developed by Siemens for PWRs was optimised for the CANDU HTS by Siemens, AECL and Gentilly-2 for the removal of in-core radioantimony [Dundar *et al.*]. The process was routinely used at Gentilly-2 at the start of each maintenance outage until the station was shut down. In this process, H_2O_2 is added to the HTS coolant during shutdown to create oxidising conditions in the coolant and force the mobilisation of in-core Sb. The Sb released is easily removed by anion exchange resin.

3.3.4.2 Purification

Main Heat Transfer Systems

The main HTS purification system designs used in different CANDU plants are similar in basic concept but differ in implementation; in particular, whether the system is pressurised or not, and the number of ion exchange columns. A small fraction of the HTS coolant flow is diverted through the purification system, cooled, and then passed through mechanical filters followed by ion-exchange columns. The purified coolant is then returned to the main HTS. The design evolved from the early Nuclear Power Demonstration (NPD) design through the Douglas Point Nuclear Generating Station (DPNGS) system, which incorporated some of the improvements suggested by the NPD experience, in particular the requirement that the purification half-life be as short as possible. Ultimately, a purification system with a 2 hour half-life was installed at DPNGS to control radiation field growth due to ^{60}Co . Recommendations were made to further reduce the purification half-life, and current CANDU 6 designs typically operate with a purification half-life of about 1 hour. CANDU plants with low pressure purification systems operate with longer purification half-lives.

Gentilly-2 was the first CANDU plant to implement the use of submicron filters based on successful operating experience in the US and Europe. Following this successful implementation, Darlington NGS began a programme to implement sub-micron filters, replacing the 1 μm filters in Unit 1 with 0.45 μm absolute filters in 2002 [Walker *et al.*, 2003]. Measurements during the Unit 1 outage 6 months after installation of the 0.45 μm filter revealed a 20% decrease in fields inside the vault, and the station realised a 6-rem dose saving during the outage. None of the concerns expressed by the station at the start of the programme (e.g., effectiveness, filter plugging, limitations for filter change-outs, and high differential pressure across the filters, purification system pressure increases, and future limitations for increasing purification flow) materialised. Since 2003/2004, DNGS moved to the use of a 0.1 μm filter as the in-service filter, with a 0.45 μm filter in the spare filter housing as a back-up. Wolsong Unit 1 changed the HTS purification filter cartridge from 6.0 μm absolute rating to 0.45 μm absolute rating in 2006 [Park, 2008]. The

^{58}Co concentration in the system decreased by 75% in the 19th plant outage as compared with the 14th outage and the ^{54}Mn and ^{95}Nb concentrations decreased by 9.8% and 6.2% respectively in the 19th outage compared with the 18th.

3.3.4.3 Fuelling Machine

As discussed in Chapter 3.2.3, one of the main sources of ^{59}Co in a PHWR is the Stellite™ load balls in the fuelling machines. Not all PHWRs have sufficient ion exchange capacity (some have none) in their fuelling machine purification circuits. Model calculations [Strikwerda *et al.*] suggest that, without ion exchange provisions, about 17 g/year of ^{59}Co enters the reactor system from each fuelling machine at the Darlington NGS. The majority of this cobalt is in particulate form with the balance being dissolved (in this case dissolved is defined operationally as any Co that passes through a filter of a particular mesh size). Most of the dissolved Co is generated from the surfaces of the ram balls, the remainder being from the surfaces of particles trapped on the filter. The potential reduction in cobalt ingress from ion exchange operation was estimated to be 21% or 3.5 g/year per fuelling machine. It was estimated that the net plant dose savings that would result from ion exchange operation over the period 2010 – 2022 would exceed 4.80 Sv, an installation of ion exchange purification capability in the heavy water auxiliary system was strongly recommended.

3.3.4.4 Hot Conditioning

Hot conditioning during reactor commissioning or after refurbishments is routinely used in PHWRs; [Venkateswarlu and Mathur, 1992], [Bose *et al.*, 2006]. One of the objectives of this preconditioning is to produce an adherent, uniform and protective coating of magnetite on the carbon steel surfaces to minimise corrosion during operation. Bose *et al.* [2006] noted that preconditioning also reduces activity transport during reactor start-up, minimising dose and minimises carbon steel corrosion in the interim period between light water commissioning and final commissioning in Indian PHWRs.

3.3.4.5 Zinc

The addition of zinc to the CANDU HTS was to reduce activity build-up and corrosion of system materials was extensively studied in the 1990s. Initial testing performed using carbon steel and 410 stainless steel showed that the reduction in ^{60}Co uptake was much greater for 410 SS (~25x) compared to carbon steel (~2x), consistent with observations from BWRs that the effect of Zn is greater for a chromite phase (e.g., inner oxide layer in BWRs) than a ferrite phase.

Since almost all of the iron deposited on HTS surfaces originates from FAC of the outlet feeders, the effect of zinc addition on carbon steel corrosion was assessed. Testing of 106B CS in the presence of 15 ppb Zn [Walker *et al.*, 1996] showed no effect of Zn on the corrosion rate within the experimental uncertainty.

Both Raman and Mössbauer spectroscopies indicated the incorporation of Zn into the corrosion layer on carbon steel results in the formation of zinc ferrite. It was not clear if oxide was composed of both stoichiometric zinc ferrite and magnetite or if the Zn was uniformly distributed throughout. It was found that the zinc ferrite layer formed in zinc-containing solutions dissolved in zinc-free solutions.

A significant negative effect was the measured decrease in the thermal conductivity of zinc ferrite (0.86 W/m°C) compared to that of magnetite (2.3 W/m°C) [Walker *et al.*, 1996]. Therefore, if all of the magnetite deposited in the SGs was converted to zinc ferrite, the thermal efficiency of the steam generators would be adversely affected.

Zinc addition to the CANDU HTS is currently not practised and is not recommended.

3.3.5 Boiling Water Reactors (BWRs)

The original state of chemistry that was sought in BWRs was pure water chemistry, now known as NWC (Normal Water Chemistry). The injection of various chemicals was introduced in order to improve performance within the areas of construction materials in the primary circuit and radiation environment. The major changes in BWR chemistry controls were to address material concerns, in addition to one or more of the transport and activation steps of the source term build-up:

- Corrosion of materials;
- transport of corrosion products to the core;
- activation of corrosion products;
- transport of activation products to out-of core surfaces;
- deposition of activation products on out-of core surfaces.

3.3.5.1 Purification

The removal of corrosion products is a basic step in the control of source term build-up, and it is in line with the original aim of BWR chemistry control – to achieve pure water chemistry. In a case where high concentrations of corrosion products are allowed to enter the reactor, the amount of activated corrosion products will increase due to deposition and activation on the fuel as crud, and the crud build-up process may also be affected adversely. Since the activated corrosion products are mainly incorporated in the fuel crud, a stable crud is preferable once it has been formed.

The in-flux of corrosion products to the reactor mainly arises from the feed water, especially in cases where forward pumping purification is applied, i.e. where a part of the feed water flow has not been passed through the condensate polishing plant. Corrosion of the turbine system may contribute several hundred kilograms of iron per year to the condensate⁴. This makes a properly functioning condensate polishing plant essential to achieve clean water chemistry.

To a lesser extent, corrosion products enter to the reactor coolant due to the corrosion of internal parts, fuel and other systems within the RCPB (Reactor Coolant Pressure Boundary). Once the corrosion products have reached the reactor, they will accumulate in the fuel crud, in the reactor water, on system surfaces and in the filters of the reactor water clean-up circuit. The corrosion products in the fuel crud become activated with time and contribute to the radioactive source term. With effective clean-up the concentration of corrosion products in the water and available for deposition will be reduced.

To enhance water purification the main tool is the optimisation of the condensate polishing plant and the reactor water clean-up circuit. Filter efficiency and the amount of water that passes the filters are key parameters even though increasing the flow rate or volume of flow would constitute major plant modification.

3.3.5.2 Iron

Purification for the removal of corrosion products can, in some cases, results in very low feed water concentrations of iron. EPRI recommends a feed water iron concentration

4. This can be shown by multiplying the iron concentration of the condensate (typically 10-20 ppb) with the condensate flow (typically 1.000–1.500 kg/s) and a time period of one year.

of 0.1–1 ppb in order to meet fuel performance requirements, but a part of the international BWR fleet is at levels well below 0.01 ppb [22]. At such low concentrations it can be expected that an activated corrosion product such as ^{58}Co (activated from ^{58}Ni) and ^{60}Co will not be retained as well in the fuel crud as otherwise.

Iron injection has been utilised in for example Japan and Sweden. The purpose has been to raise the reactor water iron concentration to allow it to affect crud formation and thus also the reactor water concentration of cobalt isotopes. The means to inject iron require some consideration. Methods that have been used include the injection of a solution into the feed water, purposely degrading the function of the condensate polishing plant, or passive addition of iron through controlled corrosion [23].

3.3.5.3 Zinc

Zinc can be added to the feed water to limit the source term build-up. Ideally, the zinc will prevent incorporation of cobalt into the oxide films on system surfaces as well as on the surface of the fuel bundles. The zinc will thus reduce both the activation of cobalt and the subsequent migration into systems of any ^{60}Co still produced. The concentration of ^{60}Co in the reactor coolant is also expected to become lower over time since the amount of activation is reduced.

Zinc injection needs to be supervised with care. The amount of zinc that is injected needs to be balanced and determined for each plant that intends to use it. The target concentration of zinc in the reactor coolant is often in the range of 3–10 ppb [24]. The proper amount is estimated from a combination of experience, ^{60}Co concentration and iron concentration. Also, the zinc injection must be continuous in order to have the intended effect as the effect on the cobalt uptake on system surfaces has been shown to respond quickly to changes in reactor water chemistry [25].

The zinc injection can be done using either natural or depleted zinc oxide (NZO or DZO). The drawback of NZO is the activation of ^{64}Zn to ^{65}Zn , affecting the radiation source term.

3.3.5.4 ECP Control

The most important connection between reactor chemistry and construction materials is corrosion that can be seen as the result of the chemical or electrochemical reactions of the material. The corrosion of metallic construction materials can be divided into common and local corrosion. The common corrosion takes place evenly over large surfaces and increases the amount of corrosion products in the water and on core and system surfaces. Local corrosion, mainly in the form of stress corrosion cracking, instead threatens the integrity of the RCPB.

Stress corrosion cracking can appear in transgranular or intergranular form. Intergranular stress corrosion cracking (IGSCC) is considered the most important form of corrosion with regard to RCPB integrity. IGSCC requires the presence of oxygen or hydrogen peroxide. With hydrogen injection to the feedwater, HWC (Hydrogen Water Chemistry) can be achieved. The purpose of the addition of hydrogen is to recombine with the oxygen and hydrogen peroxide formed by water radiolysis to reform water, thus removing the harmful species and reducing the ECP (electrochemical corrosion potential).

The purpose of HWC is to counteract IGSCC but the radioactive source term will likely be affected as HWC is introduced. It has been shown that as the chemistry is adjusted from NWC to HWC (or the opposite) the fuel crud will rearrange its structure in such a way that a considerable amount of ^{60}Co may be released into the reactor water and also likely deposit onto system surfaces [26]. In order to minimise the negative impact on the radioactive source term, any unnecessary cycling between oxidising and reducing

conditions should be avoided. Also, the system surface uptake of cobalt isotopes can be mitigated with zinc injection in such situations [25, 26].

It has become increasingly more common to combine hydrogen injection with the injection of noble metals. This can be done either by a single addition (which may later be repeated) or on-line. The purpose of the noble metals is to catalyse the recombination reactions between hydrogen, oxygen and hydrogen peroxide. The resulting ECP becomes very low and causes the outer part of the oxide layer to dissolve. The remaining thin oxide layer has the ability to incorporate cobalt to a large extent /ISH05, EPR08/. This, again, can be mitigated well with a balanced zinc injection programme [22].

A novel approach to ECP control is the use of surface deposition of TiO₂. As TiO₂ is subjected to UV radiation (supplied as Cerenkov radiation from the reactor core) water near the surface will be oxidised. In this manner an anode current through the material is supplied, instead of the same thing happening due to the oxidation of the metal of the construction material [27, 28].

3.4. Remediation of Contamination during Outages

Remediation includes full system decontamination, system/component decontamination, flushing, and hydrolasing of components. Section 3.4 basically reviews these processes.

3.4.1 Full system decontamination

Decontamination

An evaluation of BWR full system decontaminations (FSD) was performed by EPRI in 1992 [29]. At that time, eleven different reactors had experience with full system decontamination. One reactor had had the equivalent of 15 FSDs, five with a Citrox type process and ten with LOMI⁵. Additional techniques (OPP, OPG, phosphoric acid, oxalic acid, ammonium citrate, CAN-DECON, AP, and NP) have been employed at other reactors. None of these decontaminations at that time had produced any serious problem during the decontamination or during subsequent service.

Base on this positive experience and the rigorous corrosion testing performed with the LOMI process on BWR structural materials, it is concluded that the LOMI process could be safely applied to the full system of the BWR. The sole PWR FSD in the USA was performed at Indian Point 2 in 1995 with the AP/CAN-DEREM process [30]. Recently, the BWR Owner's Group has undertaken an evaluation to implement full system decontamination with fuel in the core.

AREVA has developed FSD process called HP/CORD® UV (Chemical Oxidation Reduction Decontamination). HP/CORD UV represents a regenerative multicycle decontamination process. As first step the oxide layer containing radionuclides are oxidative treated with Permanganic acid (HMnO₄; "HP"). After the reduction step, the corrosion products and the radionuclides are chemical dissolved. During the regenerative process the corrosion products and radionuclides are transferred on ion exchange resins. At the end of the decontamination cycle Oxalic acid as decontamination chemical, is decomposed photo catalytically to CO₂ and H₂O. This process was successfully applied at several operating PWRs and BWRs in Europe and Japan with DF in the range 10-1.000 [31].

Above mentioned process has been further improved in order to minimise recontamination and it was successfully applied at German NPP Grafenrheinfeld in year 2010. This concept consists of passivation in hot subcritical conditions with pH_(T) as high as possible for the given limits and constraints, injection of Zinc as soon as possible use

5. U.S. Patent 4,705,573.

of fresh resins and maximal clean-up flow and steady power operation for three months after start-up. Following such a treatment dose rates remain at the level of 30% after two years of operation [32].

Full system decontamination was applied at NPP Loviisa-2 in 1994 in order to minimise dose rates of coming long outage. In this case, a Siemens developed CORD/UV process with mobile AMDA equipment was applied. Reactor was defueled before decontamination and solution was circulated with MCPs. Very good DF values were achieved – 150 inside SGs, 12 for hot leg and 10 for cold leg of primary loop and through this decontamination more than 8 man/Sv of doses was saved [33]. Effect of decontamination at loop surface activities is demonstrated at Figure 27. Nevertheless increased core deposits appeared during next cycle leading to numerous fuel failures [34].

Figure 27: Average contamination levels on the 1st loop of Loviisa 2 (8 points). In 1994 and 1995 the MARC measurements were made twice to follow-up the decontamination and recontamination.

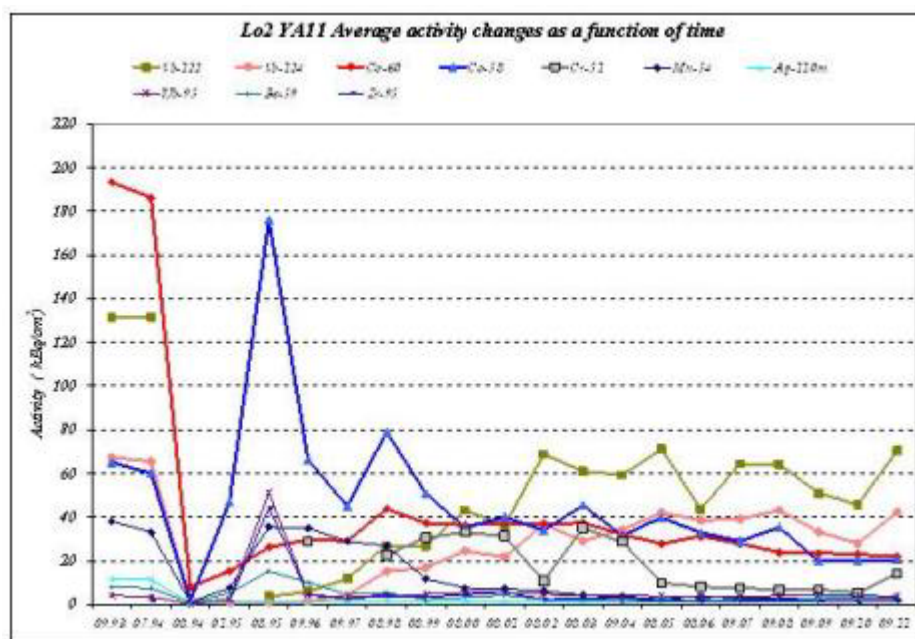

3.4.2 System and component decontamination

For PWRs and BWRs, already mentioned AREVAs process HP/CORD® UV has been also successfully applied worldwide with results similar to those mentioned for FSD. For VVER type reactors decontamination of main primary components is performed to assure favourable radiation conditions and surface status for repair and inspection works. Typically main coolant pumps, main gate valves and control rod drives are components decontaminated during outage. Specific component represents steam generator due to his horizontal configuration and large surface. Several manipulators have been developed for this purpose and typically AP CitroX process was applied. This approach has several drawbacks. At first, there is a high surface-to-volume ratio so iron solution becomes saturated and iron oxalate precipitate is formed and deposited in the tubes due to low velocity during circulation and post decontamination flushing. Second negative impact is that the surface after decontamination remains in corrosionally active state and during subsequent operation generates increased amount of corrosion products. These corrosion products together with deposited iron oxalate represent high risk for increased fuel deposits formation.

Experience from several plants showed that if more than half of steam generators (e.g. 4 SG of 6 at VVER-440) had been decontaminated, this led to elevated deposit formation on the fuel with unacceptable core power distribution inhomogeneities (which can be considered as a kind of CIPS effect on the VVERs) and also to high dose rates during next outages after redistribution of in-core deposits within out of core primary system surfaces [35].

Effect of decontamination to the surface activity of SG tubes is demonstrated at Figures 28 and 29, where two steam generators of NPP Loviisa-1 are compared.

Figure 28: Trending of the activity concentration on the 1st SG hot side on LO1 not ever decontaminated

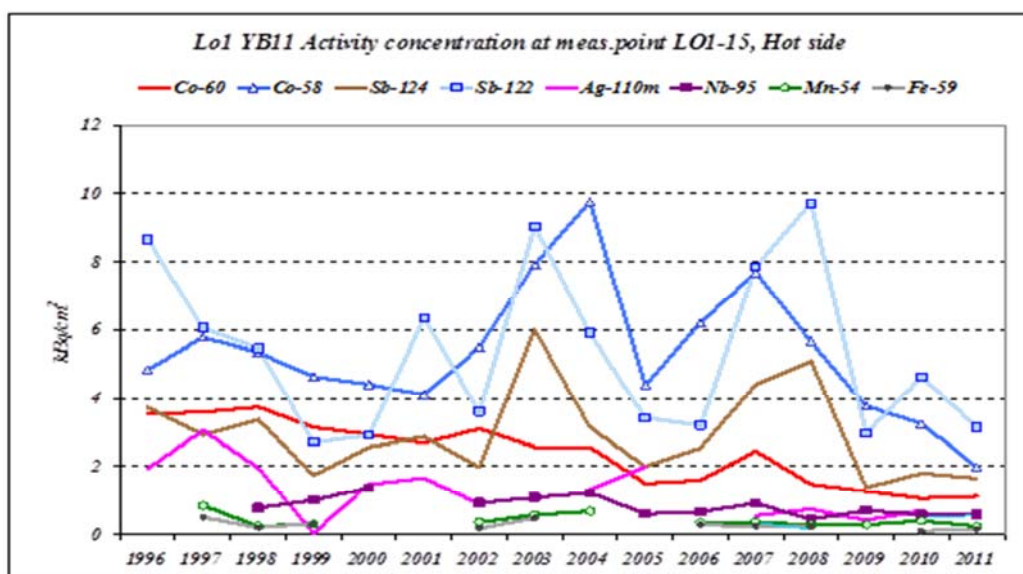
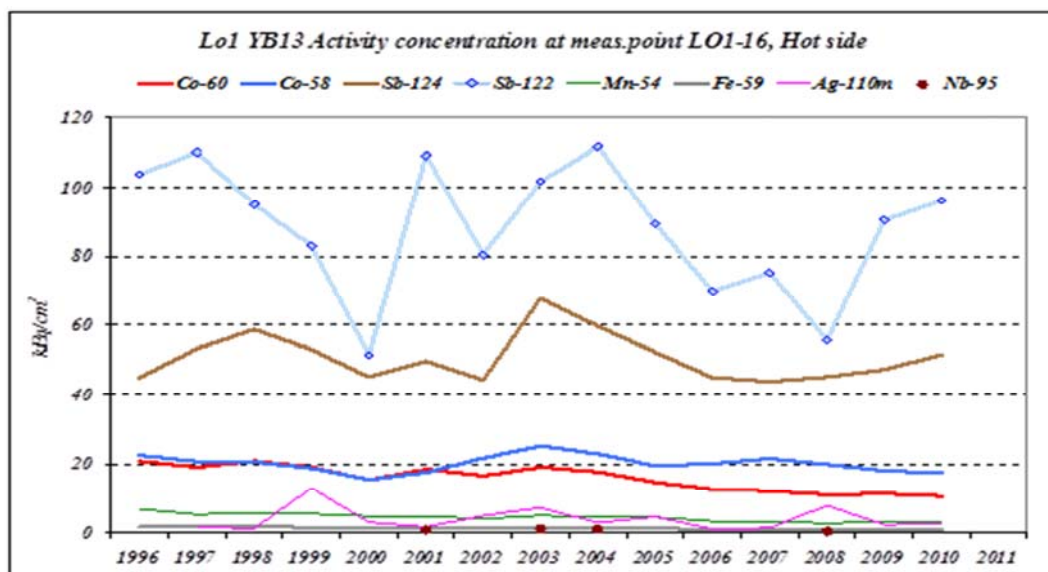

Figure 29: Trending of the activity concentration on the 3rd SG hot side on LO1 decontaminated in 1980. The concentration of Co is slightly lower than on the surface of the loops, but the concentration of Sb slightly higher.



The number of decontamination operations carried out by EDF on medium or large size components has regularly increased for these last 20 years. These operations are carried out on some parts of the primary pipes during replacement of steam generator, on hydraulic parts of primary pumps and CVCS exchangers, filters and pumps. To implement these operations, EDF has been developing over the years three soft chemical decontamination processes used according to the characterisation of the contamination:

- EMMAC is used for dissolution of Ni, Cr, Fe oxides without presence of Stellites.
- EMMAC POA is used for dissolution of Ni, Cr, Fe oxides with presence of Stellites.
- EMMAg is used for for dissolution of Ni, Cr, Fe oxides with supplementary Ag pollution with presence of Stellites.

The optimisation of these chemical decontamination processes are in progress at EDF with a view to decrease the application time and the volume of generated effluents.

For each PWR concerned, studies begin with a diagnosis of the origins of contamination, the type of pollution, its form (mobile hot spots, oxide layers) and its localisation. According to these results, EDF decides to implement the most adapted decontamination process (mechanical or chemical), estimates the Dose Rate Reactor Factor (DRRF) for each possible decontamination scenario and assesses the dosimetric gain (3D local modeling) in order to find out if the operation is profitable or not. The average dose gain is estimated to 0.5 man.mSv per reactor for the five following years.

3.4.3 Others

Dilute chemical decontamination

Dilute chemical decontamination (DCD) of subsystems and components of operational nuclear power plants is a mature, well-established technology. Since the first such application in 1979, the industry had grown to the point where about 10 decontaminations are performed each year in the USA in 1999 even though this has dropped to less than three per year over the last five years. EPRI has provided a handbook on the application of this technology that describes in detail the methods and also provides utility application information [36].

DCD is, in part, responsible for the average radiation dose per reactor being reduced from about 10 Sv for BWRs and about 6 Sv for PWRs in the early 1980s, to about 1 Sv per reactor in 1998. Three DCD processes have been employed for the vast majority of these decontaminations. They are:

1. LOMI (used for 46% of all USA operational decontaminations since 1990, and essentially 100% of the BWR recirculation piping decontaminations).
2. CITROX (36%).
3. CAN-DEREM (18%).

These processes bring about decontamination by dissolving the deposits found on the interior surfaces of pumps, valves, pipes, heat exchangers, etc., and releasing the entrapped radionuclides that are responsible for the external radiation fields. All solubilised material is removed from solution by ion exchange resin. The resin is transferred to high integrity containers (HICs), dewatered, and transported to a licensed radioactive waste disposal site for burial.

These processes will dissolve most iron and nickel-based deposits found in LWRs, but are ineffective on high-chromium deposits such as those found in PWRs and BWRs operating under hydrogen water chemistry (HWC). To dissolve such deposits, the chromium must first be removed. This is done with an oxidising step based on the use of

potassium permanganate. Potassium permanganate oxidises the chromium in the deposit from the insoluble +3 valence state to the highly soluble +6 valence state. Once the chromium is removed, the decontamination process is applied as described above. Two dilute chemical oxidising processes have been developed – alkaline permanganate (AP), and nitric permanganate (NP).

Four plants that are permanently shut down were decontaminated in 1998. To reduce radiation exposure ALARA during decommissioning, management personnel at three of the plants elected to perform chemical decontaminations of all major systems prior to the start of major decommissioning activities. Selective subsystems were decontaminated at the fourth. Higher levels of radioactivity removal are required than for operational-type decontaminations. While a decontamination factor (DF) of 10 is generally considered adequate for operating plants, a target DF of 100 or more is not unreasonable for decontamination prior to decommissioning. To achieve such a high DF, removal of a thin layer of underlying base metal is required in addition to removal of the oxide film. Operational-type process is, by design, too “mild”. They have been specifically developed not to remove base metal. Two new processes have recently appeared on the market that are designed to remove a small amount of base metal and give the high DFs required for decontamination prior to decommissioning. They are the DFD process developed by EPRI, and the CORD D UV process developed by Siemens. Both are described in detail in the EPRI Decontamination Handbook [36]. The four applications, three with EPRI DFD and one with CORD, are reviewed.

The effect on decontamination of zinc addition to BWRs is discussed. No effect on the ability of the operational DCD processes to achieve the required DF has been observed with the addition of zinc to the BWR coolant [36]. The impact of hydrogen water chemistry has also been evaluated, and it has been found that the oxide film in plants on HWC is converted to a high-chromium film similar to that found in PWRs. The film also contains a high proportion of nickel ferrite. The NP/LOMI process is very effective on films of this type. There is also evidence that the HP/CORD process is effective on HWC films.

Generally, ion exchange resins from decontaminations are dewatered in a high integrity container (HIC) and buried at a licensed radioactive waste disposal facility. The potential exists for creating a mixed waste due to the presence of chromium. However, all wastes to date have passed the toxic characteristic leach procedure (TCLP) and thus are classified as non-hazardous. The potential also exists for creating a waste form that is greater than Class C due to the presence of transuranic (TRU) radionuclides. Such a waste form would be unacceptable for burial at any currently available site. In plants with TRU as the result of fuel failures, the ion exchange resin is taken off line during the decontamination based on TRU loading as opposed to chemical loading. This usually generates more waste, but none of it is greater than Class C [36].

Mechanical flushing

In some cases, mechanical flushing is practiced to remove hot spots on piping runs and tanks. Typically, taps are installed near an elbow or long run of piping prone to CRUD traps. A hydro blaster (or sludge lancer) is employed to provide a 2.000–4.000 psi stream of portable water to the pipe to mechanically flush the source term to the radioactive waste system.

Demineraliser vessels are important to mechanically flush to remove “heels” of old resin that often collect in the bottom of flat bottom vessels. It is recommended to mechanically flush vessels every 5-8 years. Conical bottom vessels may reduce the development of old resin heels but this need to be verified by the insert of a light scope or other visual means. In addition, it is recommended that a visual inspection of the vessel screens be done every 5 years. There have been documented failures of screen failures

which have forced reactors to shutdown down due to resin intrusion, and high sulfates in the RCS.

On BWRs, mechanical flushing is practiced to remove the ^{60}Co build-up on the outlet piping to the vessel prior to ISI (non-destructive weld testing) on the piping in the drywell. The hydro blaster is lowered from the refuelling bridge to each vessel exit piping. An underwater camera is also used to properly position the water flush.

Portable purification

This section describes the Portable Underwater Demineralised employed at Seabrook Station with lesson learned

- Seabrook is designed with an installed cavity purification system (~100 gpm) through skimmers and CVCS mixed bed demineraliser with return to the cavity via RHR. Many times the installed system has been unavailable in outages because of valve work. This led us to seek an alternate portable system. There were already commercially available submersible systems available from Trinuke but we struggled with the concept of removing either the resin from the demineraliser or a spent demineraliser from containment in the outage (Figure 27).
- Seabrook RP staff conceptualised a submersible demineraliser with tri-nuclear that has multiple small demineraliser units which fit in our transfer system (Figure 28).
- Filter and demineraliser housings are permanently stored in the lower cavity.
- The Reactor Cavity Demin System (Model RCDS-120) is a portable underwater demineraliser system designed to clean up the Reactor Cavity water during refuelling outages.
- The RCDS-120 system consists of a base unit that can hold eight (8) 8" OD x 7ft long demineraliser columns (Model RCD-7), a submersible pump (Model PP-120/5SC), and a standard Tri Nuclear filter housing.
- When the outage is over, the demineraliser columns can be transferred to the SFP via the fuel up-ender, the pump and strainer are removed and the base can be left in the cavity during power operations.
- The Reactor Cavity Demineraliser System is utilised during refueling outages to purify cavity water, reduce activity and improve water clarity.
 1. Reduces personnel exposure.
 2. Limits personnel contamination.
 3. Helps prevent errors during fuel movement.

Reactor Cavity Demineraliser Components (Figure 30):

- RDGS-120 Base.
- Submersible Pump Assembly.
- Flow Meter and Sensor.
- RCD-7 Demineraliser column.
- Control Panel.
- Strainer Basket.
- RCD-7 Floor Storage Rack.

Figure 30: Seabrook Submersable Tri Nuclear Demineraliser

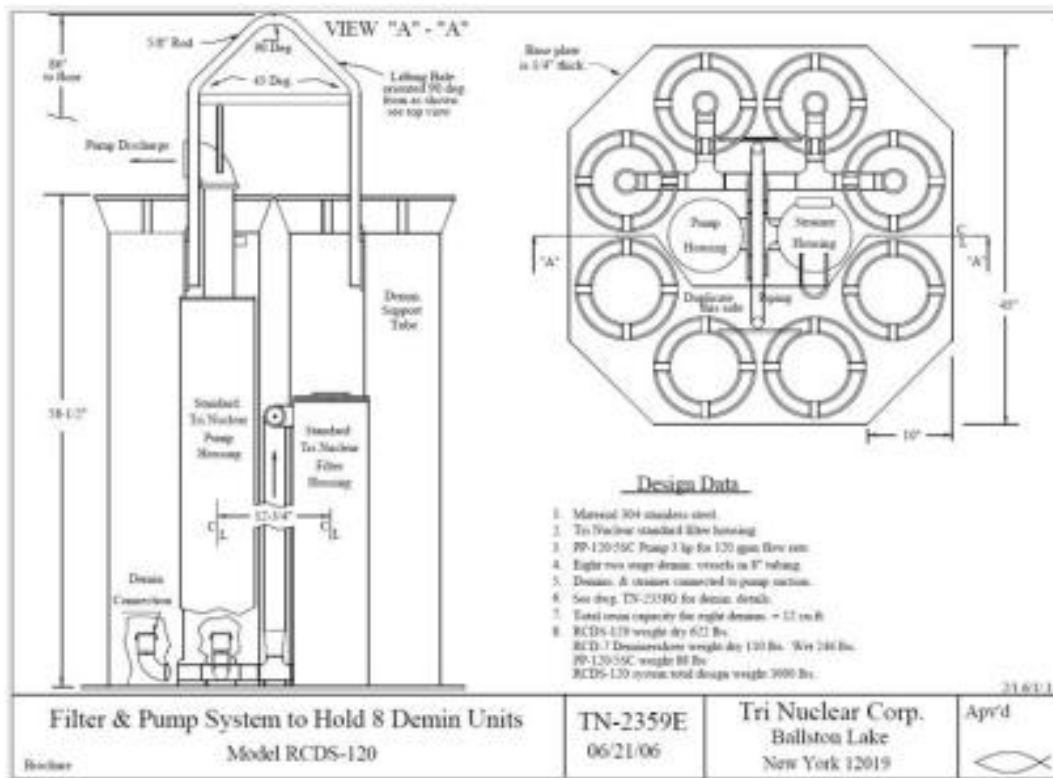

Figure 31: Tri Nuclear Submersable Demineraliser Configuration

The base plate is 45" square (with 10" cut back on each corner), 86" tall (to the top of the lift bale) and weighs 622# dry.



- Then the observed dose rate band near the top of the individual resin columns indicates that the resin was not exhausted. For the resin to be exhausted, the higher dose rate bands would be expected to occur near the bottom of the resin columns.
- This demineraliser unit is credited with the removal of an estimated nine Curies of soluble gamma activity during OR11 when the station observed dose rates over the refuelling cavity lower than previously experienced. While the submersible demineraliser is not the only factor contributing to the favourable dose rates over the refuelling cavity, the soluble activity removed from the cavity combined with the remote transfer design contributed to our exceptional OR11 ALARA performance. Because of rigging problems, the system was not used in OR12. However the system was used again in OR13 and OR14 with resin loadings modified each outage to better target colloidal cobalt species. Table 12 summarises the submersible demineraliser system loading.

Table 12: Resins Loading on Underwater Demineraliser at Seabrook Station

Outage	Cavity Flood-up Activity, uCi/ml	Resin Load	Calculated Activity Removed, Ci (MBq)
OR11	3.58E-03	8% Crosslink Gel Cation (GR 2-0)	6
OR13	1.01E-02	Macroporus Anion (NRW 501P) over Macroporous Cation (NRW 160) over 8% Gel Caation (GR 2-0)	14
OR14	8.25E-03	Macroporous Cation (NRW 160) over Macroporous Anion (NRW 507)	27

4. Radiation Field Measurement Techniques

The effect of the radioactive source term on the radiation environment inside a plant is mainly due to radioactivity that has been deposited on system surfaces. The radiation environment can be analysed in a number of ways where the simplest method would be the follow-up of occupational exposure, such as through ISOE database. With some further effort a more detailed mapping of radiation fields can be done, both with regard to quantity (number of measurement and measurement points) and quality (precision of measurements, proper selection of measurement points, radionuclide specific information versus dose rate etc.).

4.1 Dose Rate Measurement Techniques

Radiation Field Sources and Interferences

The primary contributors to out-of-core radiation fields in western PWRs and BWRs have been identified as ^{58}Co and ^{60}Co . The majority of this activity is incorporated into the oxide film of the out-of-core surfaces through soluble oxide growth, with the balance of the activity deposited as particulate activity. Gamma ray spectroscopy measurements of the reactor coolant loop piping have shown that these two radionuclides generally control shutdown dose rates [37].

Because the half-life of ^{58}Co (70.8 days) is relatively short in comparison to that of ^{60}Co (5.3 years), the time elapsed between the plant shutdown and survey dates can have an impact on the measured radiation fields as the ^{58}Co and other short lived isotopes decay. This is especially important in PWRs where ^{58}Co activity is a large fraction of the total activity compared to BWRs where ^{60}Co is predominant. Procedures should be defined to take measurements within 24 hours after completion of the forced oxidation clean-up.

Proper selection of survey instrumentation is important to provide accurate dose rate readings at the intended measurement locations. Localised high radiation areas or hot spots located near a survey location can also influence the radiation field measurements. Examples of such hot spots in PWRs are drain lines, the regenerative heat exchanger, and resistance temperature detector (RTD) manifolds, valves, and associated piping. Dose rate surveys should be taken using a detector with directional bias response in order to accurately measure contact dose rates on each specific component and to reduce the impact on the reading from extraneous background radiation and contributions from nearby components.

Instrumentation

Examination of the radiation field data across large fleets of units shows that significant variations can exist in the data measured at the same location but on different occasions [37]. To effectively present the plant radiation fields trends, the factors that influence the data must be identified, quantified, and considered. These factors can include the source strength, attenuation effects, and instrumentation utilised.

Unfortunately, many historical data do not have adequate descriptions of the attenuation and instrumentation effects; the data were often presented as tables of values without qualification information [37].

There are a variety of radiation measurement devices available to the industry; however, most are either Geiger-Muller tubes or Ion Chambers that are calibrated to known sources.

Data have variously been collected using TLD (Thermo-Luminescent Dosimeter), non-directional surveys meters (e.g., ion chambers), and 'homemade' directional detectors (GM detectors wrapped in lead). Many utilities have also chosen to use Electronic Dosimeters (EDs) because they conveniently interface with plant data collection systems. They are ion chamber detectors, except they often have an electronic bias programmed for conservatism. These data are corrected if the bias is known.

The survey instrumentation used and the procedures applied by the technician are not universally consistent among the plants, which can contribute to difficulty in making comparisons. At a given plant, a non-directional instrument will generally result in dose rate readings higher than the actual contact measurements of interest and will likely contribute to greater variability in the readings taken during different outages.

EDF measurement devices are radiation meters usually fitted with an energy-compensated GM (Geiger-Mueller) type gas detector. Their measuring range is variable and depends on the aims of use. For mapping incorporating the hot spots, the range lies between a few micro Sieverts per hour and a few sieverts per hour. The energy domain covered ranges from 60keV to several MeV, integrating ⁶⁰Co gamma rays (1.115MeV and 1.233MeV). Response at high gamma energies, such as those of nitrogen 16 close to 6MeV, is characterised in order to assess the efficiency of the biological protection devices that are going to be installed around the hot spots in the reactor coolant system.

From a purely practical operational point of view, according to the design basis of the detectors, EDF favours the use of radiation meters with a small detector for assessing dose rates at the hot spots. Indeed, the advantage of having devices with small GM detector is that this limits the gamma flux gradients, enabling measurements to be taken using a detector positioned in a homogeneous flux, which will not be the case for large volume detectors, which will tend to underestimate the value of the hot spot. In any event, this type of measurement requires the use of the same type of device in order to ensure that measurement may be reproduced. Given the uncertainty of these measurements, best practice involves taking a measurement on contact combined with a measurement taken at a suitable distance, so as to establish conditions that are

consistent and representative of the actual risks faced by operators. EDF has chosen to take measurements at a distance of 1m and 50cm. These measurements enable the room's zoning to be characterised.

Certain site best practices also enable changes in the dose rates of hot spots in the reactor coolant system to be monitored (measurement using gamma radiation monitors positioned close to the hot spot to be monitored and connected to an RP SUPERVISOR located outside the zone) or even to record these changes on a specific radiation meter during operating processes, which allows accurate estimation of the purification of the coolant systems during the unit shut down phases. This means that dosimetric gains can be optimised on line with the duration of filtering of the primary coolant, which contains radioactive impurities that may contribute to a higher dose rate at the hot spots.

The good working order and calibration of these devices are checked regularly, at least once per year. The calibration and all the functions of the radiation meters are fully checked at least once every three years, as recommended by French regulations'.

Remote Electronic Dosimetry

Plants generally have electronic dosimeters installed at various locations in the plant. Those locations can be categorised as being installed either on piping or in general areas. This distinction is made because measurements can reflect distinctly different ways of assessing radiation fields.

Measurements on piping are typically dominated by the activity in the coolant inside the piping. This makes such measurements less directly linked to personnel exposure, since, for example, piping with high activity coolant could be well shielded or personnel could be kept out of the area at times when coolant activity is high. Nonetheless this data is important as these time dependent dose rates on piping are more closely linked with operations and chemistry modifications made to mitigate radiation fields.

General area measurements, on the other hand provide a much more direct indication of potential personnel exposure, if the jobs under consideration require working in the area measured. However, it is possible that such measurements are significantly influenced by local hot spots and are not a good measure of the efficacy of efforts to reduce out-of-core radiation fields.

4.2 Germanium Detectors

The semiconductor detector, or more specifically the high purity germanium detector, offers the highest energy resolution of all the commercially available detector alternatives. This allows for radionuclide specific measurements of gamma radiation where all the sufficiently gamma emitting radionuclides can be separated and identified. Furthermore, the germanium detector is an established tool and it offers good stability and precision. The knowledge of precise and radionuclide specific levels of contamination in the pipes and heat exchangers of the RCPB allows for trending and analysis of the development, as well as analysis of the causes of the contamination.

The drawbacks of the germanium detector as a mobile tool are due to practical issues:

The detector requires constant cooling that is most often supplied by a small liquid nitrogen Dewar vessel that needs to be filled repeatedly during a measurement campaign (typically every 1–3 days). Electrical cooling could be considered provided that cooling is not interrupted as the detector is moved between measurement points and electricity outlets.

The measurement times are longer than for a gross dose rate measurement. A measurement with a collimated germanium detector can require measurements times counted in hours.

The setup is rather cumbersome to move due to the heavy shielding that is required for the detector.

This device allows non-destructive surface activity by gamma spectrometry (HP germanium detector cooled by liquid nitrogen) based on a photon flux measurement converted in activity with the help of a measured or pre-computed transfer function (MCNP, MERCURE or PANTHERE codes for example). A very large range of geometries can be measured as primary circuit (cold and hot side steam generator tube bundle, hot, cold and cross-over legs), CVCS (let-down line, regenerative heat exchangers), RHRS (heat exchanger, piping), ...

The measurement can be performed on the primary circuit if full or empty, because the volume activity contribution can be removed. That point can be important in case of a high volume activity in the primary coolant that can notably affect the measurement result and lead consequently to a wrong analysis.

Deposited activities can be measured in a range from 1 MBq/m² to 100 GBq/m² with a counting time depending on the detection accuracy: 30 minutes for current high activity radionuclides (⁶⁰Co, ⁵⁸Co) up to 1 hour for the other ones.

4.3 CZT Detectors

This real time acquisition device allows the identification of 10 main radionuclides likely to be found in NPPs (⁵⁸Co, ⁶⁰Co, ^{110m}Ag, ¹²⁴Sb, ¹²²Sb, ⁵¹Cr, ⁵⁹Fe, ⁵⁴Mn, ¹³¹I and ¹³⁷Cs) and the determination of the radionuclide relative contribution to outside pipe wall dose rates. The dose rates conversion into deposited activity is also possible thanks to a transfer function (code calculation) but very limited due to an incomplete geometry set on one hand and to the necessity to perform the measurement with an extremely low volume activity on the other hand. The CZT gamma spectrometer principle is reminded in Figure 34.

Figure 34: CZT principle diagram

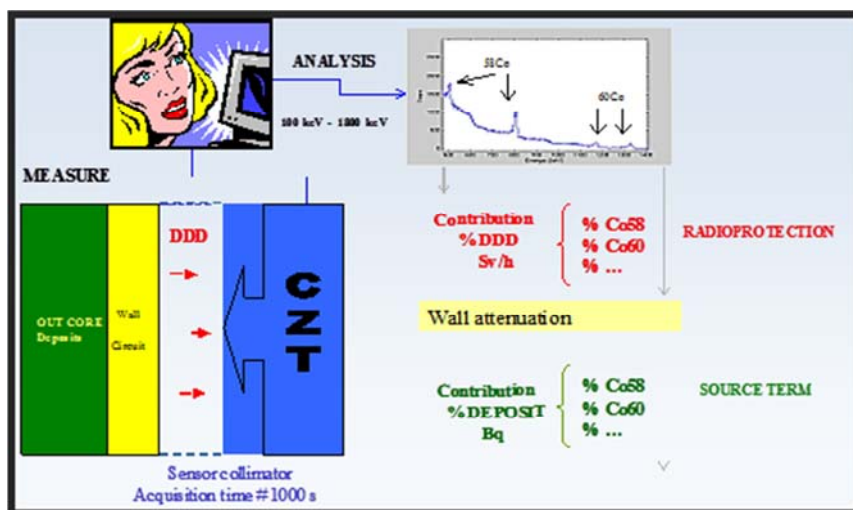

The equipment is shipped with 3 interchangeable CZT probes of varying sensitivity:

- 60 mm³: 0.5 mGy/h – 10 mGy/h;
- 20 mm³: 5 mGy/h – 100 mGy/h;
- 5 mm³: 20 mGy/h – 150 mGy/h.

The gamma energy spectrum ranges from 100 to 1.800 keV for exposures from 0.5 to 150 mGy/h, depending on the used probe. The spectral resolution is from 15 keV (at 600 keV) up to 25 keV (at 1.300 keV). Approximately 15 minutes is necessary for the acquisition of a spectrum with an exposure of 1 mGy/h, without any probe collimator. The first feedback analysis (comparison with EMECC more accurate but also more difficult to handle) shows that the CZT device is able to satisfactorily quantify the main radionuclide contribution to equivalent dose rate.

The spectral resolution of the CZT detector is greater than that of NaI and less than that of ultra-pure Ge and meets industrial requirements for radiation protection issues.

4.4 Comparison between High Purity Germanium and CZT

Table-13 summarises the characteristics of a germanium to a CZT detector. Both of these detectors are applied in the industry and Table-12 provides a quick overview of technical specification and comparisons.

Table 13: High Purity Germanium to CZT detectors

Characteristic	HP Germanium	CZT
Output	Radionuclide contribution to deposited activity	Radionuclide contribution to dose rates
Resolution	Less than 3 keV (at 1.3 MeV)	From 15 keV (at 600 keV) to 25 keV (at 1.3 MeV)
Background Limitations	From 2 µGy/hr to 2 mGy/Hr	From 0.5 mGy/h to 150 mGy/h
Activity Measurement Range	From 1 MBq/m ² to 100 GBq/m ²	Not Yet Applicable
Energy range	From 10 keV to 5 MeV	From 100 keV to 1.8 MeV
Acquisition time	2 hours	15 minutes
Work requirements	Very heavy device Liquid Nitrogen cooling Collimator needed	Very easy to handle No liquid Nitrogen cooling
Nuclide Identification	Most gamma emitters	Limited by resolution

5. Measurement Locations and Indices

There are several key aspects to be considered for source term tracking mechanisms. These factors should be developed for specific plant and included in plant procedures. These factors are as follows:

- Survey locations – the points should be identified and remain consistent over time. The points should be selected based on accessibility and associated systems. This enables better tracking and trending of source term over time. Consideration should be given to providing a form of unique identifier of the survey location.
- Time after shutdown – where possible, the time the surveys are taken after shutdown should be consistent. This minimises any error due to decay corrections for short lived radionuclides.
- Instrumentation – consider the limitations of the instrument and where possible use the same instrument over time to reduce the influence of instrument errors.

- Survey conditions – for greatest accuracy the condition of the survey location should be noted with special attention to the following which can influence survey results:
 - Insulation present and thickness.
 - Pipe wall thickness.
 - System full of water or drained.

These are a few of the key items to consider and the following approaches are example methods of how these can be addressed.

5.1. Pressurised Water Reactors (PWRs)

5.1.1 EDF methodology

Reactor Coolant System (RCS) Index

This historical RCS index, carried out on the French fleet since the start-up of all units, is adapted from the SRMP measurement programme proposed by EPRI⁶. This programme contains 3 points per loop located on hot leg, cold leg and cross-over leg (Figure 35). The RCS index is calculated as the average over 9 points for a 900-series unit (3 points × 3 loops) or over 12 points for a 1.300-series unit (3 points × 4 loops). RP department performs these measurements before oxygenation (internal EDF procedures). Post oxygenation measurements are optional if required for source-term measurements.

Figure 35: Localisation of RCS index measurement points

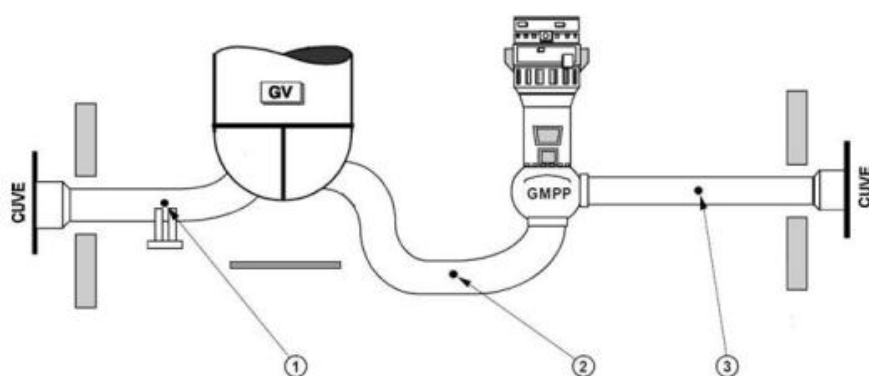

Reactor building index

Management of source term is a key element of any ALARA action plan. Important efforts have been undertaken at the beginning of the 2000s so as to clean up reactors showing highest collective dose due to numerous hot spots and contamination issues. Following these dedicated actions, it has appeared that a tool for the detailed follow-up of reactor state of cleanness in order to detect long-term trends for the overall facility radiological state as well as for single system was missing.

RCS index, followed since the first start-up of each French NPPs, is particularly useful to compare the dose rates near primary pipes between several units but does not give any information about the fleet radiological state of the reactor building.

6. Application of the EPRI Standard Radiation Monitoring Program for PWR Radiation Field Reduction. EPRI Palo Alto, CA: 2007. 1015119.

Based on this, an index of the radiological state of the reactor building has been developed and experienced on all EDF nuclear plants between 2010 and 2011. This index, which is mainly based on a similar tool that has been experienced for more than 10 years at the Blayais NPP, provides an average ambient dose rate (taken at 50 cm or 1 m from the measured point) on the different levels of the reactor building. This average value is based on cartography with approximately 50 measurement points. It has been developed for the various sister units of the fleet and allow the following of the radiological state of the reactor building as a whole and the main systems (RHRS, CVCS, RCS, VDS, PZR, SIS, Steam Generator and RFCTS – Reactor and Fuel pools Cooling and Treatment System).

In order to be able to compare this index between the different reactors and within the same plant for different times, the mapping must be achieved in the same conditions on all the fleet and for each shutdown. It is thus requested to perform the mapping just after the shutdowns of the reactor building so as to follow the real state of the systems due to the operation.

As an example, Figure 36 shows the measurement programme for 900-series at level +11m.

Figure 36: Example of cartography at level +11m (900-series)

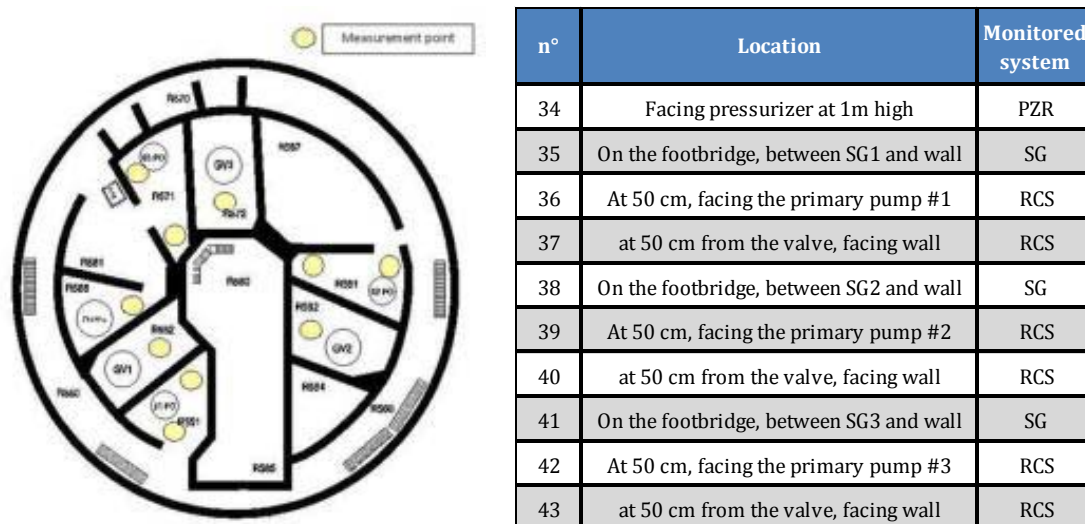

The implementation of this new index on every shutdown will allow the evolution of the dose rate in time monitoring and will allow detecting as quickly as possible any derivatives of pollution. In that case, corrective actions could be taken (on chemistry, on the hot spots, filtration or decontamination of system, etc.).

First years show that this index meets its initial objectives, allowing sites and corporate staffs:

- To compare quickly and easily the different units of a power plant in order to identify pollution levels.
- An analysis in time and through the operation cycles of the evolution of the radiological state of all the nuclear power plant units.
- The implementation of corrective actions.

Contamination characterisation

In addition to dose rates measurements, contamination characterisation is also achieved by gamma spectrometry (EMECC campaigns and CZT programme).

EMECC campaigns, germanium detector

EMECC campaigns (performed by CEA), given in Figure 37 have been commissioned for more than 30 years on French fleet units in order to better characterise contamination mechanisms. At the same time, EDF has also commissioned and financed EMECC campaigns on foreign units (Doel, Sizewell, Trillo during the 4 last years) with the contribution of several European operators in order to compare different good international practices.

Figure 37: EMECC Device



The EMECC programme has to be defined before the beginning of each campaign according to its specific aim. As an example, a typical EMECC programme performed in 2009 in a 4-loop unit is presented in Table 14 and Figure 38.

Table 14: Example of an EMECC programme performed in 2009 on a EDF 4-loop unit

Measurement points	Before oxygenation	After oxygenation
RCS – Hot leg – Loop 1	1	2
RCS – Hot leg – Loop 2	3	4
RCS – Crossover leg – Loop 1	5	
RCS – Crossover leg – Loop 2	6	
RCS – Cold leg – Loop 1	7	8
RCS – Cold leg – Loop 2	9	10
RCS – SG hot side – Loop 1	11	12
RCS – GG cold side – Loop 1	13	14
RCS – SG hot side – Loop 2	15	16
RCS – SG cold side – Loop 2	17	18
RCS – Bypass line – Loop 1	19	20
CVCS – NRHE	21	

Figure 38: Measurement point localisation during shutdown

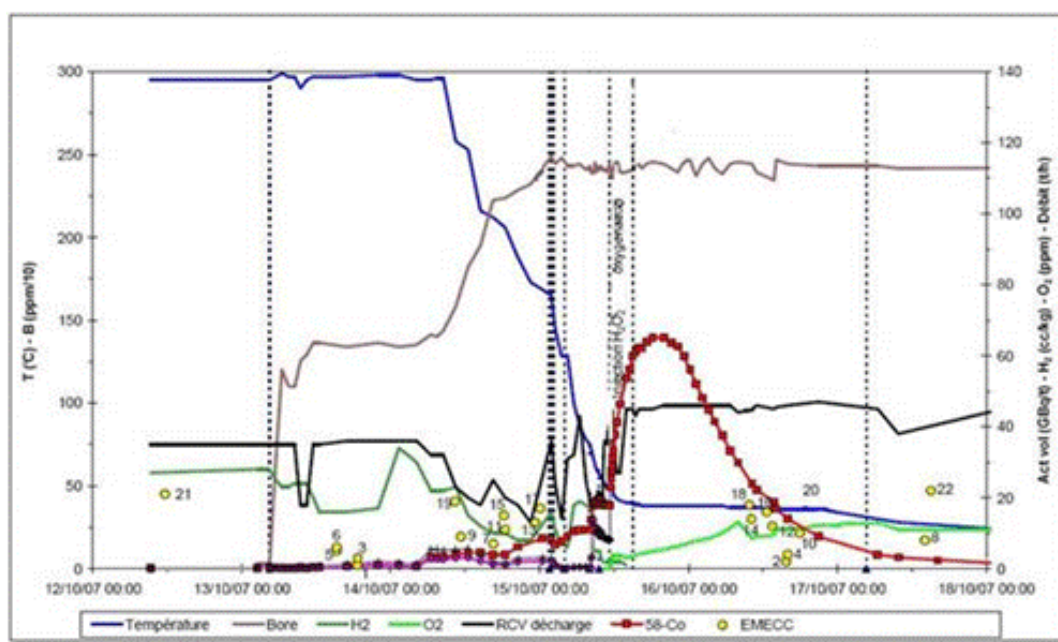

As an illustration, the evolution over cycles of ^{60}Co surface activity deposited on hot legs and steam generator tubes is shown respectively on Figure 39a and 39b for one unit representative of each EDF fleet sub-series.

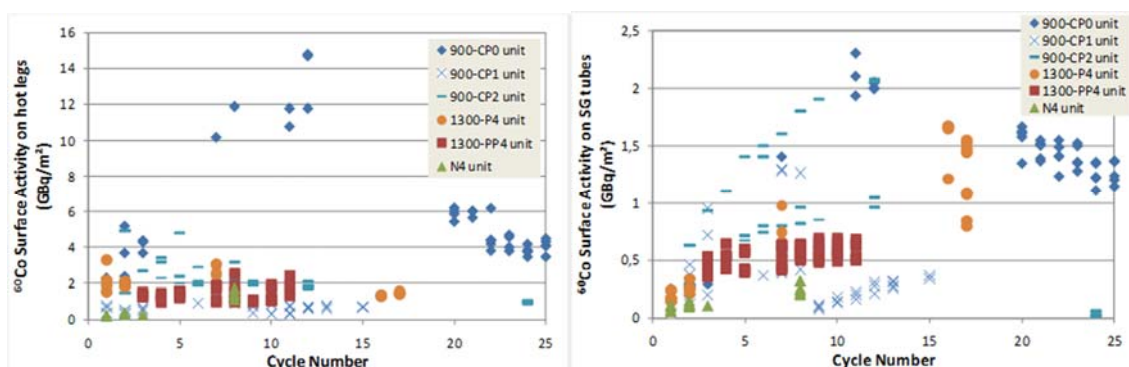
Figure 39: Evolution of ^{60}Co deposited activities on hot legs (39a) and steam generator tubes (39b)

CZT detector

As a matter of fact, EMECC campaigns are a very accurate way to characterise contamination in primary circuit but it clearly appears that the campaign number per year cannot exceed 10. There are 2 reasons explaining this limitation: in one hand, the CEA staff restricted capacity and in the other hand, a significant cost of each EMECC campaign.

Therefore, it is not possible to perform an EMECC campaign for every unit and every outage and this kind of characterisation is necessarily dedicated to specific major issues for EDF (impact on contamination of SG replacement, primary pump stopping criteria, pre-oxidation and acid-reducing cleaning after SG replacement or new plant first start-up) and particularly those with undertaking toward Authorities (zinc injection, fuel management impact for instance).

In order to give a supplementary operational way to each Radiation Protection Departments in each unit, EDF have been carrying out a new dose rate measurement programme since 2006 based on a semi-conductor CZT probe (Cadmium-Zinc-Tellurium).

General objectives of the CZT gamma spectrometer consists in allowing each nuclear plant:

- to characterise the radionuclide contribution to the dose equivalent rates in order to take the relevant action with regard to reducing staff exposure doses (radiation protection);
- to produce a “point zero” contamination diagnosis (source term);
- to monitor the evolution of contamination from one cycle to the next;
- to identify as soon as possible any penalising pollutants with regard to over-contamination risks;
- to assess the cleansing remedies efficiency.

Furthermore, the CZT “routine” programme has been optimised recently in order to give an efficient basis for the contamination mechanism understanding. This programme, containing 16 measurement points located on RCS, CVCS, SIS and RHRS (Table 15), was proposed to all units in 2010.

Table 15: CZT optimised programme

P1a P1b	CVCS	Before purification system	Power operation After fuel download
P2a P2b	CVCS	After purification system	Power operation After fuel download
P3a P3b	CVCS	Exchanger	Power operation After fuel download
P4a P4b	RCS	Crossover leg	Hot shutdown Pool flooding beginning
P5a P5b	RCS	Hot leg	Hot shutdown Pool flooding beginning
P6a P6b	RCS	Cold leg	Hot shutdown Pool flooding beginning
P7a P7b	SIS	Valve	Hot shutdown Pool flooding beginning
P8a P8b	RHRS	Exchanger	Hot shutdown Pool flooding beginning

5.1.2 EPRI methodology

The Standard Radiation Monitoring Programme (SRMP), sponsored by EPRI, was first instituted in 1978, as part of a more general programme with the major emphasis on improving plant reliability and availability. The objectives of this programme in 1978 were as follows:

- To provide a meaningful, consistent, and systematic approach to monitoring the rate of PWR radiation field build-up and to provide the basis for projecting the trend of those fields.
- To provide a reliable set of radiation field data for each participating plant, from which comparisons can be made.

- To monitor certain plant parameters that affect or may affect observed radiation fields.
- To use the information from this programme to identify plant design features, material selection, and operational techniques that present opportunities for radiation control.

The objectives of the SRMP have not changed. From 1983 to 1996, EPRI published reports as a result of the SRMP programme listing the factors that affect plant dose rates and quantitatively evaluated the effect of these factors. The most important factors at that time were found to be operational coolant chemistry and variations in cobalt input based on Inconel fuel grids.

The SRMP programme had consistent data collection efforts for Westinghouse and Combustion Engineering plants through 1985 and 1996, respectively. Afterwards, SRMP data collection had been limited primarily to plants that had implemented elevated primary coolant pH, zinc injection or replaced steam generators with Alloy 690 tubing.

In 2005, adverse industry trends in Radiation Protection were a key factor in the development of the NEI/EPRI/INPO RP 2020 Initiative that had the stated goal of ‘Taking Radiation off the Table.’ EPRI was charged with taking the technical lead for Radiation Source Term Reduction. In response to this initiative, the EPRI Chemistry and LLW Technical Advisory Committee strongly recommended that EPRI restart PWR radiation field data collection efforts to help quantify the effects of plant changes such as replacement steam generators, core uprating, adverse radiological incidents, and various changes in shutdown and normal chemistry procedures. These changes have caused unpredictable fluctuations in dose rates throughout the out-of-core surfaces, and a more fundamental understanding is required.

In 2007, the programme was reinstated and currently 129 units have submitted data to the programme. Several projects beginning in 2007 have used the collected data to evaluate a consider the effect of parameters such as plant age, chemistry control methodology, effective full power year (EFPY), coolant chemistry, cobalt source terms, and start-ups and shutdowns. These factors have been evaluated and published in other EPRI reports.

The collection of isotopic gamma spectroscopic data at the SRMP points was not part of the original programme even though some data exist from these plant locations. Defined procedures for the collection of this data will be developed in a 2012 EPRI project. The project will also define additional data collection points outside of the reactor coolant recirculation system.

Procedures

The SRMP survey procedures define the methodology needed to collect radiation surveys at well-defined locations and to record pertinent plant conditions. The data gathered in the surveys give a better understanding of the parameters that influence RCS radiation fields. This information will, in turn, provide the potential for reducing plant radiation fields.

Survey Point Priority

Several concerns about worker safety and ALARA were considered in the development of the programme and lead to the prioritization of the survey points. The survey locations were defined as “Required Points,” “Highly Recommended Points,” “Recommended Points,” and ‘Optional Information.’ The definitions of these terms are below:

- Required points are those that must be taken.

- Highly recommended are those that are strongly requested, but may be skipped in only cases of personnel safety, poor accessibility, or significant ALARA impact. The points have significant research value and the plants are asked to make the best possible effort to obtain them.
- Recommended points are those that are requested, but may be skipped in cases of personnel safety, poor accessibility, or significant ALARA impact.
- Optional information is information that is requested if available.

The procedures provide a controlled measurement programme for assessing radiation field trends of RCS components.

The radiation surveys are conducted during plant shutdowns and collect dose rate readings at permanent markers located on the outside surfaces of RCS components. Surveys are also specified for the internal surfaces of the steam generator channel heads when maintenance or inspection activities are performed.

Survey Points

The following section discusses the survey points and requirements of the radiation survey procedures for Westinghouse designed plants. Equivalent points have been identified in Combustion Engineering and Babcock and Wilcox designed PWRs [37].

Reactor Coolant Loop Piping Survey Procedure

The reactor coolant loop piping survey locations for a Westinghouse designed PWR are given in and are summarised in Figure 40.

Figure 40: Typical Westinghouse 4-Loop Plant With Piping and Steam Generator Survey Points Marked.

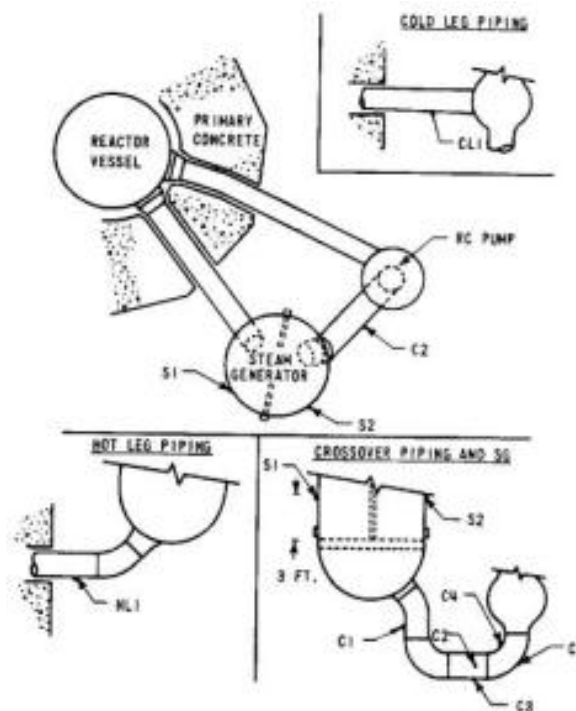

Required Points

- C2 – Straight section of crossover piping, side of pipe (generally away from primary concrete shield).
- HL1 – Bottom of hot leg piping between steam generator inlet and reactor vessel shield.
- CL1 – Bottom of cold leg piping between reactor coolant pump and reactor vessel shield.
- S1 & S2 if taken previously (See below).

Recommended Points

- C1 – Above crossover piping elbow, midway along vertical section of piping from the steam generator.
- C3 – Straight section of crossover piping, bottom.
- C4 – Crossover piping elbow to RCP, midway along inside radius.
- C5 – Crossover piping elbow to RCP, midway along outside radius.
- S1 – Outside of steam generator hot leg side, approximately 1 meter above top of channel head tube sheet and approximately midway between secondary side hand-hole cover and hot leg piping (90 degrees radially from the tube lane).
- S2 – Same as S1 but approximately midway between secondary side hand-hole cover and cold leg piping (90 degrees radially from the tube lane).

Optional Information Points

Note: Specify location of measurements, e.g., on letdown piping, one foot downstream of regenerative heat exchanger.

- Letdown piping.
- CVCS heat exchanger (on the shell).
- RHR piping.
- RHR heat exchangers (on the shell).
- Refueling water surface.

Steam Generator Channel Head Survey Procedure

If access to the steam generator channel head(s) occurs during the shutdown period, the results of the channel head survey are to be recorded on an appropriate survey form included in procedure. The Westinghouse designed steam generator channel head survey locations are summarised in Figure 41.

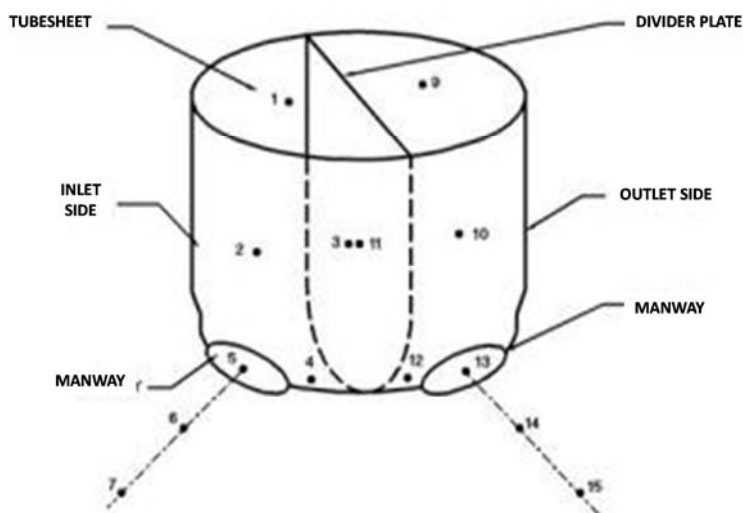
Figure 41: Westinghouse Plant Channel Head Survey Points

Required Points

- Midpoint of Tubesheet (Hot Leg & Cold Leg, points 1 and 9).
- Channel Head Center (Hot Leg & Cold Leg, points 2 and 10).
- Center Divider Plate (Hot Leg & Cold Leg, points 3 and 11).
- Bottom of Channel Head (Hot Leg & Cold Leg, points 4 and 12).

Recommended Points

- Manway Entrance (Hot Leg & Cold Leg, points 5 and 13).
- 30 centimeter from Manway (Hot Leg & Cold Leg, points 6 and 14).
- One meter from Manway (Hot Leg & Cold Leg, points 7 and 15).

5.1.3 Hot Spots

In most cases, hot spots are due to particles of cobalt activated by a neutron flux (^{60}Co) mainly from hard facing surfaces equipments (Stellite™, rich in cobalt) in the RCS (valves, pumps, internals, etc.). The contribution of hot spots to shutdown dosimetry may appear to be marginal in French PWR reactors (2 to 4%), but becomes more significant (15 to 25%) for the units affected. This excess dose has to be taken into account, particularly for the most exposed workers. Approximately ten French PWR units have been affected by this phenomenon over the last 15 years.

Surveillance is designed to inform the site as early as possible, of the presence of hot spots (mapping) in order to take the appropriate measures to prevent their propagation and/or to eradicate them. During unit operation, most hot spots will remain fixed to the fuel. Others may fall, by gravity, to the bottom of the pool or the low points of the primary coolant system or be trapped in the special devices. The most common locations are as follows:

- Thermal sleeves of the pressuriser.
- Steam generator packing glands.
- Valves of the primary cooling system, etc.

After the Residual Heat Removal System (RHRS) is placed in service, some hot spots may migrate into this circuit and be deposited or fixed. The most common locations are: the pumps, heat exchangers and valves of the circuit. An underwater pool cleaner should pass through the pool out after discharging. In this case, particularly high equivalent dose rates, equal to or greater than 1 Sv per hour, measured in contact with the filters, represent the last indicator of the possible presence of hot spots, before draining of the pools. Since no warning signs have been identified yet, to indicate the occurrence of hot spots, it was decided to concentrate on preventive filtering, trapping hot spots as close as possible to their source to eliminate them.

5.2 Water-Water Energetic Reactors (VVERs)

5.2.1 Dose rate measurements

An IAEA Regional Technical Co-operation Project RER/9/63 on Improving Occupational Radiation Protection in Nuclear Power Plants in Central and Eastern Europe and in Republics of the former Soviet Union was launched in 1997, having as one of its principal objectives to facilitate information exchange between Health Physics in VVER and RBMK nuclear power plants. In this forum a Working Group on Standardisation of Dose Rate Measurements in VVER reactors presented its first report in November 1998, when an agreement on a scheme for measurements was also reached. Pre-defined measuring positions, as shown on Figure 42, were used to measure dose rates in uncolimated arrangement 24–48 hours after reactor shutdown. It must be noted that as this measurement is performed shortly after shutdown, activity of short lived radionuclides like ^{51}Cr has higher impact to the result than some other longer lived radionuclides that have higher impact to dose rates later during outage. In November 1999, information from all VVER reactors was collected and presented for the first time by the members of the Working Group, and especially those who registered very low dose rates, to go back and investigate what may have had a significant impact on the dose rate. Comparison of VVER plant data for years 2000, 2001s is presented at Figure 43.

Figure 42: Measuring points of dose rates at VVER-440 reactors

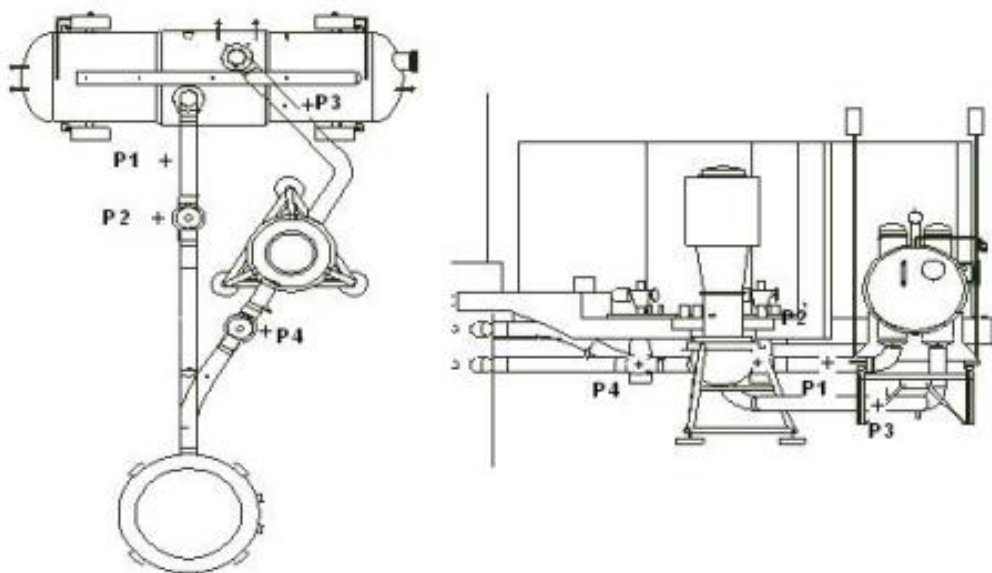
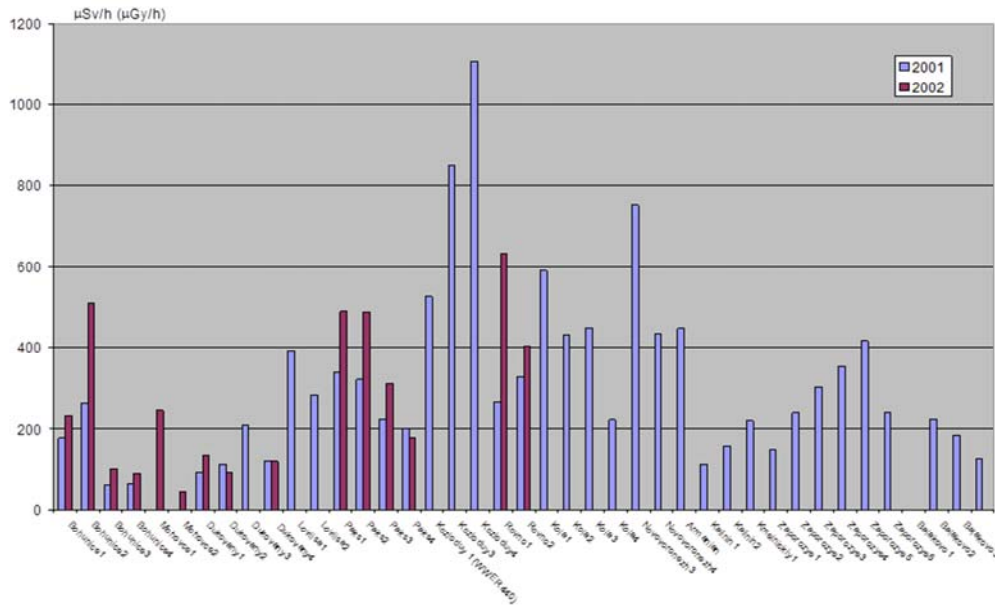

Figure 43: Comparison of primary loop dose rate averages for VVER reactors



Despite of fact that IAEA project was terminated in 2002, some plants still continue in these measurements, but data collection/comparison on the international basis does not continue. Results of these measurements for NPP Bohunice Unit EBO-3 over last 12 years is shown at Figures 44 and Figure 45 and for Paks-1 unit on Figure 46.

Figure 44: NPP Bohunice primary loop dose rates in period 2000–2012 by loops

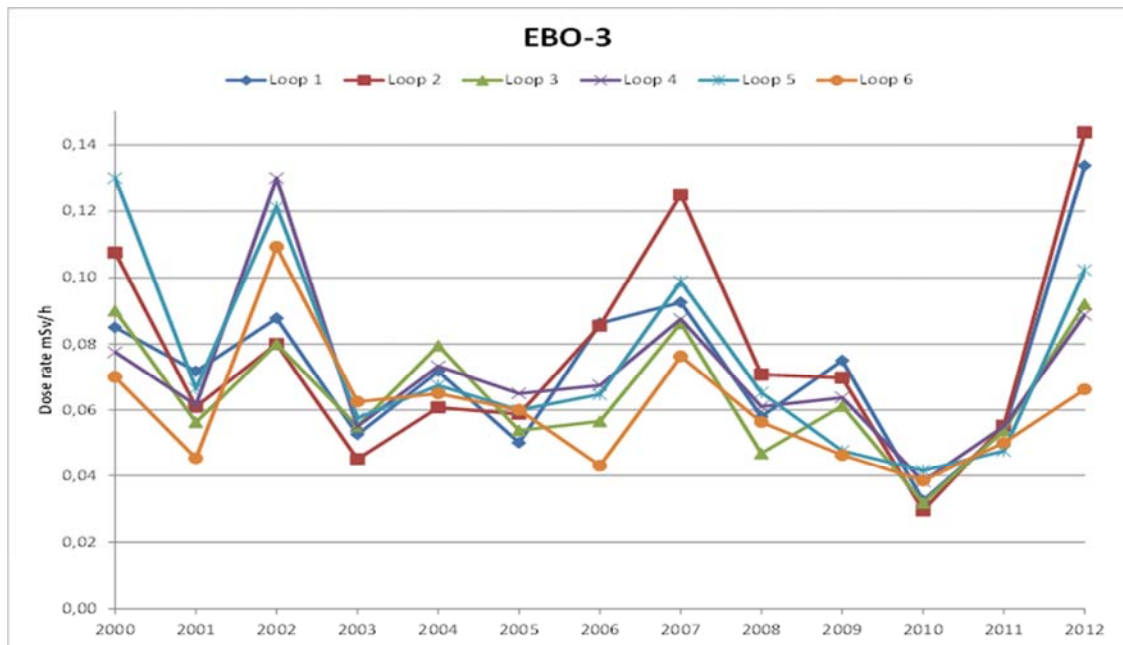

Figure 45: NPP Bohunice primary loop dose rates in period 2000–2012 by measurement points

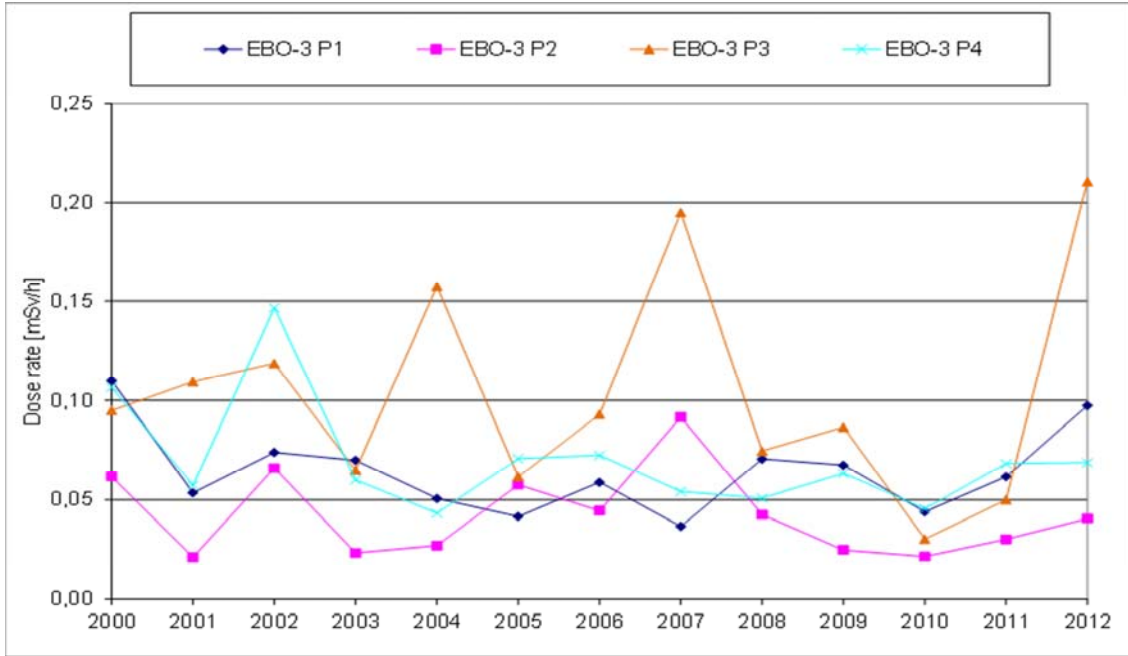
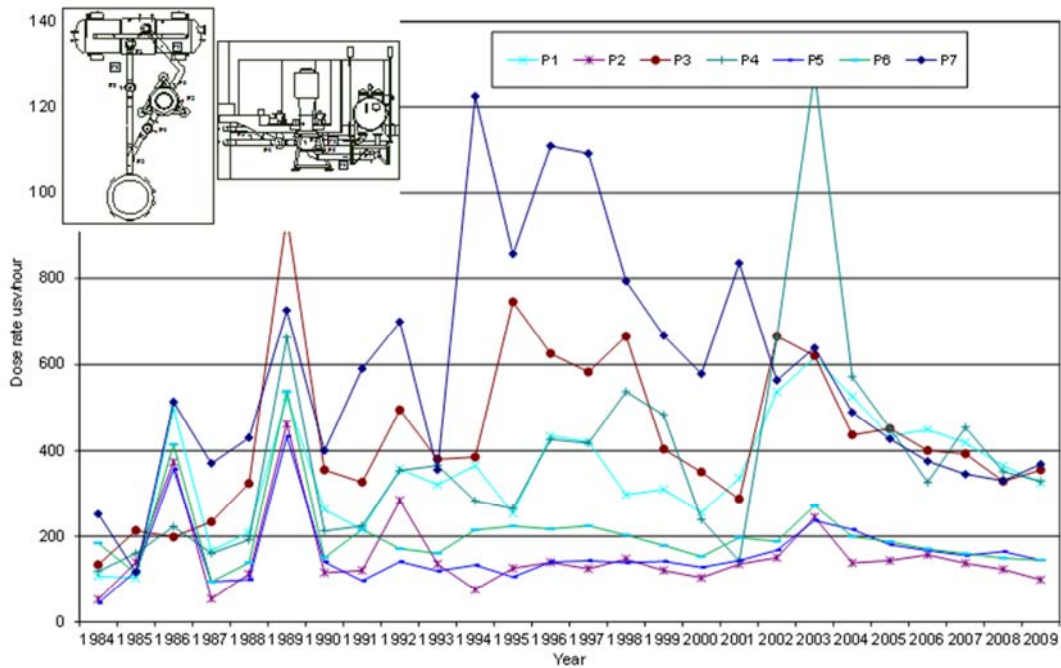

Figure 46: NPP Paks Unit 1 primary loop dose rates in period 1984–2009 by measurement points



5.2.2 In situ gamma spectrometry

This measurement technique for primary loop surface activities was first developed at the NPP Loviisa and NPP Paks [38] and later it was implemented also at other VVER NPPs – in Slovak and Czech Republic. At the beginning measurements were carried out at hot and cold leg of primary loops and later this technique was used at NPP Loviisa, Paks, Dukovany, Bohunice and Temelin also for monitoring of steam generators from outside [39], activity profile of vessels with ion exchange resins, titanium sponge in high temperature filters in order to optimise resin replacement/regenerations. Some plants are performing this measurement with their own staff and equipment but there are also specialised companies capable to provide this service for majority of plants.

Measurement is made by portable LN₂ cooled HPGE detector with collimator installed at reference points. Typically two measurements are made – one with plugged collimator hole and one with open hole to compensate environmental radiation in the vicinity of measurement locations. Efficiency calibration is made either by calculation (e.g. Monte Carlo modelling, Canberra ISOCS model) or by direct calibration using large surface type calibration source.

Measurement points are not well standardised among VVER plants, many plants measure at straight part of hot and cold leg and also at crossover leg of all primary loops as shown at Figure 46, NPP Loviisa performs measurement at 8 positions of one loop and 4 position of 2 additional loops (at this plant due to the space problem in the Steam Generator Compartment a full scan of all loops is almost impossible).

Figure 47: Measurement points scheme at Czech and Slovak NPPs Bohunice and Mochovce, Dukovany

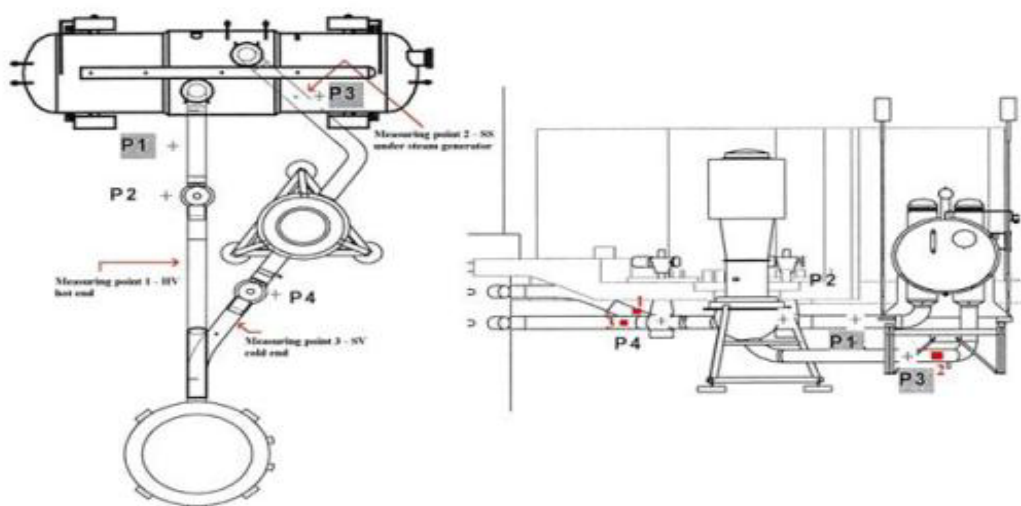

Examples of measurement arrangements are shown at following figures:

Figure 48: Primary loop piping mock up made purposely for NDT calibration/validation which was used for real efficiency calibration at Slovak NPP Bohunice.



Figure 49: Real measurement arrangement at Czech NPP Dukovany



Figure 50: Steam generator measurement at Hungarian NPP Paks



Figure 51: Activity profile measurement of primary clean-up filter at Czech NPP Temelin



Examples of surface activity trends

Comparison of measurement results over past 10-20 years for NPP Bohunice, Loviisa and Paks are shown at Figures 52-54. From these results it can be shown that in some cases variation of particular isotope activity are high – as it is for Loviisa and Paks, while in other case activity of is relatively stabilised – as for the NPP Bohunice unit EBO-3 case. Comparison with dose rate measurements for EBO-3 shows some correlation of dose rate measurement and loop surface activities data.

Figure 52: Average contamination levels on the 1st loop of Loviisa 1 (8 points) – values in kBq/cm².

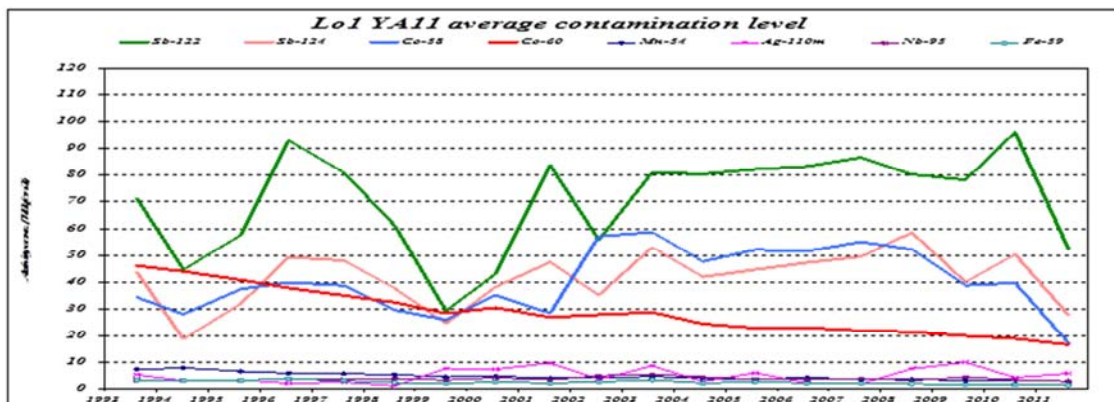

Figure 53: Average primary loop contamination levels on the PAKS-1 unit – values in kBq/cm².

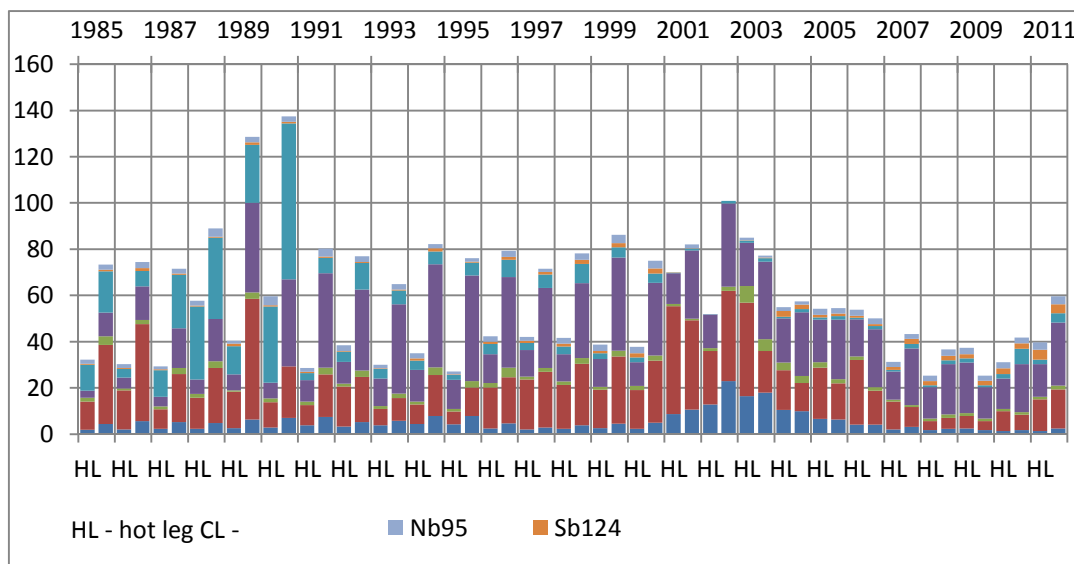
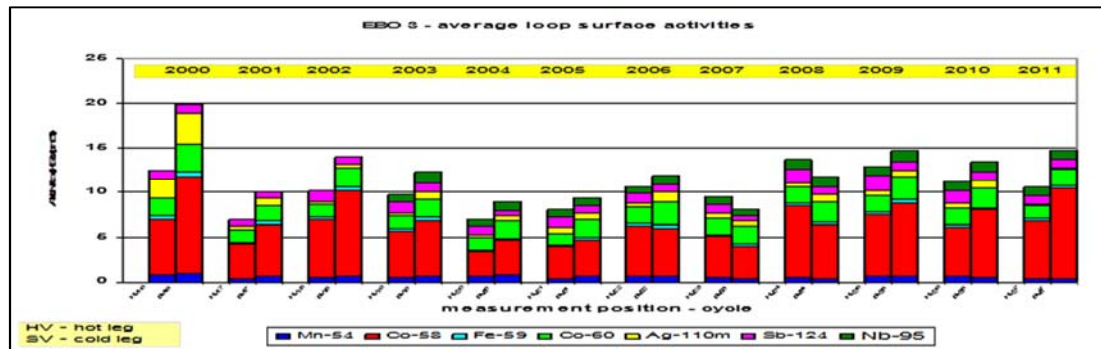

Figure 54: Average primary loop contamination levels on the Bohunice-3 unit – values in kBq/cm².



5.3 Boiling Water Reactors (BWR)

5.3.1 EPRI Methodology

EPRI BWR Radiation Level Assessment and Control Programme

The BWR fixed point radiation field survey programme, commonly referred to as BRAC (BWR Radiation Level Assessment and Control), is discussed in General Electric document NEDC-12688, which was issued in 1977 based on work sponsored jointly by General Electric and EPRI [34]. The intent of the BRAC programme is to establish a consistent set of fixed survey points in order to monitor radiation build-up, review plant operational and design factors for effect on dose rates, and to provide reference data input to radiation build-up modeling. The BRAC programme specifies locations, frequency, timing, and instrumentation for periodic fixed-point radiation dose rate surveys of BWR primary system components in order to provide consistent and comparable data.

Plants participating in the EPRI BWR Radiation Level Assessment and Control (BRAC) programme have classically used the Eberline HP220 A (E-530N) detector/shield housing assembly; however, other instruments that have been similarly calibrated may be applied. The HP220A detector consists of a small Geiger-Mueller detector inside a hemispherical tungsten shield, which provides a 7 to 1 attenuation front to back for ⁶⁰Co gamma emitters. A digital readout ratemeter is preferred, but analogue models are acceptable. Instruments that switch to a second, internal detector when on the highest scale should not be used for directional measurements. The collection of isotopic gamma spectroscopic data at the BRAC points has been routinely collected using plant and task specific procedures. Defined procedures for the collection of this data will be developed in a 2012 EPRI project.

Survey Points

Survey points are specified throughout the primary system, and include the suction and discharge piping of the recirculation pumps, suction and discharge piping of the reactor water clean-up pumps, the main steam lines, the inlet and outlet of the regenerative and non-regenerative heat exchangers, and points on the heat exchangers themselves. Figure 54 shows the BRAC sample points on the recirculation system of a typical BWR plant. The BRAC average values used throughout the summary reports for a set of measurements from a given plant, the average of the recirculation suction and discharge contact dose rate readings.

Figure 55: BWR radiation sampling points for typical BWR recirculation piping

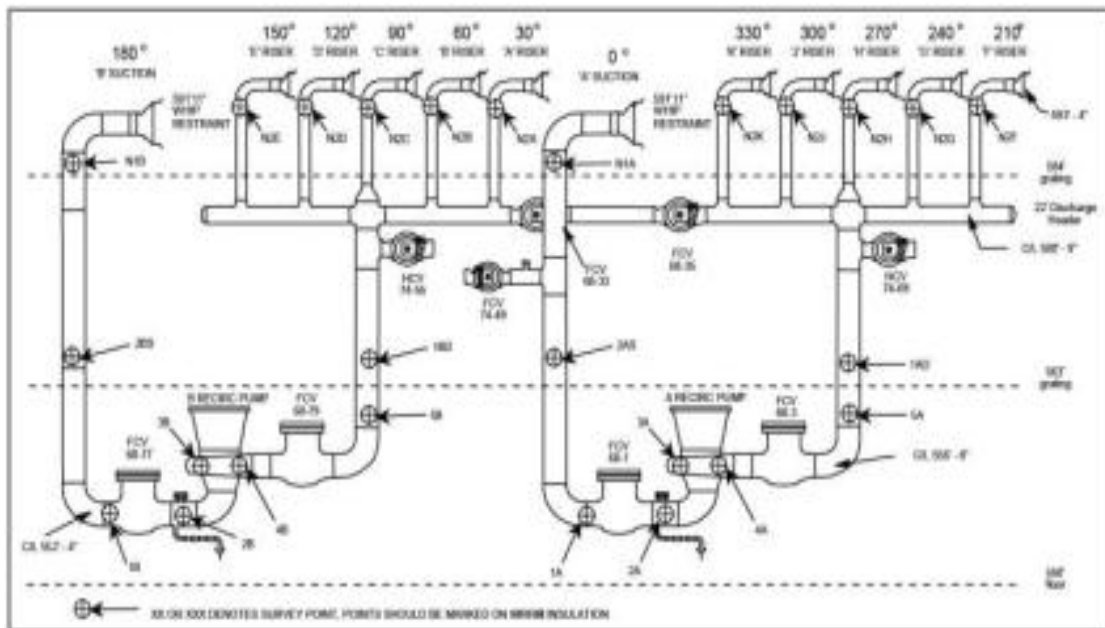

Surveys should be conducted with the component in its normal configuration; for example, with any insulation in place and liquid-filled. The BRAC programme does not specify a distance between the target survey point and the system components (e.g., a valve in the pipe) nor does it recommend a length for straight run of pipe. It only specifies that each unit should be consistent with its selected point. Differences in plant design, access platforms, etc. also contribute to inconsistency in the exact location of the survey points, but these are unavoidable.

Survey Timing and Plant Configuration

Surveys should be conducted during each refuelling outage and during other outages that are long enough to permit a meaningful survey. The surveys should be conducted between 7 and 14 days after shutdown, with the 7-day minimum to allow short lived isotopes to decay. Variability in the time at which surveys are taken may complicate the interpretation of the results; particularly in the absence of piping gamma scan results.

Surveys may be conducted when systems are drained or with insulation removed. Many units have changed insulation types over the years, which would change the effective standoff distance or the radiation shielding value of the insulation. Several plants have added permanent shielding to the BRAC components. Performing the survey with systems drained will most likely result in higher readings than if the system was full.

Time after shutdown when the survey is taken can also vary significantly. Plants obtain BRAC surveys for trending, even in short mid-cycle outages. The continued compression of outages may make collecting consistent BRAC data in the specified 7 to 14 days range more difficult. Shielding may be installed on components well before the 7-day minimum. Plants then must either take the BRAC survey early or wait past the 14-day recommendation, when the system is restored. In addition, if a plant experiences a fuel failure during the cycle, 7 to 14 days may actually be insufficient to eliminate the unique contribution from the additional iodine-131.

5.3.2 ASEA Atom methodology at Vattenfall

In the late seventies ASEA Atom developed a methodology for the fleet of plants that was built by the company – in total nine stations at the Oskarshamn, Ringhals, Forsmark and Olkiluoto sites in Sweden and Finland. The methodology was named MADAC (Mobile Analyser for the Detection of Activity in Crud) and is based on collimated measurements with a shielded germanium detector (Figure 55).

The MADAC programme has been further adapted at the Ringhals site to also become applicable on the Westinghouse PWR units at the site (Ringhals 2, 3 and 4). With time the name of the methodology has changed, and the MADAC designation is no longer used. Current names in use are NYMF at Forsmark, SAM at Ringhals, NSSAM at Oskarshamn.

A portable low efficiency HPGe detector (ca 4 %) is placed on a cart with shielding, as shown in Figure 40. Another cart is equipped with a digital MCA and laptop. Data are collected to the laptop and copied to an office computer to correct for background, efficiency and decay since the beginning of the outage.

Typical measurement points during a campaign are [40, 41]:

- On each of the two pipes that lead water from the reactor tank to the shutdown cooling system. This system also feeds water to the reactor water clean-up system (RWCU).
- On the pipes and selected heat exchangers along the RWCU system: before heat removal, after heat removal but before filtration, after filtration and after final regenerative heat exchange. The temperature dependence of the surface contamination can be observed.
- On a pipe for the system that supplies water to the hydraulic scram function and to the crud removal flow through the control rod guide tubes. This water is a partial flow of the filtrated water from the RWCU system.
- On a pipe of the cooling and clean-up system for the fuel pool water.
- On two of the steam lines close to the high pressure turbines.

The outcome of the measurements is the radionuclide specific contamination inside pipes and heat exchangers, given in Bq/m². In order to obtain a correct value, great care has to be taken as the efficiency of the measurement is calculated. The efficiency calibration is based on the reference measurement of a certified planar source of ¹⁵²Eu. A correction is then done for the actual conditions at the measurement point, taking into consideration the materials and dimensions of the pipes or heat exchangers, whether the system is water filled, the amount of insulation present and the size of the collimator.

At the Swedish Vattenfall sites (Forsmark and Ringhals), as well as the E.ON site (Oskarshamn) there is a measurement campaign for each station during the annual outage. The results and conclusions are reviewed and spread within the organisation. Typical applications are:

- Assessment of which radionuclides that contribute to the total dose rate. The dose rate is mostly dominated by ⁶⁰Co with occasional large contributions by mainly ^{110m}Ag, ⁵⁸Co or ¹²⁴Sb.
- Trend analysis and assessment of the causes for trend development.
- Assessment of radioactive inventory in waste, either directly or the results may be used as data input for radionuclide vectors.

An obvious strong point of the measurement of surface contamination is that the result will be consistent even as insulation is removed or the system is drained. The result is also not affected by for example the thickness of a pipe. This is not the case for dose rate measurements where the result will be higher for a drained or de-insulated component, or for a thinner pipe. As results are compared between measurement points or plants, consideration must be given to what is to be compared: to compare surface contamination will yield information about the nature of the source term while the comparison of any dose based measurement will yield information about the effect of the source term.

Figure 56: Portable HPGe detector with collimated shielding for a BWR MADAC based measurement campaign, here measuring on a BWR-75 steam pipe (Forsmark 3)



6. Conclusions

Radiation fields are developed over time from the deposition of activated corrosion products. In most cases, these fields are dominated by the deposition of ^{58}Co and ^{60}Co on out-of-core piping areas. There are cases of other radionuclides impacting radiation fields including, but not limited to, antimony and silver isotopes. It is estimated that Cycle ^{58}Co (s) surface activities can be impacted more over the last 3 – 6 months of operation, while the surface activity of ^{60}Co is developed over several years. Changes to one or more of the many factors related to activity release and uptake will impact these fields.

Plant chemists continue to optimise and review new technologies and strategies to minimise corrosion and release, thereby minimising the inventory available for activation. These strategies include operational, shutdown, and start up chemistry controls, optimisation of clean-up systems and coordination of specifications, work activities and challenges faced with major component replacements.

There are many monitoring strategies implemented throughout the fleet and, in many cases, is specific to the localisation, utility and NSSS designs. The application of gamma scanning (CZT, HP germanium or others) technologies provide key insight into

oxide changes when implementing new or optimising technologies. By observing these changes, chemists can optimise and apply different technologies based on these changes and an understanding of the NSSS site specific design. The strategies may include optimisation of pH and shutdown strategies, online noble chemical injection, and zinc injection.

The application of long term systematic dose rate monitoring provides the utility with an overall trend related to materials, chemistry, and core design, but has a limited short-term impact when evaluating new technologies to oxide changes or other factors impacting dose rate.

The Radiation Protection Manager (RPM) is faced with many obstacles in dose reduction efforts. This requires a strong coordination between Chemistry, Operations, and Engineering. It is critical for the RPM to maintain a balance between source term (dose rate issues) and dose (work practices, planning, etc.). These two terms are often interchanged with the same thought process, but requires a different approach and resolution for each area.

The application of technically and scientific based chemistry controls, optimised clean-up controls and operations, selection of optimised low cobalt materials, and operational execution allows the organisation to work together reducing source term. Working together with a strong source term reduction programme and optimised worker practices allows the utility to address long term dose goals.

Appendix 1

Typical primary materials for PWRs

Table 1: Weight Percent Composition of Structural Alloys

Element	Steam Generator Tubing			Structural		Zircaloy-4 (ASTM R60804)	Cladding	
	Alloy 600	Alloy 690	Alloy 800	304 SS	316 SS		Standard ZIRLO™	M5™
C	0.01– 0.05	0.015– 0.025	<0.03	≤0.08	≤0.08			
Co	0.015– 0.10	0.015– 0.10 (≤0.015 for tubing)	<0.10			≤0.0020		
Cr	14.0– 17.0	28.0– 31.0	20-23	18-20	16-18	0.07-0.13		
Cu	<0.50	<0.50	<0.75			≤0.0050		
Fe	6.0–10.0	7.0–11.0	balance	balance	balance	0.18-0.24	0.09-0.13	~0.0350
Mn	<1.0	<0.50	0.4–1.0	≤2.00	≤2.00	≤0.0050		
Mo					2.0-3.0	≤0.0050		
Nb						≤0.0100	0.80-1.20	0.80-1.20
Ni	>72.0	>58.0	32.0–35.0	8-11	11-14	≤0.007		
O						0.09-0.160	0.10-0.15	0.110- 0.170
P				≤0.04	≤0.03			
S				≤0.03	≤0.03	≤0.0270		0.0010- 0.0035
Si				≤0.75	≤0.75	≤0.0120		
Sn						1.20-1.70	0.80-1.10	
Zr						balance	balance	balance

Table 2 from Reference [6] provides an example of hard faced cobalt materials composition while Table 3 provides examples related to hard faced nickel material composition.

Table 2: Weight Percent Composition of Cobalt-Based Hardfacing Alloys

Alloy	Weight %									
	Co	Cr	Ni	Fe	C	Mn	W	Si	B	Mo
Co-156	bal	29	3	0.75	1.6	1	4.5	1.2		1
Haynes 36	bal	18.5	10	2	0.4		15		0.03	
Stellite™ 6	bal	33	3	3	1.1		6			
Stellite™ 6B	bal	30	3	3	1.1	2	4.5	2		1.5
Stellite™ 21	bal	27	2.8		0.25					1

Table 3: Weight Percent Composition of Nickel-Based Hardfacing Alloys

Alloy	Weight %									
	Ni	Cr	Fe	C	W	Si	B	Mo	Other	
Colmonoy 4	bal	10	2.5	0.4		2.8	2.1			
Colmonoy 5	bal	13.8	4.8	0.45		3.3	2.1			
Deloro 50	bal	12	3	0.35		3.5	2.5			
Metco 19E	bal	16		0.5				2.4	Si+B+Fe=4	
Nucalloy 488	bal	17.5	5.5	0.3	1	6.8	1		Sn=0.7	
Trialoy T700	bal	15.5		0.08		3.4		32.5	Co+Fe=< 3	

Appendix 2

Strategy for Implementing an Optimised CZT programme

CZT shutdown carried out by EDF

The ambition of the EDF nuclear power plant fleet is to reduce the individual and collective doses of the PWR (Pressurised Water Reactor) units to the level of the best international operators.

I – Context

In 2003 a “source term reduction” action plan, developed within the scope of the ALARA Project, was validated by the (Nuclear Power Generation Division) of EDF. This action plan was aimed at reducing contamination of the circuits, both in normal condition and deriving from incidents. It integrated a priority class action which consisted in making a portable Cadmium-Zinc-Tellurium (CZT) gamma spectrometer available for the analysis of extra-flow deposits by the radiation protection department.

This industrial tool is a circuit contamination diagnostic support tool which serves as a complement to the activity concentration analysis device of the RCS (Reactor Cooling System) carried out by the chemists. In particular, it allows identifying pollution agents penalising with regard to doses, which are most often insoluble and, as a result, cannot be measured by the chemists in liquid samples.

As of 2006, a first programme of CZT measurements to be performed was made available to the radiation protection department, in order to harmonise the measurements to be performed at each unit shutdown.

In 2007, an analysis of the results of the CZT measurements obtained during shutdowns (2006–2007) was prepared. This document shows that, when properly used, the CZT technology is capable of adequately quantifying the contribution of the main radionuclides to the dose rate. For optimisation purposes, some modifications to the programme's measuring points were then proposed.

In 2008, a complementary programme for the units which are attached to the National cleaning programme was proposed. This programme included special measurements on the RHRS/CVCS (Residual Heat Removal System/Chemical and Volume Control System) circuit and on the BRS (Boron Recycle System) and LWTS (Liquid Waste Treatment System) tanks, which need to be cleaned. Feedback on the 5 units (Chinon 2, Flamanville 1, Gravelines 3, Bugey 2 and Blayais 4) which have been cleaned since 2004, has led to propose some more modifications in view of optimisation.

II – Main characteristics of the CZT spectrometer



The CZT gamma spectrometer developed by CEA & EDF, and commercialised by Canberra for use in nuclear plants, has five main components:

- a set of 3 CZT interchangeable probes (Ritec) of varying sensitivity;
- a cable between the probe and the electronic measurement chain part;
- the electronic measurement chain;
- a laptop PC;
- a probe collimator and its tripod support.

The advanced functions of this equipment give the user indispensable elements for real time spectrum analysis, in particular:

- real time acquisition, display and storage of the gamma spectrum;
- identification of the 10 main nuclear plant radionuclides: ^{58}Co , ^{60}Co , $^{110\text{m}}\text{Ag}$, ^{124}Sb , ^{122}Sb , ^{51}Cr , ^{59}Fe , ^{54}Mn , ^{131}I and ^{137}Cs ;
- calculation of the contribution of the radionuclides to the dose rate outside the circuits expressed as a % of Sv/h;
- calculation of the contribution of the radionuclides to the activity deposition inside the ex-core circuits surfaces expressed as a % of Bq.

The following diagram shows the measurement principle of the CZT gamma spectrometer for dose analysis giving 2 results: the dose-rate % (Sv/h) and/or the activity deposition % (Bq). The equipment is shipped with 3 interchangeable CZT probes of varying sensitivity:

- 60 mm³: 0.5 mGy/h – 10 mGy/h.
- 20 mm³: 5 mGy/h – 100 mGy/h.
- 5 mm³: 20 mGy/h – 150 mGy/h.

It identifies the gamma radionuclides in the energy range from 100 to 1.800 keV for exposures from 0.5 to 150 mGy/h. The spectral resolution is approximately 15 keV at 600 keV and 25 keV at 1.300 keV. Approximately 15 minutes is necessary for the acquisition of a spectrum with an exposure of 1 mGy/h, without a probe collimator.

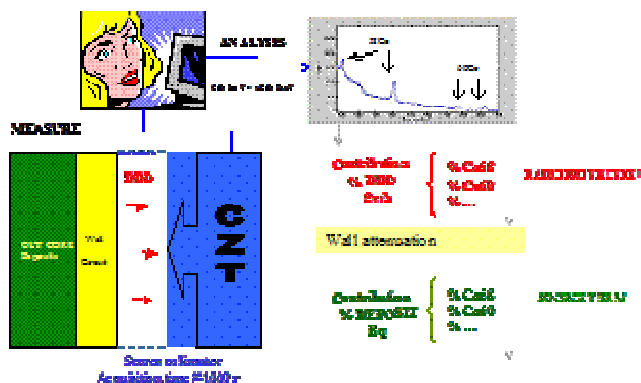

Given as examples, the following spectrums are obtained using a CZT probe for a Reactor Coolant (RCS) loop piping and for a heat exchanger for the chemical and volume control (CVCS) purification circuit polluted by silver.

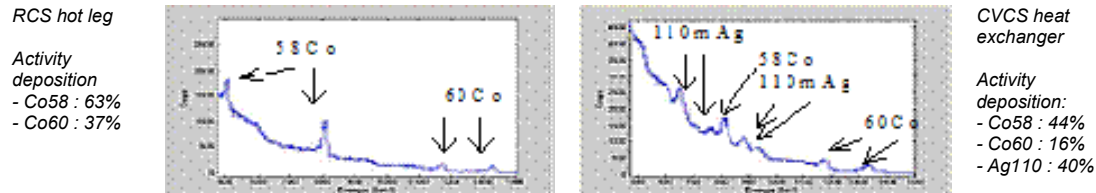

The spectrums measured by the power plants usually present important contributions in ^{58}Co , ^{60}Co and $^{110\text{m}}\text{Ag}$ with quite important pipe thicknesses. Thereafter analyses will then be based on dose rates contributions. This is entirely coherent with the interest and the possibility of the CZT which is aimed to be a radiation protection tool rather than a characterisation and fine metrology tool.

III – Objectives of the optimised programme for CZT gamma measurements

It was proposed that the optimised programme for measurements via CZT gamma spectrometry to be performed at each shutdown by the radiation protection department be implemented throughout the EDF NPP fleet from 2011.

The purpose of this optimised programme for CZT measurements is:

- to characterise the contribution of radioelements to the dose rates in order to implement appropriate measures to reduce staff exposure doses (radiological protection);
- to set a “point zero” contamination diagnosis (source term);
- to monitor the evolution of contamination from one cycle to the next;
- to identify, as early as possible, the penalising pollution agents with regard to the risk of over-contamination in order to adopt the proper behaviour depending on the pollution agents;
- to determine the decontamination solutions to be implemented on the circuits to be cleaned;
- to assess the efficiency of the decontamination solutions;
- to ensure that circuits are not re-contaminated following decontamination operations.

Optimised programme for CZT gamma measurements

The optimised programme for CZT gamma measurements was developed using the feedback from sites which had implemented the CZT measurement programme during unit shut down on the one hand and the CZT programme developed for cleaning purpose on the other hand.

CZT measurement programme applicable during unit shutdown

The first programme, which had been implemented since 2006, included 16 measuring points broken down into 2 series of 8 identical points:

- the first series was carried out at the beginning of shutdown, prior to oxygenation;

- the second one was carried out at the end, following oxygenation.

Reminder of the programme's 8 measuring points:

- P1: CVCS – Upstream from purification.
- P2: CVCS – Downstream from purification.
- P3: CVCS – Non regenerative heat exchanger: Body of the heat exchanger.
- P4: RCSFPCTS (Reactor Cavity and Spent Fuel Pit Cooling and Treatment System): RCSFPCTS Podium: Junction of the drainage lines.
- P5: RCS (Reactor Coolant System) – Hot leg.
- P6: RCS – Cold leg.
- P7: RCS/SIS (Safety Injection System) valve.
- P8: RHRS – Heat exchanger: Body of the heat exchanger.

The feedback from the NPPs shows that all the points are relevant except the Podium point (P4), where very variable dose rates were obtained from one unit to another, from 0.07 to 100 mSv/h, 94% of which was generated by the ⁶⁰Co on average. Therefore, it has been proposed that the P4 “RCSFPCTS Podium” point should no longer be used.

Moreover, a study showed that CZT measurements on the Hot and Cold legs (P5 and P6) on the one hand and on the RCS/SIS valve (P7) on the other hand were relevant to readjust the spectra, which are input data to create dose rate models in a multi-radioactive source premise (Panthère calculation).

Finally, the feedback network of the CZT users proposed adding an additional “Crossover leg” point which would provide the advantage of making the results obtained on the primary coolant loops reliable. This is also coherent with the DSRE index⁷ already prescribed.

Partial conclusion: The RCSFPCTS Podium point (P4), which is not significant, should be replaced by a “Crossover leg” measuring point. This would, in fact, allow additional elements to be obtained in order to readjust the spectra for the Panthère calculations; it would also make the programme homogeneous with the DSRE index, which is relevant due to its history.

CZT programme developed for the National cleaning purposes

With regard to the units attached to the National cleaning contract the programme included 5 additional measuring points in relation to the initial programme to be performed during shutdown. These 5 measuring points were:

- Point 01: RHRS circuit: body of the heat exchanger.
- Point 02: RHRS circuit: valve.
- Point 03: CVCS circuit: body of the heat exchanger.
- Point 04: CVCS circuit: discharge line.
- Point 05: NIVDS (Nuclear Island Vent and Drain System) circuit: bottom of NIVDS tank.

7. The DSRE index represents an average of the dose rate measurements taken in contact with the reactor coolant pipes (Hot leg, Cold Leg, Crossover Leg) between $t_0 + 12$ h and $t_0 + 16$ h, where t_0 represents the time the rods are dropped.

The feedback from the summaries performed on the cleaned units stressed that:

- Point 01 is equivalent to point P8 of the initial CZT measurement programme.
- Points 02 and 04 do not provide any additional information with regard to that which is obtained from the measurements of the initial CZT measurement programme.
- Point 03 may be replaced by point P1 of the initial CZT measurement programme workers performing the measurement receive less dose and it is as relevant to help select decontamination solutions to be implemented to drain the RHRS/CVCS circuit.
- Point 05 systematically produces the same results on all the units being monitored in the circuit.

Partial conclusion: The cleaning programme could be integrated in an optimised CZT measurement programme. This optimised programme would integrate both the needs of all the operating plants and those of the units attached to the national cleaning programme. This optimised CZT measurement programme would then exclude points 02, 04 and 05 from the cleaning programme. Point P1 of the initial CZT measurement programme to be performed during shutdown replaces point 03 of the cleaning programme. Point P8 is equivalent to point 01.

Global conclusion: Given the conclusions provided above, it is now necessary to give a detailed description of the optimised CZT measurement programme to be carried out during shutdown of the units by the radiological protection department as of 2011 on all the units of the EDF fleet. This optimised programme includes 16 CZT measuring points.

IV – Description of the optimised CZT measurement programme to be implemented at each shutdown

Given the modifications made to the initial shutdown and cleaning programmes, EDF shall select the optimised CZT gamma measurement programme to be performed systematically during each shutdown and which includes 16 measuring points with 2 series and 8 identical points: see table below.

Description and precise location of the measuring points in the NAB (Nuclear Auxiliary Building)	
<u>P1</u> : CVCS –	Upstream from purification: Between the regenerative heat exchanger and the non-regenerative heat exchanger. P1-a: Measurement to be performed in Operation the week before uncoupling. P1-b: Measurement to be performed in Refuelling mode when the pool is being filled.
<u>P2</u> : CVCS –	Downstream from purification: Downstream from the volumetric control CVCS tank, except for the premise where this tank is located. P2-a: Measurement to be performed in Operation the week before uncoupling. P2-b: Measurement to be performed in Refuelling mode when the pool is being filled.
<u>P3</u> : CVCS –	Non regenerative heat exchanger: Body of the heat exchanger. P3-a: Measurement to be performed in Operation the week before uncoupling. P3-b: Measurement to be performed in Refuelling mode when the pool is being filled.

Description and precise location of the measuring points in the RB (Reactor Building)	
P4: RCS –	Crossover Leg: Loop 1, same point as for the DSRE index. P4-a: Measurement to be performed in Hot standby conditions. P4-b: Measurement to be performed in Refuelling mode when the pool is being filled.
P5: RCS –	Hot Leg: Loop 1, same point as for the DSRE index. P5-a: Measurement to be performed in Hot standby conditions. P5-b: Measurement to be performed in Refuelling mode when the pool is being filled.
P6: RCS –	Cold Leg: Loop 1, same point as for the DSRE index. P6-a: Measurement to be performed in Hot standby conditions. P6-b: Measurement to be performed in Refuelling mode when the pool is being filled.
P7: RCS/SIS –	Valve: Injection check valve of the SIS accumulators, measurement on the RCS side. P7-a: Measurement to be performed in Hot standby conditions; P7-b: Measurement to be performed in Refuelling mode when the pool is being filled.
P8: RHRS –	Heat exchanger: Body of the heat exchanger: active channel(s). P8-a: Measurement to be performed in Hot standby conditions. P8-b: Measurement to be performed in Refuelling mode when the pool is being filled.

These measurements are to be performed by the radiation protection Department at each shutdown: Simple Shutdown for Reload, Partial Inspection or Ten-yearly inspection.

Note: As an example, the photographs of the points to be created for this optimised programme, the indications regarding the premises and the operating indicators of the NPP of Belleville (unit 1.300 MW, plant series P'4) are to be found at the end of this document.

V – Justification of the choice of the points of the optimised CZT programme to be carried out

P1& P2: CVCS “Upstream from Purification” & “Downstream from Purification”

These measuring points allow the deposits of the CVCS auxiliary upstream and downstream from the purification treatment on filters and CVCS resins to be characterised. These measurements are analysed so as to:

- assess the efficiency of the CVCS purification with operating unit and shutdown unit;
- optimise the chemistry of the shutdown in case of pollution (^{110m}Ag , ^{124}Sb , etc.)
- understand the evolutions of these parameters in order to prevent, if possible, the aggravation or the continuation of the pollution phenomenon.

Note: Point P1 is relevant for the implementation of adequate solutions to clean the CVCS/RHRS circuit.

P3: CVCS "Non regenerative heat exchanger"

This measuring point allows, in particular and if necessary, the ^{110m}Ag which has a strong propensity to form a deposit on the cold parts of the heat exchangers to be detected.

P4, P5 & P6: RCS “Crossover Leg”, “Hot Leg” & “Cold Leg”:

These measuring points allow:

- characterisation of the deposits in hot leg, cold leg and crossover leg of the CPP, which represent, excluding pollution, the normal contamination of the operating units;
- optimisation of the operating factors (pH, oxidant admission, etc.);
- optimisation of the cold shutdown procedure (cooling speed, oxygenation, shutdown criteria for the last primary coolant pump, etc.);
- identification, in certain cases, of over-contaminations involving the entire CPP (^{58}Co , ^{124}Sb , etc.).

Note: Most often, the contamination status of the Cold Leg is close to that of the SGs, which allows, as a first approximation, avoiding measurements on the SG to be carried out systematically (unfavourable operations regarding the dose).

P7: “RCS/SIS valve”

This measuring point allows:

- early detection of the “hot points” risk;
- completion of the characteristic points of the CPP legs (P4, P5, P6) to adjust the spectrum required to perform Panthère studies.

Note: Some particularities (low points, valves, steam generator packing ring, etc.) are also relevant “hot points” risk indicators for the circuits. Taken the “hot points” dosimetric considerations, for a significant content of ^{60}Co in the deposits, decisions should be taken in real-time.

P8: RHRS “Heat exchange”

The RHRS circuit is in operation only during shutdown. This measuring point allows:

- detection of possible recontamination during shutdowns;
- identification of possible $^{110\text{m}}\text{Ag}$ pollution (to complement P3);
- early detection of pollution by hot points in particular.

Note: This point is relevant for the implementation of adequate solutions to drain the CVCS/RHRS circuit.

VI – FENELON Jean François Accuracy of the results

A comparison of the results obtained with a CZT detector and an Ultra-pure Germanium detector leads to the following results:

- the CZT detector is capable of identifying the main radionuclides (part that is greater than 10% of the dose rate) coherently with the Germanium spectrometer;
- the uncertainty is higher for a CZT measurement than for Germanium measurement.

We will bear in mind, in particular, that when correctly used, and in a radiological protection logic, the CZT technology is capable of obtaining results which are totally satisfactory for the main radionuclides.

VII – On-site implementation of the optimised CZT programme

Impacts of the implementation of the optimised CZT measurements programme

Execution time of the measurements

The time required to perform a CZT measurement is 30 minutes:

- 15 minutes to install and uninstall the spectrometric probe on the components;
- 15 minutes of exposure of the probe to obtain a good quality spectrum.

Of these 16 measurements

- 6 are to be carried out in the NAB (Nuclear Auxiliary Building);
- 10 are to be carried out in the RB (Reactor Building).

Execution of the 6 CZT measurements in the NAB	
Modalities of execution	Cumulative duration of execution
3 in operation, in the week prior to decoupling	1h30 (3 x 0h30)
3 in refuelling mode when the pool is being filled	1h30 (3 x 0h30)

Execution of the 10 CZT measurements in the RB	
Modalities of execution	Cumulative duration of execution
5 in Hot standby conditions	2h30 (5 x 0h30)
5 in refuelling mode when the pool is being filled	2h30 (5 x 0h30)

The execution time of the programme is therefore 8 hours to perform the measurements, to which 4 hours should be added to interpret the spectra. Ultimately, the full execution and interpretation of the measurement programme take 12 hours per shutdown.

Compatibility of the optimised CZT programme with the shutdown schedule

A study performed by EDF reached the conclusion that it is possible to integrate these CZT measurements during shutdowns without any impact on the schedule. This study was carried out on the basis of a Shutdown schedule for a Simple Shutdown for Reload for a 900MW unit for a 19 day target, i.e. with the most restrictive durations.

Integrated doses

According to the feedback, the integrated collective dose for the entire optimised CZT measurement programme is estimated to be 0.5 H.mSv.

Restitution of the measurement

The “CZT-report” software developed by EDF and which is installed in the Inspecteur 1.000 CZT spectrometers:

- capitalises the results of the CZT measurements obtained during the execution of the systematic programme (round);
- produces a table of these results in standardised form in Excel format.

Training of the radiation protection Department personnel on CZT measurements

Upon delivery of the equipment to the site, the manufacturer will have provided training which includes a theoretical and a practical part.

Given the durability of the CZT measurements to be performed on the fleet, EDF sets up training for every shutdown to meet the requirements of the radiation protection personnel who use the CZT spectrometers. The fundamental teaching objectives are the following:

- analyse a spectrum produced by the CZT;
- interpret the results of this spectrum;
- use these results to propose solutions to improve radiological conditions;
- implement the CZT to obtain a relevant measurement;
- run the software.

VIII – Complementarity of the optimised CZT gamma measurement programme and the RB index

The result of the optimised CZT measurement programme shall be complementary to:

- the RB index and the sub-indices per circuit: IRHRS, ICVCS, IRCS, ISIS, etc.;
- The DSRE index.

In particular, there are complementarities between:

- the P1, P2, P3 points; and the ICVCS sub-index;
- the P4, P5, P6 points; and the IRCS sub-index and the DSRE index;
- point P7; and sub-indices IRB, IRCS, ISIS;
- point P8; and sub-index IRHRS.

The DSRE and RB indices and the RB sub-indices are calculated from the dose rate measurements at the beginning of the shutdown. These data do not allow the characterisation of the dosing deposits, and therefore the origin of the Source Term at the origin of the dose rates to be known.

The CZT measurements allow the deposits which induce radiation doses to be characterised, they do not allow the dose rates to be measured. It is the complement of this information (CZT + dose rate) which provides the assurance or not of a normal and expected status of the contamination of any unit and its evolution throughout time. When the results obtained and their evolution do not comply with what was expected it might sometimes be appropriate to:

- take appropriate measures to avoid the worsening of the radiological conditions;
- implement the decontamination solutions that are adequate for the type of contaminant and circuit; and
- understand and correct the impact of operating hazards which would be penalising with regard to the shutdown doses.

Table of the measurements required to diagnose contamination of the primary cooling system

OPTIMISED CZT PROGRAMME			IRB
P1 P2 P3	CVCS circuit	<ul style="list-style-type: none"> - Upstream from purification - Downstream from purification - Heat exchanger 	ICVCS
P4 P5 P6	RCS circuit	<ul style="list-style-type: none"> - Crossover leg - Hot leg - Leg 	IDSRE, IRCS
P7	RCS/SIS	<ul style="list-style-type: none"> - Check valve 	IRB, IRCS, ISIS
P8	RHRS	<ul style="list-style-type: none"> - Heat exchanger 	IRHRS

Systematic CZT measurement programme during Shutdowns illustration for the Belleville NPP

P1: CVCS - Upstream from purification



P2: CVCS - Downstream from purification

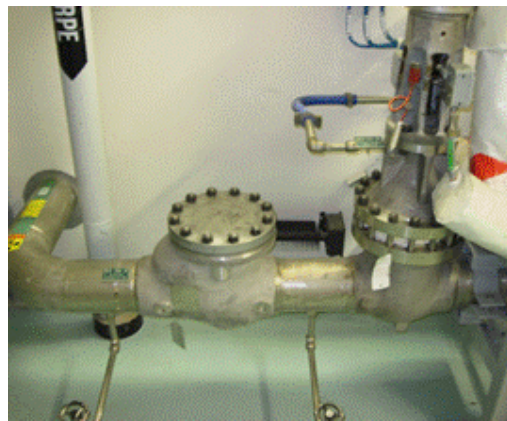

P3: CVCS - Non regenerative heat exchanger

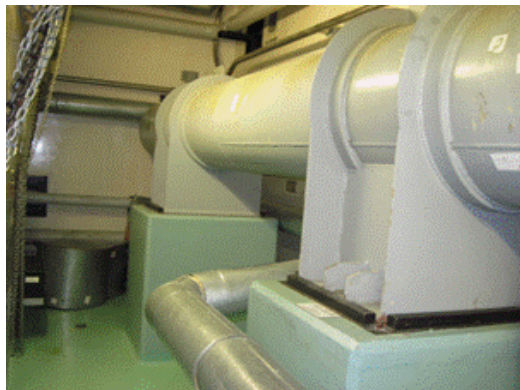

P4: RCS - Crossover Leg



Systematic CZT measurement programme during Shutdowns illustration for the Belleville NPP

P5: RCS - Hot Leg



P6: RCS - Cold Leg

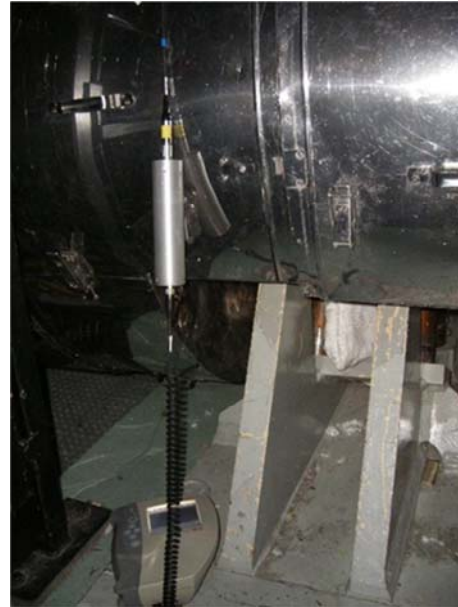

P7: RCS/SIS - Valve



P8: RHRS - Heat exchanger



Appendix 3

ISOE Programme Information

ISOE was created in 1992 to improve the management of occupational exposures at nuclear power plants through the collection and analysis of occupational exposure data and trends, and through the exchange of lessons learned among utility and national regulatory authority experts. Since then, the system has grown continuously and now provides participants with a comprehensive resource for optimising occupational exposure management at nuclear power plants worldwide.

Membership in ISOE includes representatives from nuclear electricity utilities and national regulatory authorities who participate under the ISOE Terms and Conditions. The ISOE programme includes the participation of utilities and regulatory authorities in 29 countries. The ISOE database itself contains information on occupational exposure levels and trends at 470 reactor units worldwide (396 operating units; 74 in under decommissioning), covering about 91% of the world's operating commercial power reactors. To find out more about the ISOE programme: www.isoe-network.net

ISOE is jointly sponsored by the OECD Nuclear Energy Agency (NEA) and the International Atomic Energy Agency (IAEA). ISOE operates in a decentralised manner. A Management Board of representatives from all participating countries, supported by the joint NEA and IAEA Secretariat, provides overall direction.

ISOE Joint Secretariat

OECD Nuclear Energy Agency (NEA)

ISOE Joint Secretariat
12, boulevard des Îles,
F-92130 Issy-les-Moulineaux, France
Tel: +33 1 45 24 10 45
Email: Halilburcin.Okyar@oecd.org

International Atomic Energy Agency (IAEA)

ISOE Joint Secretariat
RSM-NSRW, IAEA
Wagramer Strasse 5, P.O.Box 100, A-1400 Vienna, Austria
Tel: +43 1 2600 26173
Email: J.Ma@iaea.org

Four ISOE Technical Centres (Europe, North America, Asia and IAEA) manage the programme's day-to-day technical operations, serving as contact point for the transfer of information from and to participants.

ISOE Technical Centres

Asian Technical Centre (ATC)

Japan Nuclear Energy Safety Organisation
TOKYU REIT Toranomon Bldg. 8th Fl.
3-17-1 Toranomon, Minato-ku, Tokyo 105-0001, Japan
Tel: +81 3 4511 1953
Email: hayashida-yoshihisa@jnes.go.jp

European Technical Centre (ETC)

Centre d'étude sur l'évaluation de la protection dans le domaine nucléaire (CEPN)
28, rue de la Redoute, F-92260 Fontenay-aux-Roses, France
Tel: + 33 1 55 52 19 39
Email: schieber@cepn.asso.fr

IAEA Technical Centre (IAEA TC)

RSM-NSRW
International Atomic Energy Agency
Wagramer Strasse 5, P.O.Box 100, A-1400 Vienna, Austria
Tel: +43 1 2600 26173
Email: J.Ma@iaea.org

North American Technical Centre (NATC)

RP Department – Cook Nuclear Plant
One Cook Place, Bridgman, Michigan 49106, USA
Tel: +1 269 465 5901 x2305
Email: dwmiller2@aep.com

Appendix 4

ISOE Expert Group on Water Chemistry and Source-Term Management (EGWC)

CANADA

Colin PRITCHARD	Bruce Power
David E. MILLER	Bruce Power

FRANCE

Alain ROCHER	<i>Electricité de France</i>
Chair of the EGWC	(French Electricity Utility – EDF)
Gilles RANCHOUX	<i>Electricité de France</i>
	(French Electricity Utility – EDF)
Ludovic VAILLANT	<i>Centre d'étude sur l'Evaluation de la Protection dans le domaine Nucléaire</i>
	(Nuclear Protection Evaluation Centre – CEPN)
	ISOE European Technical Centre

SLOVAK REPUBLIC

Ivan SMIEŠKO	Bohunice Nuclear Power Plant
--------------	------------------------------

SWEDEN

Mattias OLSSON	Forsmarks Kraftgrupp AB
----------------	-------------------------

UNITED STATES OF AMERICA

Daniel M. WELLS	Electric Power Research Institute (EPRI)
David L. PERKINS	Electric Power Research Institute (EPRI)
David W. MILLER	ISOE/NATC Regional Director
	Cook Nuclear Power Plant
Willie HARRIS	Exelon Nuclear

References

- [1] Hussey D. (2007) Impacts of CVCS Clean up Systems on Activity Release and Dose Rates, June 2007, EPRI Condensate Polishing Workshop, Palm Springs, CA.
- [2] Source Term Reduction: Impact of Plant Design and Chemistry on PWR Shutdown Releases and Dose Rates, EPRI, Palo Alto, CA: 2006, 1013507
- [3] Carrette F. *et al.* (2006) Impact of the Surface State of Steam Generator Tubes on the Release of Corrosion Products in Pressurized Water Reactors, NPC 2006
- [4] Surface Analysis of Pressurized Water Reactor Steam Generator Tubing Specimens: updated review of results obtained from the ID Surfaces of EDF tubes pulled between 1985 to 1990, EPRI, Palo Alto, CA: 1018593
- [5] Radiation Field Control Manual, EPRI, Palo Alto, CA: 2004. TR-1003390
- [6] Cobalt Reduction Sourcebook. EPRI, Palo Alto, CA: 2010. 1021103.
- [7] U.S. Patent No. 4,636,266 "Reactor Pipe Treatment" Jan 13, 1987
- [8] Bachet M. *et al.* (2010) Cleaning the primary circuit after the first high temperature oxidation of steam generator tubing: Why and how to do it, NPC 2010
- [9] Leclercq S. and M. Bachet (2012) SG tubes Pre-oxidation and Cleaning – Effect on Release and Oxides Formation, EDF – France, NPC 2012, Paris
- [10] Ranchoux G. *et al.* (2012) Optimized high temperature oxidation and cleaning at Bugey 3, NPC 2012, Paris
- [11] Uehiar A. and K. Manabu (2011) SG Tubes with SM-ARTTM Technology for Reducing Metal Release in PWR. 2011 ISOE North American ALARA Symposium. EPRI Radiation Protection Conference, Ft. Lauderdale, FL, January 2011.
- [12] Analysis Report on 1999-2001 Field Experience with Elevated, Constant pH, EPRI, Palo Alto, CA: 2001. 1003153.
- [13] Bretelle J-L. (2004) EDF strategy for the primary coolant pH, NPC 2004
- [14] Rocher A. *et al.* (2002), Impact of Main Radiological Pollutants on Contamination Risks (ALARA) Optimisation of Physico Chemical Environment and Retention Technics during Operation and Shutdown, ISOE Symposium, Portoroz, 2002
- [15] Optimisation of Water Chemistry to Ensure Reliable Water Reactor Fuel Performance at High Burnup and in Ageing Plant (FUWAC), IAEA CRP Programme 2006-2009, TECDOC 1666 (October 2011)
- [16] Svarc V. *et al.* (2006) Primary Water Chemistry of VVER Reactors: Comparison of Loop Experiments with Hydrogen, Ammonia and Zinc. International Conference on Nuclear water Chemistry in Reactor Systems, Jeju, Korea, October 2006
- [17] Vonkova K. *et al.* (2011) Operation Experience With Elevated Ammonia, Int. Conf. on Water Chemistry of Nuclear Reactor Systems, Quebec City, Canada, October 2011
- [18] Pashevich V.I. Thermal Engineering 31 (11), 595, 1984

- [19] Pashevich V.I. *Thermal Engineering* 32 (11), 29, 1985
- [20] Smiesko I. and I. Skorvaga (2008) Influence of operational and shutdown chemistry to dose rate build-up at VVER-440 units, *Int. Conf. on Water Chemistry of Nuclear Reactor Systems*, Berlin, 2008
- [21] Vonkova K. *et al.* (2011) Hot Functional Test Chemistry- Long Term Experience, *Int. Conf. on Water Chemistry of Nuclear Reactor Systems*, Quebec City, Canada, October 2011
- [22] BWRVIP-190: BWR Vessel and Internals Project – BWR Water Chemistry Guidelines – 2008 Revision, EPRI, Final Report, October 2008, 1016579
- [23] Wikmark G. and W. Eek (2011) Metod för järndosering i Forsmark, ALARA Engineering Report 11-0018R, 2011
- [24] Experience with Depleted Zinc Oxide Injection in BWRs – 1999 Progress Report, EPRI Interim Report, June 1999, TR-108741
- [25] Björnsson S. *et al.* (2010) Systemtors upptag av Co-60 i närvaro av andra metalljoner, Etapp 4 – inverkan av olika kvoter järn/zink, Studsvik Report Studsvik/N-10/150, 2010
- [26] BWRVIP-107NP: BWR Vessel and Internals Project – Dose Reduction Through Optimizing Chemistry Using Depleted Zinc with Noble Metal, EPRI, Interim Report, April 2004, 1010684
- [27] Okamura M. *et al.* (2005) Corrosion Mitigation of BWR Structural Materials by the Photoelectric Method with TiO₂, *Proceedings of the 12th International Conference on Environmental Degradation of Materials in Nuclear Power Systems – Water Reactors*, TMS, 2005
- [28] Tokyo Electric Power Company and TOSHIBA Corporation, SCC Mitigation by TiO₂ Technique, *E-Journal of Advanced Maintenance (EJAM)*, 2 (4) NT32, 2011
- [29] Full-System Decontamination of a BWR Using the LOMI Process. EPRI, Palo Alto, CA: 1992. TR-100049
- [30] Full System Decontamination of Indian Point 2 PWR. EPRI, TR-107039
- [31] Stiepani C. (2010) Full System Decontamination – Sustainable Dose Reduction for Operating Nuclear Power Plants, *ISOE International Symposium*, Cambridge, UK, 17-19 November 2010
- [32] Stellwag B. *et al.* (2012) FSD for operating NPPs as Part of Sustainable Dose Reduction – Recontamination Evaluation for German PWR Grafenrheinfeld, *International Nuclear Plant Chemistry Conference*, Paris, September 23-27 2012, p.O05-162.
- [33] Wahlstrom B. and U. Linden (1995) Radiological aspects of a full-system decontamination of Loviisa 2, *BNES Conference on Radiation Dose Management in the Nuclear Industry*, Cumbria , October 1995
- [34] Rosenberg R.J. *et al.* (1996) Investigation of iron deposits on fuel assemblies of the Loviisa 2 VVER-440 reactor, “Water chemistry of nuclear reactor systems 7” *Proceedings of the conference organised by the British Nuclear Energy Society*, Bournemouth on 13-17 October 1996 British Nuclear Energy Society, London. p.27-33
- [35] NEMES I. (2003) (NPP Paks, Hungary), Hydraulic anomaly and its management on Paks NPP VVER-440 units in 2002-2003. In *Proc. “Fifth International Conference on VVER Fuel Performance, Modelling and Experimental Support”*, Albena, Bulgaria, Sep. 28 – Oct. 3, 2003.
- [36] Decontamination Handbook. EPRI, Palo Alto, CA: 1999. TR-112352

- [37] Application of the EPRI Standard Radiation Monitoring Program for PWR Radiation Field Reduction. EPRI, Palo Alto, CA: 2007. 1015119.
- [38] Szabó J. and P. Raics, P. (1993) "In Situ Corrosion Monitoring for Primary Loops", Nuclear Engineering International, Oct 1993 p.49
- [39] Raics P. et al. (2006) Investigations on Transport Processes in Primary Circuit of PWRs by In-Situ Gamma-Spectrometry, Int. Conf. on Water Chemistry of Nuclear Reactor Systems, Jeju, Korea, October 2006
- [40] Lundgren K. (1982) Forsmark 1, och 2 – MADAC – Mätpunkter, Asea-Atom Memorandum KPC 82-34, 1982
- [41] Duniec S., (1987) Forsmark 3, Oskarshamn 3 – MADAC – mätpunktsbeskrivning, Asea-Atom Report RM 87-873, 1987