



# Design of Steel Concrete Structures

Technical Direction of EDF, Civil Engineering section.

[Julien.niepceron@edf.fr](mailto:Julien.niepceron@edf.fr) ; AFCEN Working Group Leader n°8



# SUMMARY OF THE PRESENTATION

- The Nuclear Power Plant codification at AFCEN ?
- Introduction : Why Steel Concrete Structures could be a solution ?
- Progress of Steel-Concrete Structures knowledge at EDF .
- Iterations in the design process
- Example of the iteration design process with the fire loading.



## WHAT IS AFCEN ?

AFCEN\* is an association founded by EDF and FRAMATOME

Main objectives were initially to:

- develop, update and publish design, construction and operation-maintenance rules for structures and components of nuclear facilities;
- ensure that certified trainings are provided to the users of the AFCEN codes.

The sub committee of RCC-CW consists of a steering committee led by a chairman (Guillaume ZAMMOUT) and 8 working groups steered by WOG Leaders.

- WOG 1: Safety, design and structure of code;
- WOG 2: Geotechnics, soils and buried structures;
- WOG 3A: Reinforced and pre-stressed concrete structures (*Design*);
- WOG 3B: Reinforced and pre-stressed concrete structures (*Construction*);
- WOG 4: Containment and pool liners, storage tanks;
- WOG 5: Metal frame structures;
- WOG 6: Anchorages;
- WOG 7: Tests and monitoring
- WOG 8: Steel concrete structures

*\*Association française pour les règles de conception, de construction et de surveillance en exploitation des matériels des chaudières électro-nucléaires*

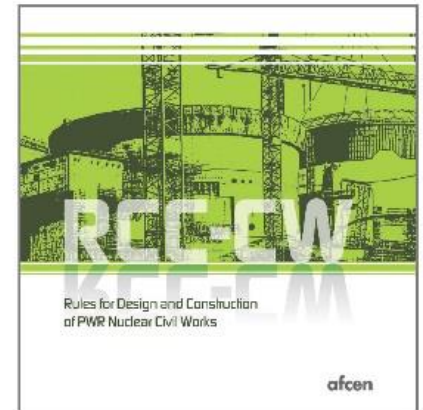

**RCC-CW**

## Introduction : Why Steel-Concrete Structure could help ?

- Improving safety in the design of nuclear power plants requires taking into account increasingly extreme internal or external hazard scenarios, which, coupled with increasingly severe dimensioning criteria, result in a dimensioning of more and more imposing ... The result is an increasingly long construction time. (Average reinforcement on the EPR is about 250 kg/m<sup>3</sup> and locally 500 kg/m<sup>3</sup>).
- In this context the use of Steel Concrete Structures could be one of the answer to improve the construction planning schedule.



# ITERATION DESIGN PROCESS

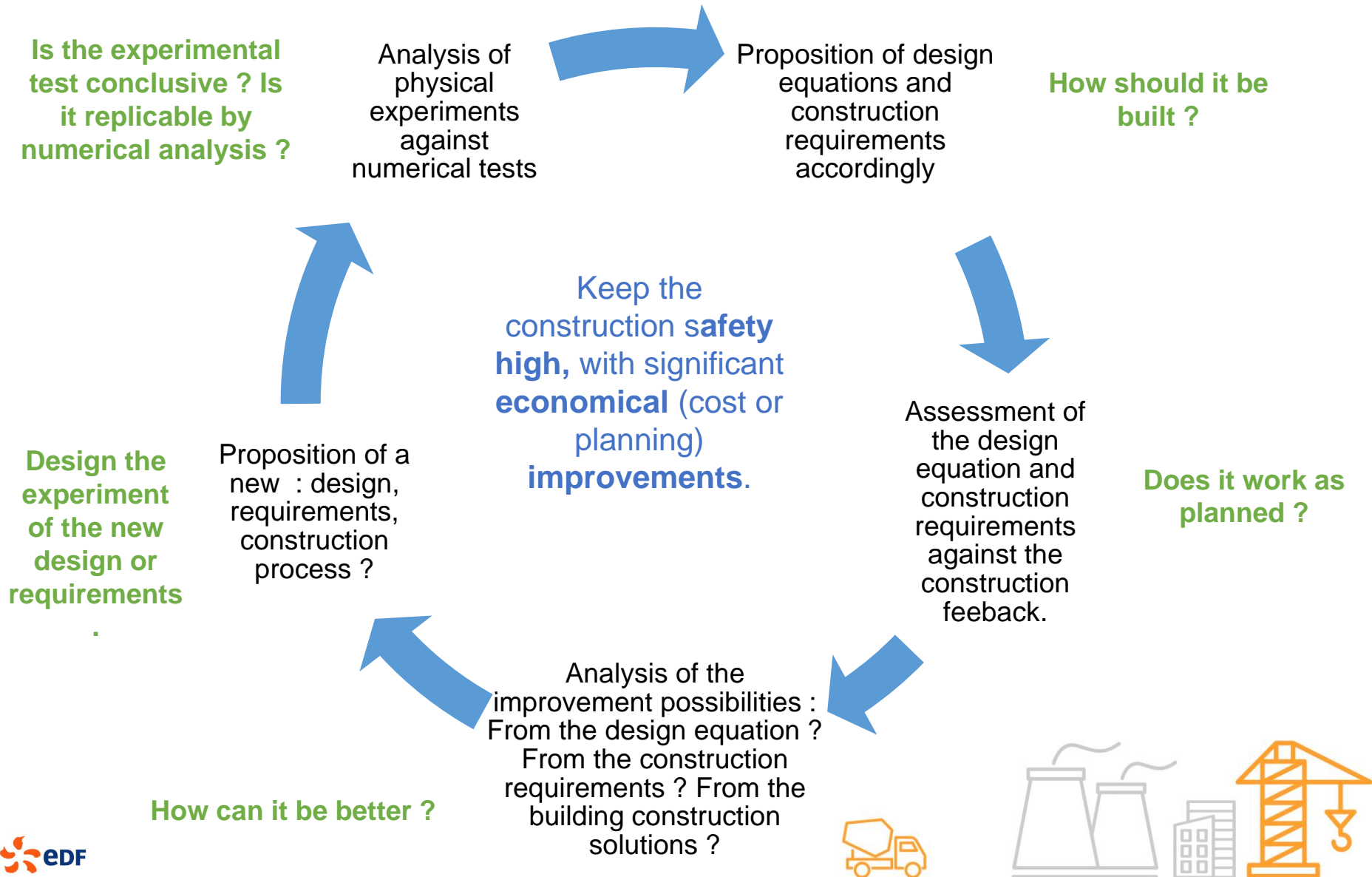

# DEVELOPMENT OF CONCRETE STEEL STRUCTURES AT EDF

2012 2013 2014 2015 2016 2017 2018 2019 2020 2021 2022 2023 2024 2025

SCIENCE

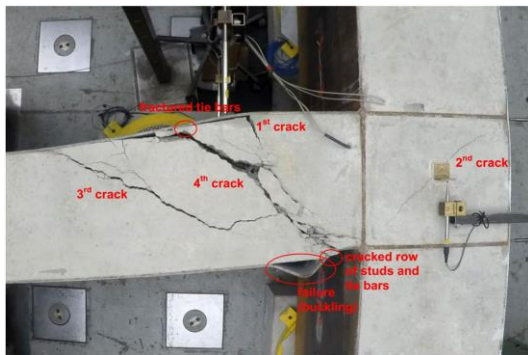
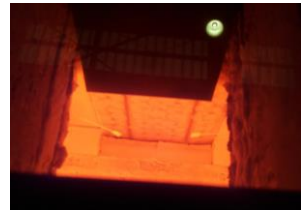
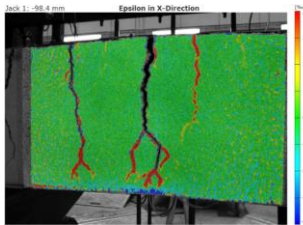

DESIGN OF STEEL CONCRETE COMPOSITE (SC) STRUCTURES

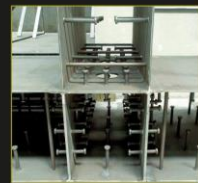

SAM

SCHEDULE

RCC-CW Design

RCC-CW Construction

CODE ASTER

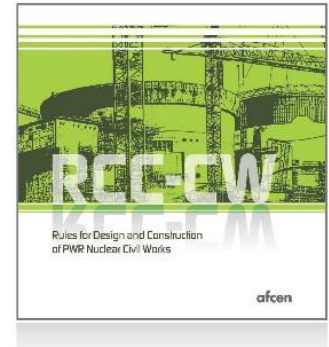

Vue en perspective de la maquette SAM et des équipements d'essais associés

SAM : 5 x 5 x 5 m / 100 T

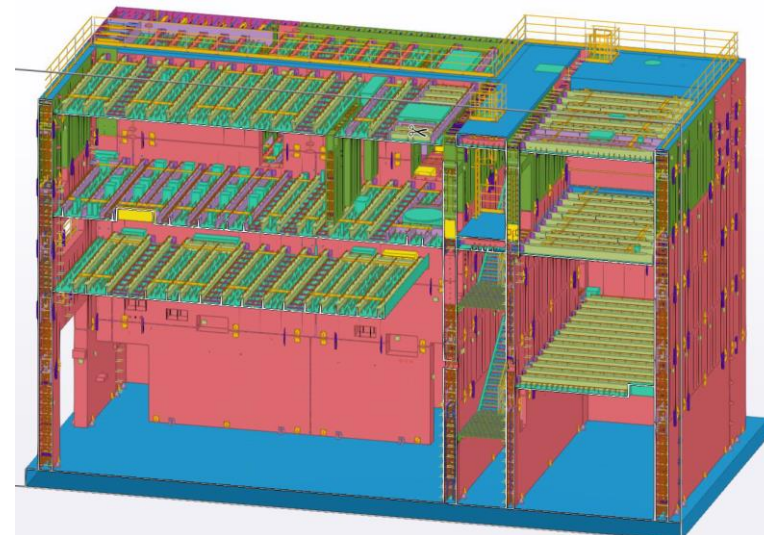

SCHEDULE : 23 m x 20 m x 13 m / 2500 T

# EXAMPLE OF THE ITERATION PROCESS OF THE FIRE DESIGN OF SCS FLOOR

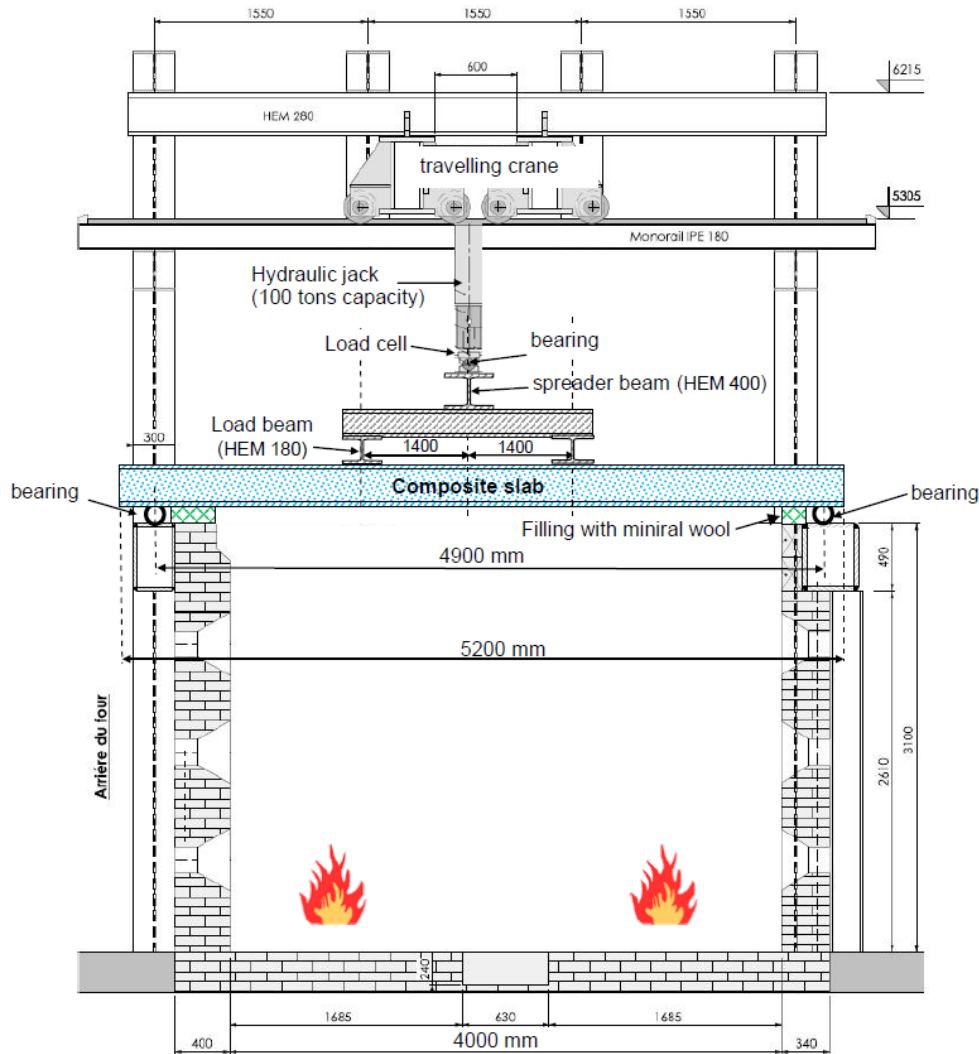
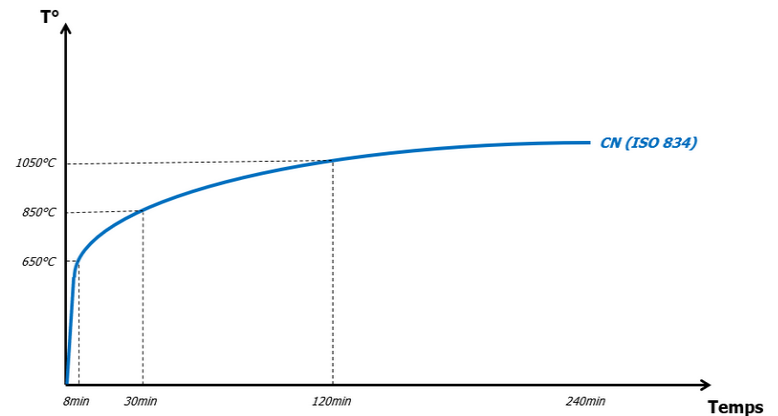

Figure 1 : Arrangement of slabs in the test furnace - side view

The thermal action has been applied according to the standard **ISO-834** fire curve.



How do we design such floor in Steel Concrete ?



# EXAMPLE OF THE ITERATION PROCESS OF THE FIRE DESIGN OF SCS FLOOR

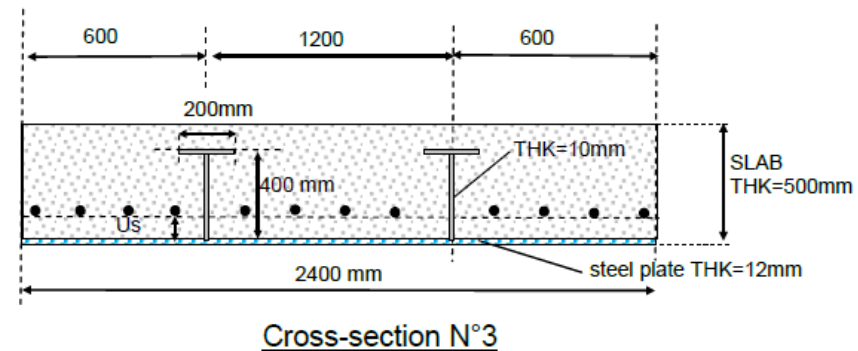
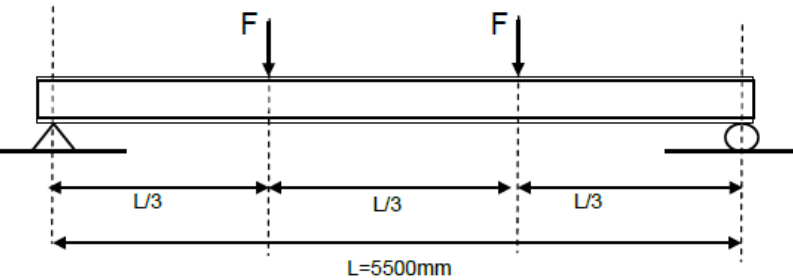
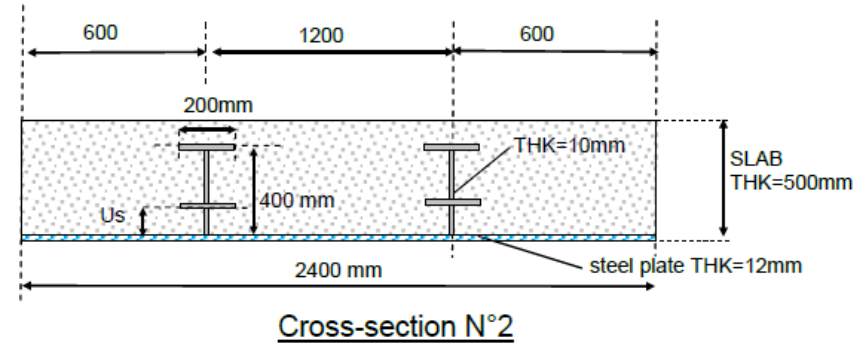
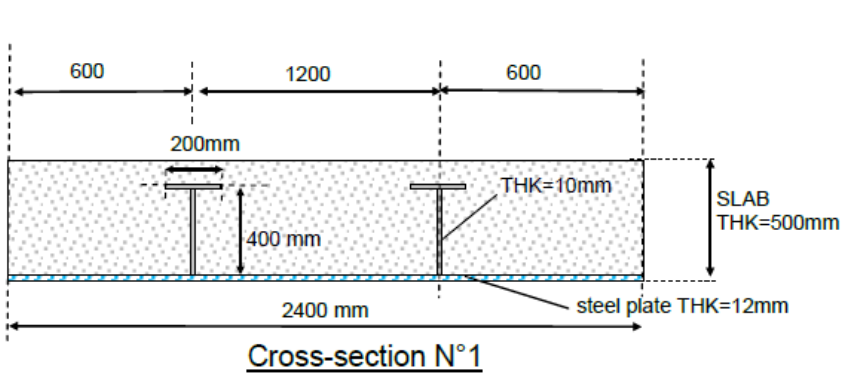

Let's imagine what sort of design could work ... with the objective to not use any fire protection.



# EXAMPLE OF THE ITERATION PROCESS OF THE FIRE DESIGN OF SCS FLOOR

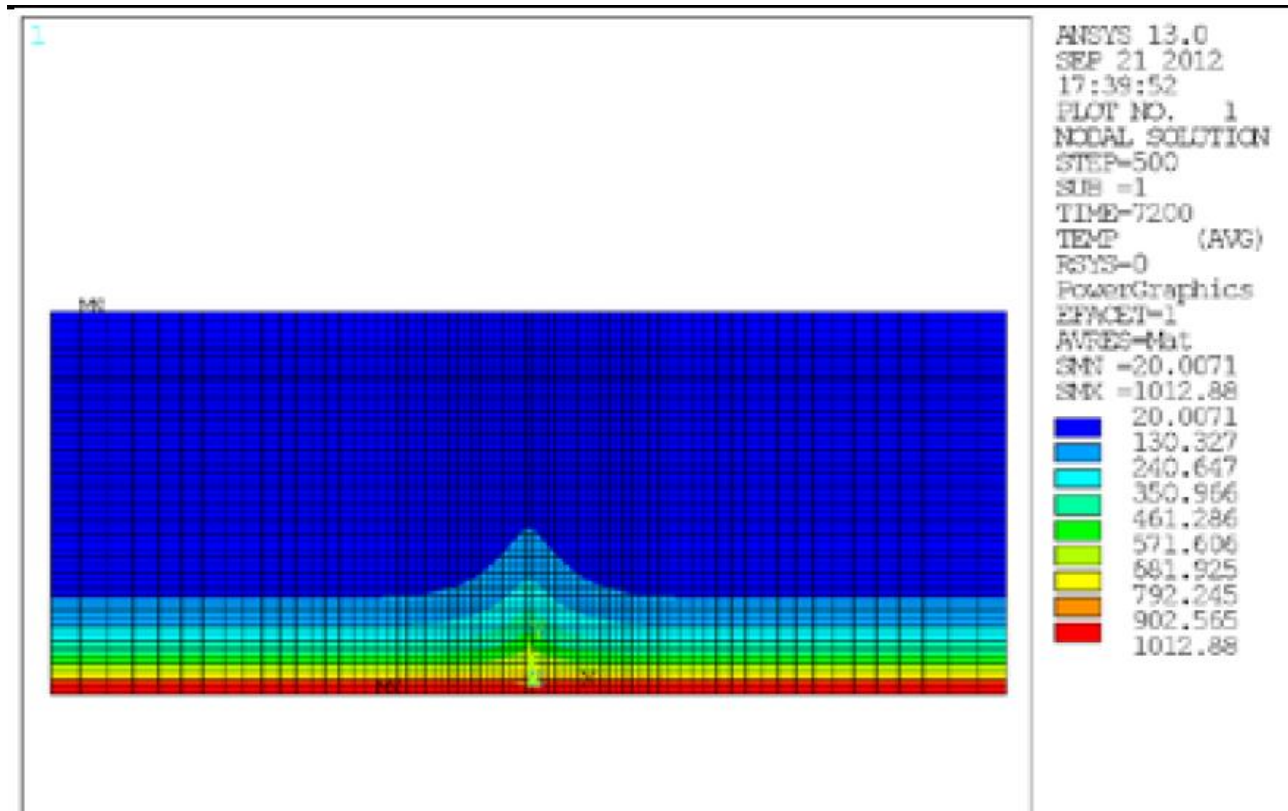

Thermal profile in the cross section after 2h of fire ISO 834.

# EXAMPLE OF THE ITERATION PROCESS OF THE FIRE DESIGN OF SCS FLOOR

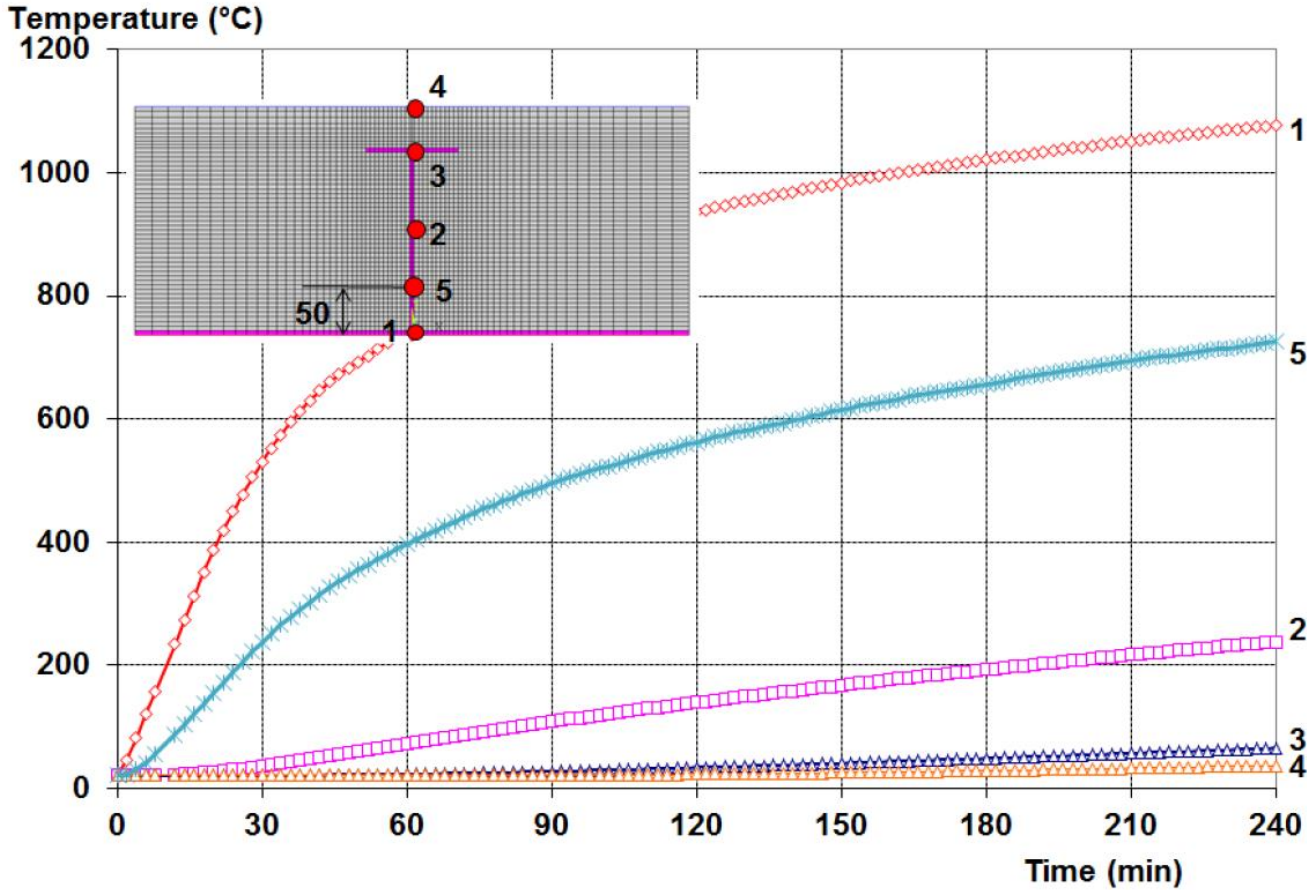

Temperature along the T stiffener up to 4h of fire ISO 834.

# EXAMPLE OF THE ITERATION PROCESS OF THE FIRE DESIGN OF SCS FLOOR

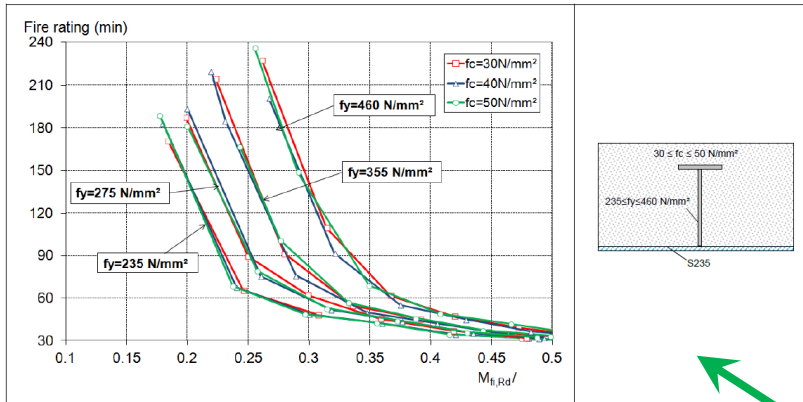

Figure 17: Fire resistance of the slab type n°1 according to the fire load level and material grades

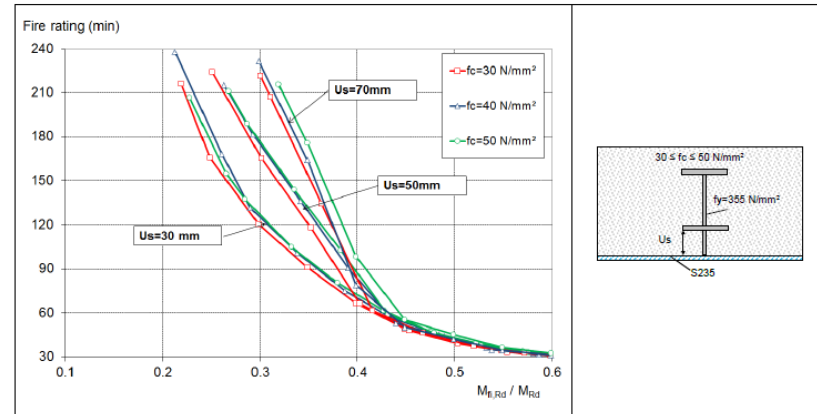

Figure 19: Fire resistance of the slab type n°2 according to the fire load level assuming a steel grade S355 for all embedded steel parts

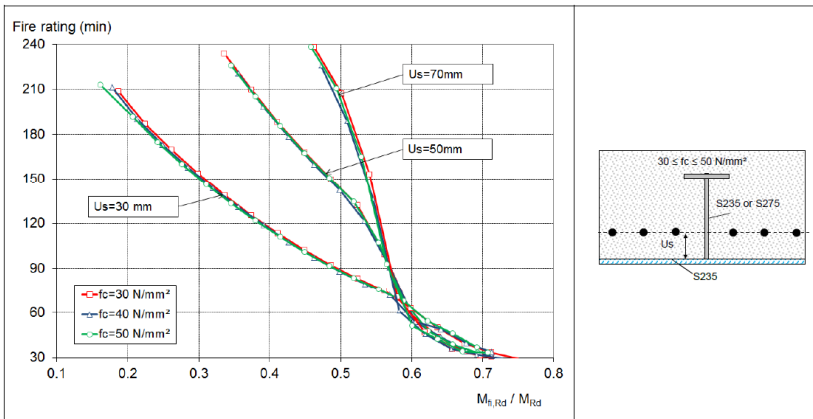

Figure 21: Fire resistance of the slab type n°3 with 1% of reinforcement ratio according to the fire load level

The simplest design could be enough for our mechanical requirements ! Let's keep this one !

# EXAMPLE OF THE ITERATION PROCESS OF THE FIRE DESIGN OF SCS FLOOR



# EXAMPLE OF THE ITERATION PROCESS OF THE FIRE DESIGN OF SCS FLOOR



# EXAMPLE OF THE ITERATION PROCESS OF THE FIRE DESIGN OF SCS FLOOR

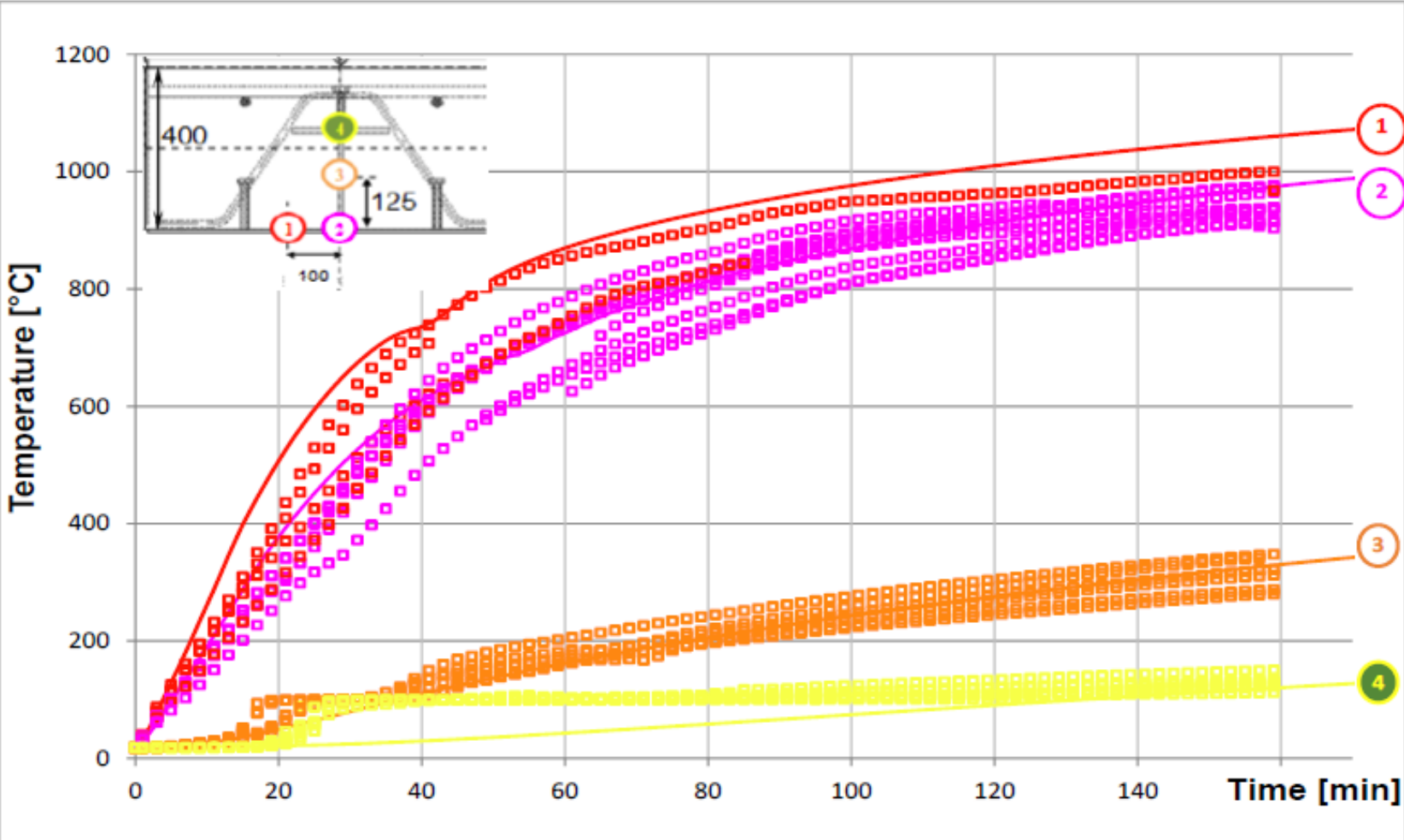

# EXAMPLE OF THE ITERATION PROCESS OF THE FIRE DESIGN OF SCS FLOOR

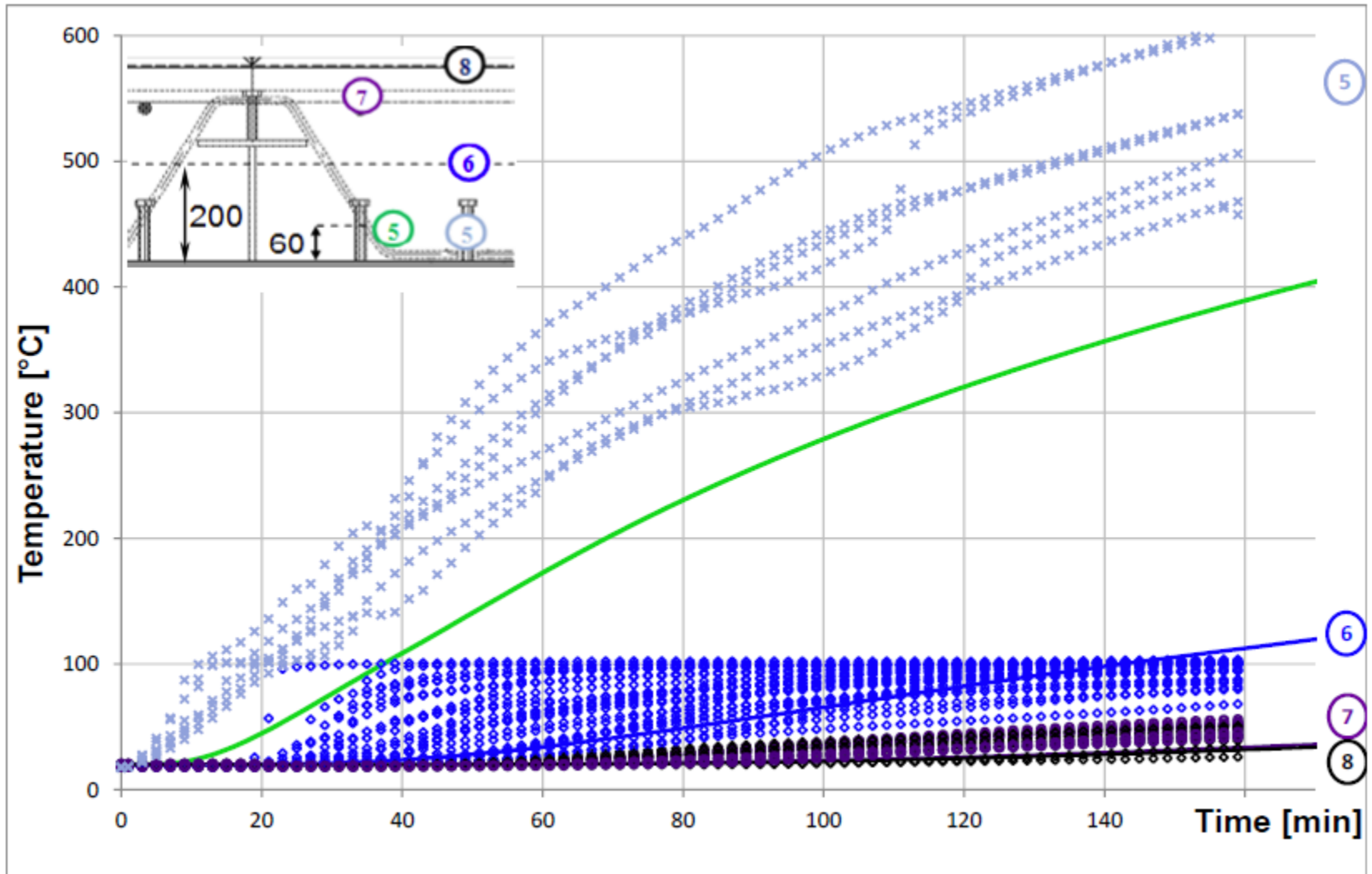

# EXAMPLE OF THE ITERATION PROCESS OF THE FIRE DESIGN OF SCS FLOOR

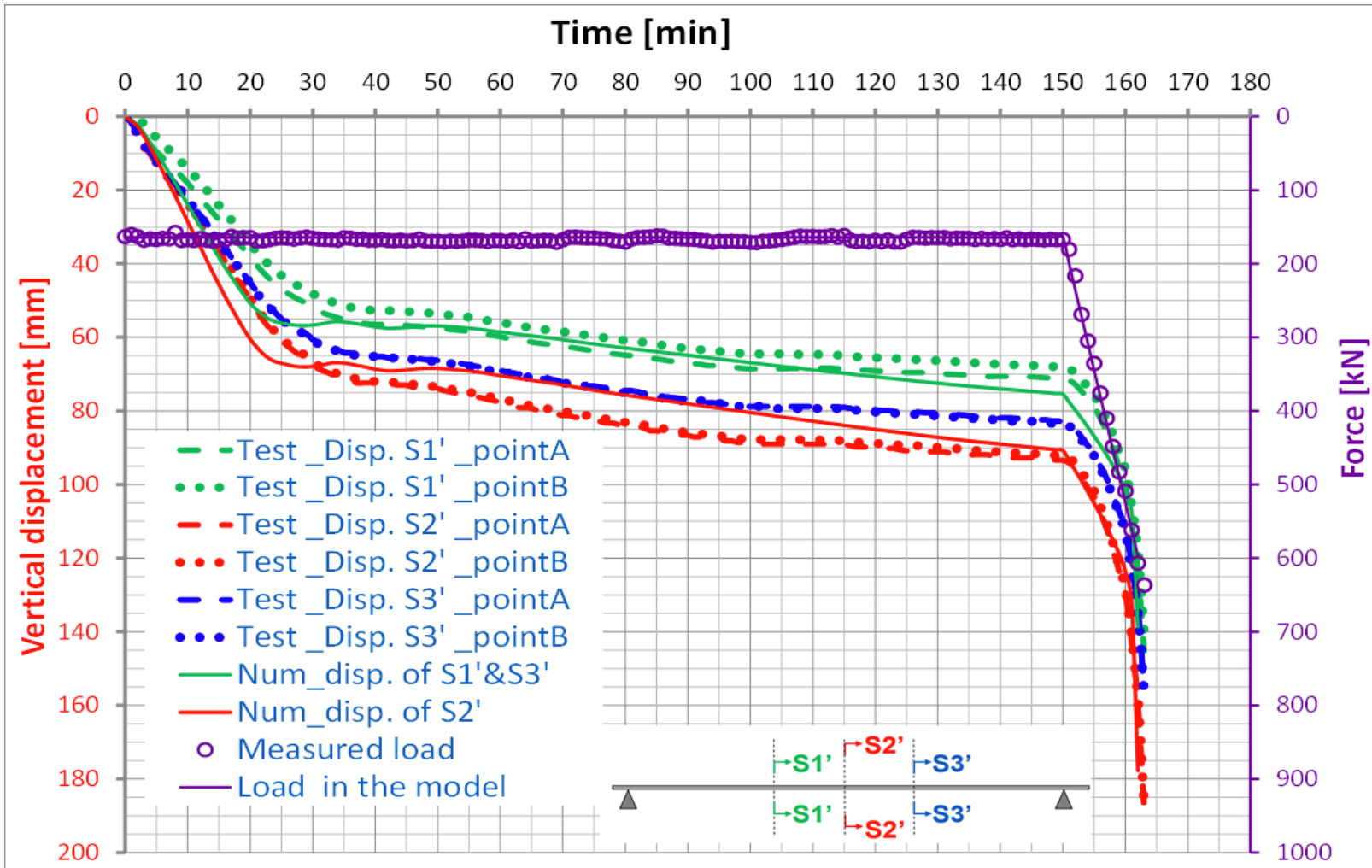



# EXAMPLE OF THE ITERATION PROCESS OF THE FIRE DESIGN OF SCS FLOOR

## Strength reduction of steel

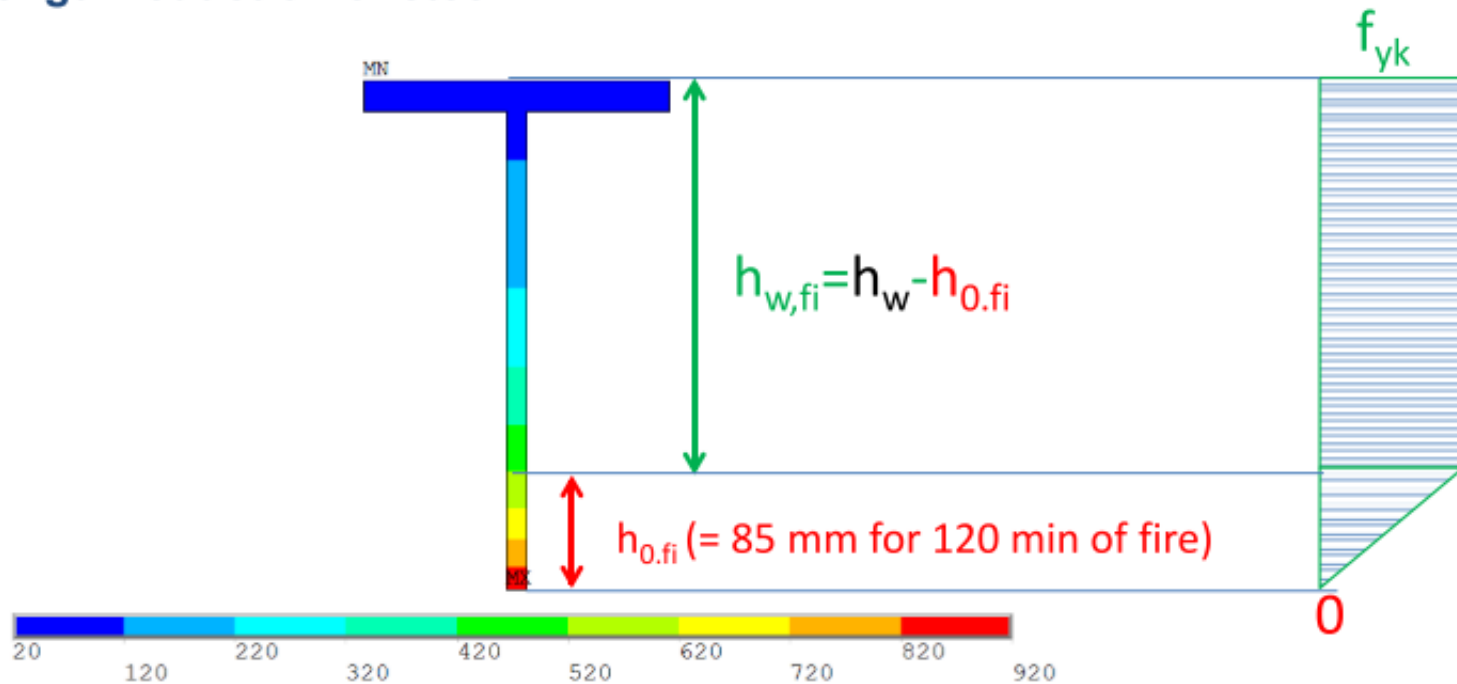

The strength of bottom plate is neglected due to its very high heating level

The strength of steel web can be interpolated linearly from 0 to  $f_{yk}$  over the height  $h_{0,fi}$  from bottom plate. Above this height, steel strength can be taken



# EXAMPLE OF THE ITERATION PROCESS OF THE FIRE DESIGN OF SCS FLOOR

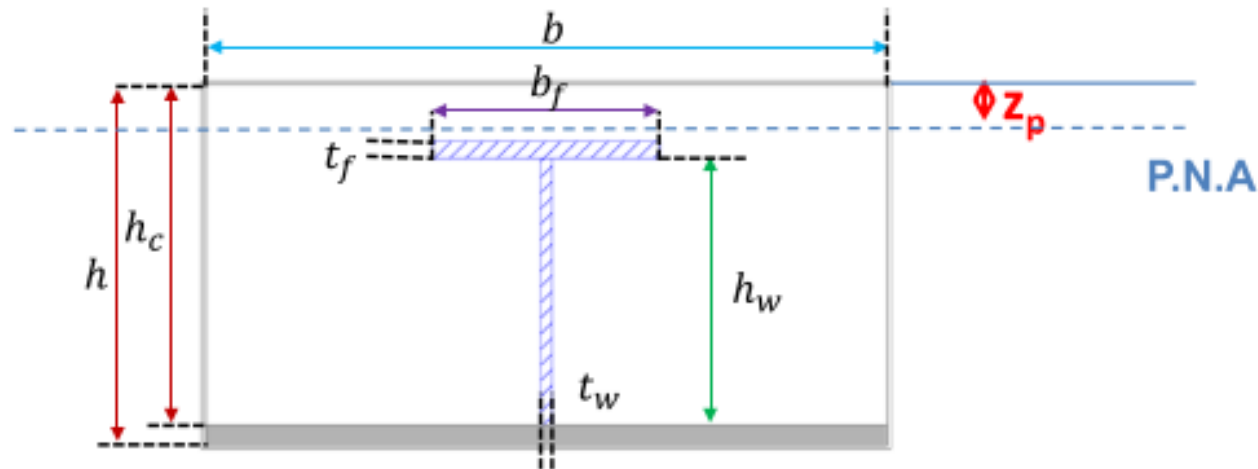

Case where P.N.A is located above T-profile (common case):

$$z_p = \frac{[f_{yk}(t_f b_f) + f_{yk} t_w (h_w - t_f - h_{0,fi}) + 0.5 f_{yk} t_w h_{0,fi}]}{f_{cd,fi} b}$$

$$M_{Rd,fi}^+ = 0.5 f_{yk} t_w h_{0,fi} (h_c - 0.5 z_p - \frac{2}{3} h_{0,fi}) + f_{yk} t_w h_{0,fi} (h_c - 0.5 z_p - 0.5 (h_w - t_f - h_{0,fi})) + f_{yk} (t_f b_f) (h_c - 0.5 z_p - h_w + 0.5 t_f)$$

## EXAMPLE OF THE ITERATION PROCESS OF THE FIRE DESIGN OF SCS FLOOR

- The tests carried out are conclusive on the fire resistance performance of the SC elements designed upstream
- The numerical models are based on the proposals of the Eurocodes and are improved in the calibration studies with the results of the tests in a fire situation within the framework of this SCIENCE project.
- Parametric studies are carried out around the maximum loads and spans of EDF's target building elements. Thus, simplified methods are proposed to check SC floor and wall elements in a fire situation (more particularly at 120 minutes of ISO fire).
- The proposed simplified calculation methods are safe and fast method to assess the fire design.





# Workshop on Advanced Construction & Manufacturing Methodologies for New Nuclear Build

**Stephanie Smith,  
President & CEO, CANDU Owners Group  
March 17, 2022**

# COG's Role – Excellence & Innovation through Collaboration

## Members



Founded in Canada in 1984

## 45 operating CANDU units across 7 countries, worldwide

- Canadian technology with international reach
- Between \$60-\$70 million annually in R&D and member-initiated projects
- Private, not-for-profit corporation
- Enables safe, reliable, cost-effective and environmentally-sound operation through knowledge and resource sharing

## CANDU and Beyond Performance Excellence and Industry Sustainability

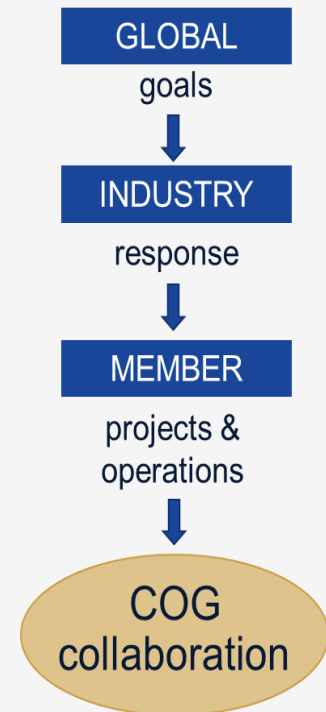

# Advanced Manufacturing Roadmap

Last year COG contributed to the Advanced Manufacturing Roadmap for the Canadian Nuclear Industry

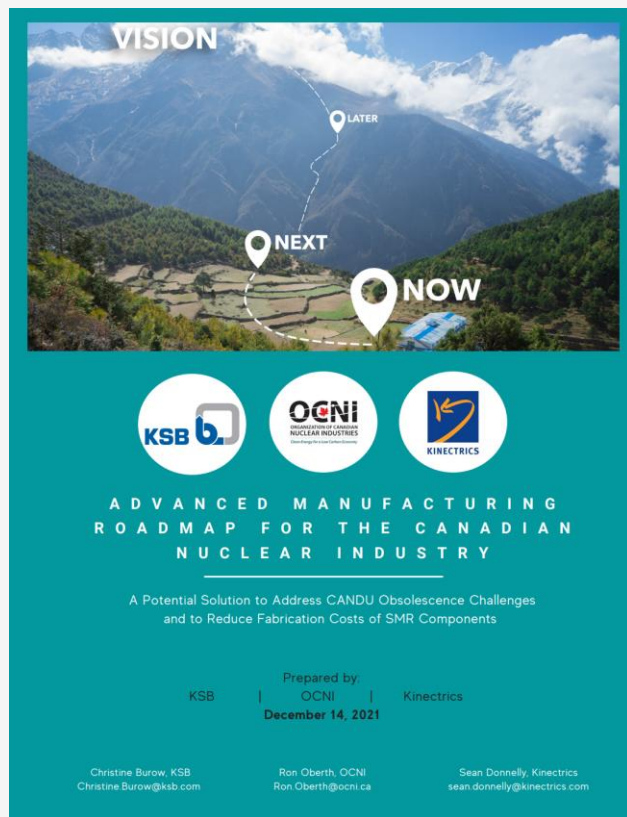

- High-level plan to develop Advanced Manufacturing capacity in the Nuclear Supply Chain
- Additive manufacturing as starting point
- To support existing fleet of CANDU reactors to 2065 and beyond, and the deployment of Small Modular Reactors

# Advanced Manufacturing Roadmap

## Expected benefits

- **Obsolescence.** 3D-printing of obsolete parts not available because OEM not in business
- **Reduced lead times.** Quicker manufacturing and post-processing times.
- **Higher efficiency.** Cost-effective reproduction of parts with complex geometries.
- **Waste reduction.** Optimized use of expensive materials.
- **Digital parts warehouse.** Virtual catalogue of often required parts.
- **Small Modular Reactors.** Manufacturing of part with complex geometries, leading to greater efficiencies, decreased weight and smaller size.

# CANDU Components & Innovation

## **Advanced manufacturing techniques are investigated for**

- 3D – printed obsolete components
- 3D – printed stainless steel feeder
- Advanced coatings for corrosion protection
- Advanced high strength and lightweight materials

## **Innovation centres**

- X-lab in Ontario Power Generation Inc.
- Nuclear Innovation Institute in Bruce Power LP



# Case Study: COG Reduced Outages Supplier Innovation Workshop

- Fall 2021: Held a *Dragon's Den* rapid-pitch style workshop
- Included high-level technical staff
- Presented new initiatives and then ranked them on benefit/readiness/and cost to implement
- Problem solving approach – enable dialogue between developers and end users



**Goal:** Accelerate innovation by bringing supplier solutions to key nuclear utility staff with the know-how to direct the development and implementation of these industry innovations to meet cost and schedule goals

# Collaboration in Codes and Standards

## Harmonization Task Force

- Sponsored by the Canadian Standards Association
- Seek international alignment and eliminate trade barriers
- Codes & Standards must be enablers of new technologies

## Problem Statement

*Developers, manufacturers and operators are challenged with applicability and demonstration of compliance to codes & standards due to differences in requirements between countries and jurisdiction during the life cycle of small modular reactor.*

# Benefits of Collaborative Approach

- Learn from others
- Enable adoption of common approaches and best practices across the sector
- Pooled resources to achieve more at a fraction of the cost
- Sum greater than its parts – all facilities get same access regardless of resources/longevity
- United front - facilitate discussions and alignment on regulatory affairs



**COG  
Excellence  
Through  
Collaboration**

**Discussion**

# CORDEL: A perspective on Advanced Manufacturing Techniques



Ronan Tanguy, CORDEL Programme Lead

NEA Workshop on Advanced Construction  
and Manufacturing Methodologies for  
New Nuclear Build

17<sup>th</sup> March 2022

# World Nuclear Association

- The World Nuclear Association is the international organization that promotes nuclear energy and supports the many companies that comprise the global nuclear industry
- World Nuclear Association membership encompasses all aspects of nuclear energy
- CORDEL working group aims to standardize reactor designs so they can be deployed internationally without major design changes due to national regulations

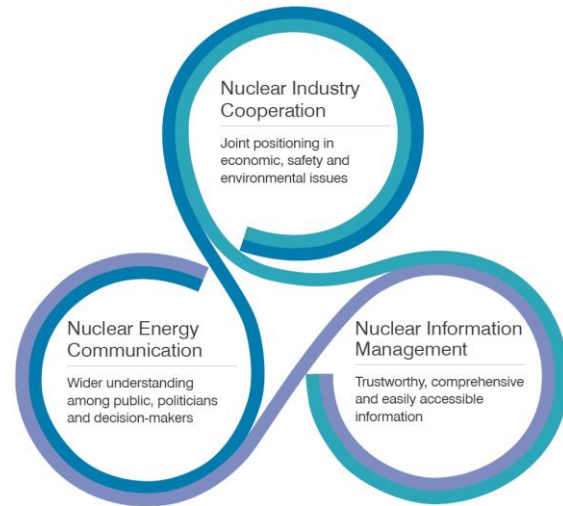

# Cooperation in Reactor Design Evaluation and Licensing (CORDEL) is the industry approach to harmonization

- CORDEL has:
  - Defined the need
  - Developed collaborative relationships with governments and international industry and regulatory fora
  - Addressed some of the specific challenges in relevant reports

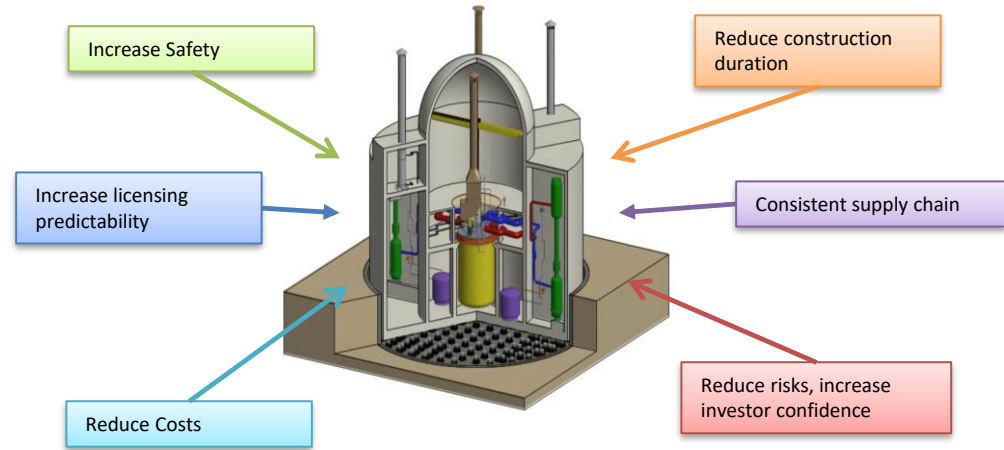

Download them at <https://www.world-nuclear.org/our-association/publications/online-reports.aspx>

# CORDEL Advanced manufacturing project

- Produce a position paper to present current initiatives within member organizations and the challenges they face with regards to regulation and codes & standards.
- Aiming to put forward a consistent industry position and encourage international harmonization of approaches to codification of advanced manufacturing processes and techniques.
- Use the conclusions to guide efforts and engage with standard developing organisations to influence codification, reducing the potential for divergence between countries/codes and standards.
- Report scheduled for publication in Q2 2022





# Selection of WNA member AM initiatives

Item	AM Process	Organization
Channel fastener	Powder bed fusion	Framatome (TVA Browns Ferry)
Heavy shielding	Directed metal deposition	RuSAT
Large and small vessels	Powder metal hot isostatic pressing	NAMRC (NuScale Power)
Pump impeller	Powder bed fusion	Siemens (NEK Krško)
	Powder bed fusion	RuSAT
Thimble plugging device	Powder bed fusion	Westinghouse
Terminal block	Powder bed fusion	Engie Laborelec
Valve (body)	Powder bed fusion	Neles (Fortum & TVO) Engie Laborelec
Vessel cladding	Diode laser cladding	NAMRC (NuScale Power)

# Codes and standards for advanced manufacturing

- Advanced manufacturing techniques are codified in non-nuclear codes and standards (EBW, PM HIP)
- Requirements must be defined to translate these into the nuclear context
- Gaps have been identified:
  - Inconsistent terminology
  - Specifications for raw materials
  - Specifications for products manufactured using a combination of AM and conventional
  - Inspection and NDE
- Codification is needed for regulators to gain confidence in the application of the techniques.
- Code cases are being submitted to ASME but limited to certain materials.

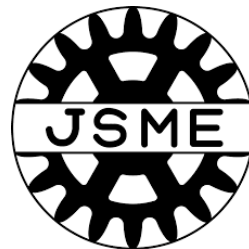
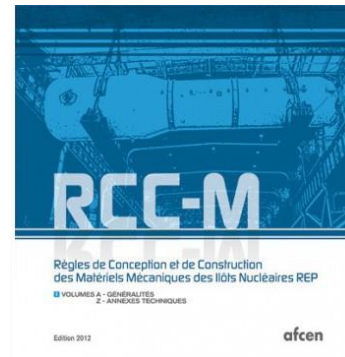
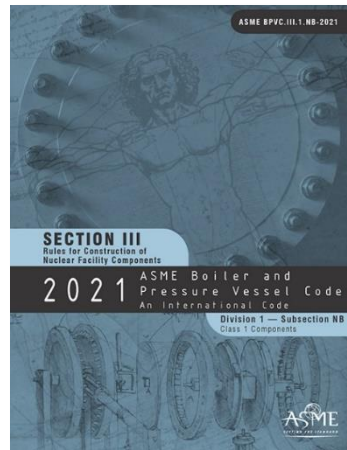

# Codes & Standards/Process qualification

- Process qualification is needed demonstrate that parts can be made in reproducible ways with equivalent properties and quality to traditional manufacturing processes
- Long-term performance of components in nuclear environment is uncertain (thermal ageing, fatigue, irradiation).
- SNETP NUCOBAM project is working to produce a standardized qualification compatible with AFCEN RCC-M, ASME BPVC and EN 13445
  - Raw material procurement
  - Quality control management
  - Heat-treatment
  - Inspection & testing
  - Surface finish



# Conclusions

- Codification and subsequent regulatory approval is key for adoption of advanced manufacturing processes in nuclear supply chains.
- The current gaps in codes & standards present an opportunity to develop them in a harmonized manner and avoid discrepancies.
- International initiatives and cooperation are needed to prevent divergence.
- Harmonization/equivalence of codes & standards and regulation is essential for regional deployment of SMRs.
- CORDEL will continue to advocate for streamlining of practices and take its findings to the SDO Convergence Board for consideration.





[www.world-nuclear.org](http://www.world-nuclear.org)