



High-burnup Experiments in Reactivity Initiated Accidents (HERA)

May 2022

Changing the World's Energy Future



DISCLAIMER

This information was prepared as an account of work sponsored by an agency of the U.S. Government. Neither the U.S. Government nor any agency thereof, nor any of their employees, makes any warranty, expressed or implied, or assumes any legal liability or responsibility for the accuracy, completeness, or usefulness, of any information, apparatus, product, or process disclosed, or represents that its use would not infringe privately owned rights. References herein to any specific commercial product, process, or service by trade name, trade mark, manufacturer, or otherwise, does not necessarily constitute or imply its endorsement, recommendation, or favoring by the U.S. Government or any agency thereof. The views and opinions of authors expressed herein do not necessarily state or reflect those of the U.S. Government or any agency thereof.

High-burnup Experiments in Reactivity Initiated Accidents (HERA)

May 2022

**Idaho National Laboratory
Idaho Falls, Idaho 83415**

<http://www.inl.gov>

**Prepared for the
U.S. Department of Energy
Under DOE Idaho Operations Office
Contract DE-AC07-05ID14517**

Page intentionally left blank

ABSTRACT

HERA is a joint experimental program (JEEP) operating within the Nuclear Energy Agency's (NEA's) framework for irradiation experiments (FIDES). HERA is dedicated to the understanding of light water reactor (LWR) fuel performance at high burnup under reactivity-initiated accidents (RIA). In-pile RIA experiments have been performed on high burnup fuels (above 60 GWD/MTU) in the CABRI reactor in France, and the NSRR reactor in Japan. However, most of these experiments have taken place with heavily corroded Zircaloy claddings with pulse widths that are narrower (5ms – 30ms full-width-half-max (FWHM)) than what would be likely in a commercial LWR (30ms – 80ms FWHM). A few tests were performed in the CABRI facility with FWHM up to 76 ms though only one “blistered” rod experienced cladding failure. Heavy waterside corrosion and narrow pulse widths are both known to increase the vulnerability of LWR fuel to pellet cladding mechanical interaction (PCMI). The HERA proposal is designed to (1) quantify the impact of pulse width on fuel performance, offering new insight into the applicability of existing data, (2) generate new data on high burnup fuel under pulse conditions prototypic of LWRs (3) quantify the additional margin provided by modern cladding alloys to PCMI failure limits and (4) offer improved data for modelers using specially designed tests that eliminate key uncertainties in high-burnup fuel tests.

Page intentionally left blank

CONTENTS

ABSTRACT.....	iii
1. PURPOSE AND OBJECTIVES.....	1
2. PROJECT ORGANIZATION.....	1
3. BACKGROUND.....	2
4. FACILITY DESCRIPTION.....	4
4.1 THE TREAT REACTOR.....	4
4.2 WATER CAPSULE TESTING IN TREAT.....	6
4.3 THE NSRR REACTOR.....	8
5. PULSE WIDTH (PRE-HYDRIDED) IRRADIATIONS.....	10
5.1 FABRICATION AND CHARACTERIZATION OF PRE-HYDRIDED SPECIMENS.....	10
5.2 PRE-HYDRIDED TRANSIENT IRRADIATIONS.....	11
5.3 POST TRANSIENT EXAMINATIONS OF PRE-HYDRIDED IRRADIATIONS.....	12
6. HIGH-BURNUP IRRADIATIONS.....	13
6.1 PRE-TRANSIENT ANALYSIS AND TEST ROD FABRICATION OF HBU RODS.....	13
6.2 HIGH BURNUP TRANSIENT IRRADIATIONS.....	14
7. HERA MODELLING AND SIMULATION EXERCISE.....	15
8. PREPARATIONS FOR HERA PHASE II.....	17
9. SCHEDULE BUDGET AND DELIVERABLES.....	18
10. REFERENCES.....	20

FIGURES

Figure 1. In-Pile RIA Testing Database as a function of Pulse Width.	3
Figure 2. Burnup Distribution of Ballooning and Rupture Failures in RIA Experiments.....	4
Figure 3. Cutaway view of the TREAT reactor.....	6
Figure 4. SERTTA Water Capsule	7
Figure 5. Configuration of the NSRR.....	8
Figure 6. Test fuel rod and test capsules.....	9
Figure 7. Cladding hoop stress during PCMI phase of RIA transients of varying pulse widths.....	16

TABLES

Table 2. Pre-hydrided test rod characteristics.....	10
Table 3. Pre-hydrided test matrix.	11
Table 4. High-burnup test matrix.....	14
Table 5. Past RIA experiments to be simulated using advanced tools as part of HERA.	17
Table 6. HERA Schedule.....	19
Table 7. HERA Budget.....	19

Page intentionally left blank

High-burnup Experiments in Reactivity Initiated Accidents (HERA)

1. PURPOSE AND OBJECTIVES

HERA is a joint experimental program (JEEP) operating within the Nuclear Energy Agency's (NEA's) framework for irradiation experiments (FIDES). The HERA JEEP is designed to understand light water reactor (LWR) fuel performance under reactivity-initiated accidents (RIA). Specifically, the JEEP is intended to:

1. quantify the impact of pulse width on fuel performance, offering new insight into the applicability of existing data;
2. generate new data on high burnup fuel under pulse conditions prototypic of LWRs;
3. quantify the additional margin provided by modern cladding alloys to PCMI failure limits; and
4. offer improved data for modelers using specially designed tests that eliminate key uncertainties in high-burnup fuel tests.

HERA will achieve these objectives through two experimental tasks as well as a modelling and simulation exercise. The first task is associated with the identification of pulse width impacts on hydride assisted Pellet Cladding Mechanical Interaction (PCMI) failure in RIA transients and will be achieved through systematic experiments on pre-hydrided cladding. The second task is to extend the existing empirical database of high-burnup RIA test data particularly to assess post failure phenomena. This second task will involve the transient irradiation of material, which has been previously irradiated in a commercial LWR. Most experiments in HERA will take place at Idaho National Laboratory's (INL's) Transient Reactor Test Facility (TREAT) with some experiments taking place at the JAEA's Nuclear Safety Research Reactor (NSRR).

The modeling and simulation exercise will be directed at evaluating experiment design performance and evaluation of key experiment objectives, focused on both blind predictions and post-test follow-up evaluations. While the HERA project will provide management and logistical support for the modelling and simulation exercise, the actual modelling work will be sought through participation of the broader FIDES community.

2. PROJECT ORGANIZATION

The HERA JEEP organization consists of a core group, operating agent(s), and a project coordinator. The core group will consist initially of the following five organizations. Consistent with the definition of the JEEP Core Group in the FIDES Agreement, each of these organizations will be providing resources needed for the successful execution of the HERA JEEP either through funding or in-kind contributions.

1. the Department of Energy of the United States of America (DOE), also signing on behalf of Idaho National Laboratory (INL);
2. the Nuclear Regulatory Commission of the United States of America (NRC);
3. Westinghouse Electric Company (WESTINGHOUSE);
4. the Japan Atomic Energy Agency (JAEA);
5. the French Institut de radioprotection et de sûreté nucléaire (IRSN).

Roles and responsibilities for the various core group members are discussed in this proposal. The Idaho National Laboratory (INL) will act as the principal Operating Agent as the majority of the experimental work will occur there. Two of the transient irradiations with fresh fuel and pre-hydrated cladding will take place at the NSRR reactor. For those experiments, JAEA will be the Operating Agent.

The HERA JEEP core group will nominate one individual to serve as the HERA JEEP coordinator. The HERA JEEP coordinator will have the principal responsibility of managing and overseeing the project as well as serving as the liaison between the HERA core group, and the FIDES Governing Board, the NEA Secretariat, and the JEEP Advisory Group (JAG) if the FIDES Governing Board decides to establish such a group.

3. BACKGROUND

During RIAs LWR fuel cladding can be breached by one of two mechanisms; pellet-cladding mechanical interaction or high temperature balloon and rupture. Pellet-cladding mechanical interaction (PCMI) failure occurs in the early phase of an RIA transient where the fuel pellet expands rapidly into the cladding prior to meaningful heat transfer from the pellet to the cladding. This results in high stresses in the cladding resulting in crack propagation through the base Zircaloy metal and axially along the cladding tube. Failure by PCMI is a brittle failure mode and occurs at low cladding strains, approximately 2% hoop strain.

If the cladding survives the PCMI phase of the transient, it may still fail due to ballooning and rupture induced by extended exposure to high temperature. Thermal transport from the fuel cladding to the coolant is significantly reduced if boiling transition occurs on the cladding surface. This results in both a rapid increase in fuel temperature, which drives fission gas release, and a spike in cladding temperature, which results in loss of mechanical strength. If the internal pressure of the fuel rod is greater than the system pressure, the cladding can inelastically deform and eventually rupture. Failure by swelling and rupture occurs at larger strains, generally greater than 5% hoop strain. While PCMI failures are generally seen as more limiting, the dominance of one failure mode over the other can be affected by both the cladding material conditions, and the transient evolution.¹

Due to the complex multi-physics interactions, fuel performance in RIA is best studied in test reactors especially suited for replicating the rapid nuclear heating conditions in the fuel. In-pile RIA experiments have been performed on high burnup fuels (above 60 GWD/MTU) in the CABRI reactor in France, and the NSRR reactor in Japan². However, most of these experiments have taken place with either heavily corroded claddings or with pulse widths that are narrower (5ms – 30ms full-width-half-max (FWHM)) than what would be likely in a commercial LWR (30ms – 80ms FWHM). A few tests were performed in the CABRI facility with FWHM up to 76 ms though only one “blistered” rod experienced cladding failure. Heavy waterside corrosion and narrow pulse widths are both known to increase the vulnerability of LWR fuel to pellet cladding mechanical interaction (PCMI).³

In traditional Zircaloy claddings, thick oxide layers and zirconium hydrides form on the outer edge of the cladding where flaws and cracks can be easily nucleated. The severity of these oxide layers and cladding hydrides directly effect the fuel’s vulnerability to PCMI failure. The relationship between PCMI failure threshold and the extent of waterside corrosion and hydrogen pickup is clearly seen in both out of pile separate effects tests^{5,6} and in the in-pile experimental database.² However, recent alloy developments by nuclear fuel vendors have resulted in zirconium alloys that are highly resistant to both waterside corrosion and hydrogen pickup⁷. Efforts are also currently underway to coat the cladding with a thin chrome layer which could all but eliminate corrosion concerns during normal operations.^{8,9} PCMI failure thresholds derived from experiments on heavily corroded legacy claddings may be unnecessarily conservative when applied to these more modern alloys, which may allow PCMI failure threshold to be replaced by less limiting high temperature phase failure thresholds.

In a recent update to its “State of the Art Report on Fuel Performance in Reactivity Initiated Accidents” the NEA’s Working Group on Fuel Safety (WGFS) identified representativity of experiments to prototypical RIA as a vital consideration.¹⁰ The transient pulse width is an important factor to consider when comparing experiments to prototypical RIA conditions. It is theorized that longer pulses should decrease the likelihood of PCMI failure due to two factors. First the smaller strain rates should result in lower cladding stress by giving the material time to deform plastically. Additionally, longer transients should allow more time for heat transfer to occur from the pellet to the cladding, increasing the cladding’s temperature and further promoting ductile behavior and decreasing the overall stress. The effect of pulse width can be predicted using modern fuel modeling and simulation codes¹¹ and has been confirmed in out of pile separate effects tests.¹² However, the pulse width effect cannot be deduced from the existing in-pile experimental database mainly due to the lack of experiments conducted with pulse FWHM between ~60ms and ~500ms as seen in Figure 1.¹³ Modern 3-dimensional core physics calculations show increasingly wider pulse widths highlighting the need for experimental data in this area.

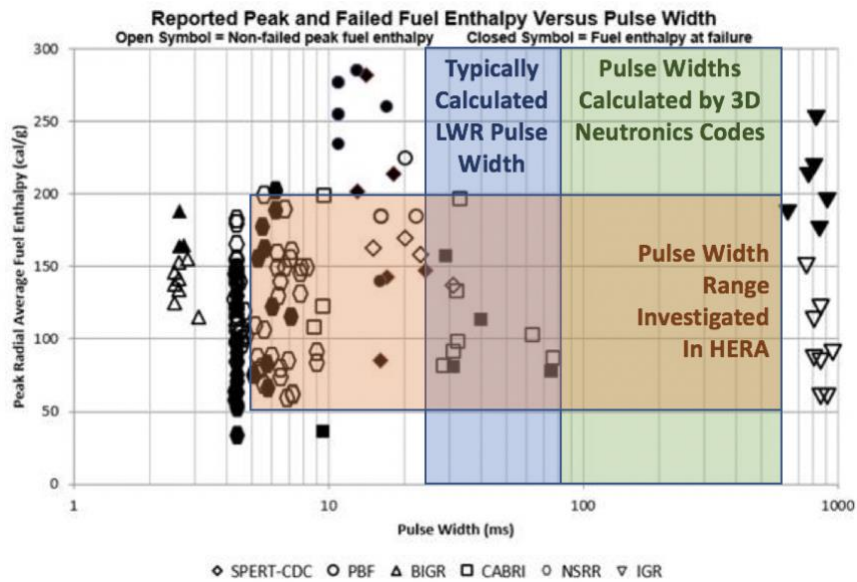

Figure 1. In-Pile RIA Testing Database as a function of Pulse Width.

Because modern high burnup fuels are expected to be more resilient to PCMI failure, the dominant failure mode may transition to ballooning and rupture failure. High burnup fuels contain a proportionally greater amount of fission gas stored in the fuel matrix. This fission gas can be suddenly released in the RIA transient due to high temperature exposure and high thermal stresses resulting in high plenum pressures that promote ballooning and rupture failure. Very little in-pile data exists to support the development of a swelling and rupture failure threshold for high burnup fuels. Figure 2 below shows the burnup distribution for RIA tests conducted in water environments which either failed from ballooning and bursting or did not fail.

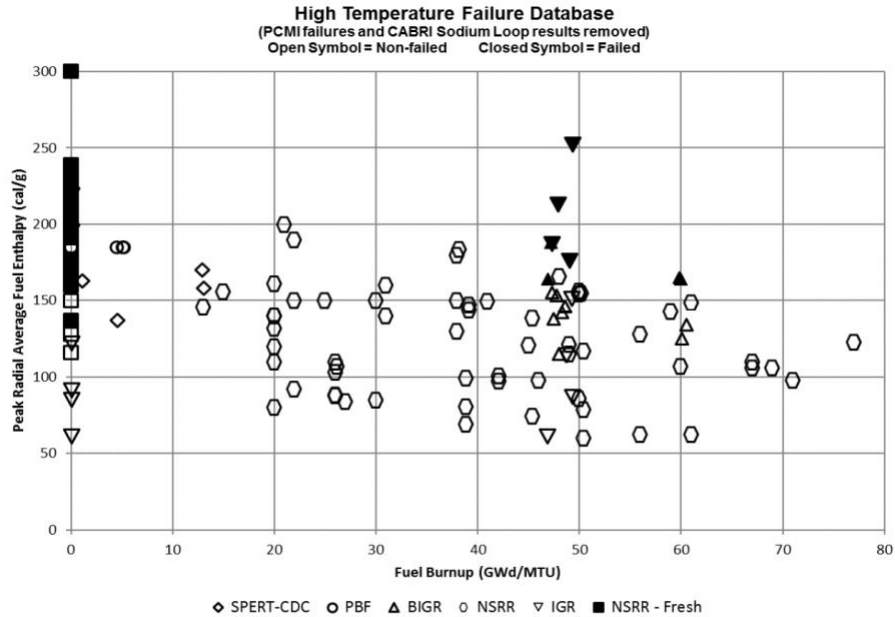

Figure 2. Burnup Distribution of Ballooning and Rupture Failures in RIA Experiments

Additionally, ballooning and rupture failure occurs with high hoop strains creating balloons similar to those often observed in loss of coolant accident (LOCA) transient simulations. In addition, it has been observed in prior LOCA simulations on high burnup fuels that the loss of cladding restraint promotes gross fuel fragmentation, relocation, and dispersal (FFRD).¹³ In high energy RIA transients this could also lead to fuel melting in the ballooned region and upon quench, higher levels of fragmented and molten fuel coolant interaction than what has been observed in experimental programs to date. These interactions could pose a challenge to maintaining coolable geometry. Due to limitations of the experimental facilities previously available for testing, the current database of in-pile RIA experiments on high burnup fuels contains very few experiments with peak radial average enthalpies above ~100 calories per gram. Therefore, investigation of peak radial-average fuel enthalpy up to the current fuel failure limit of 150 cal/g-UO₂ and to the core coolability limit for fresh and low burnup fuel of 230 cal/g-UO₂ is needed to establish a high temperature failure limit for RIA events.

4. FACILITY DESCRIPTION

The FIDES HERA program would ideally extend to multiple existing transient reactor facilities that would eventually form the foundation of FIDES' RIA 'core group' including the CABRI facility in France, the NSRR in Japan, and the TREAT facility in the USA. In the initial three-year program of HERA, in-pile RIA irradiations will take place primarily at the TREAT reactor at Idaho National Laboratory (INL) with two tests at the NSRR facility in Japan. Description of the NSRR reactor, and the static water tests that have occurred there are available in numerous technical articles and is summarized below in section 4.3.^{14,15,16,17}

4.1 THE TREAT REACTOR

TREAT is an air-cooled reactor driven by a core of graphite blocks having a small concentration of dispersed uranium dioxide shown graphically in Figure 7. Experiment assemblies are typically removed

from or placed into the core through a slot in the reactor's upper rotating shield plug. Pulse type transients designed to simulate an RIA are initiated in TREAT by bringing the reactor to a low steady state power of 50 watts and then rapidly removing transient control rods, resulting in a step insertion of excess reactivity. TREAT pulses initially have a nominally Gaussian shape followed by a decaying exponential tail. Larger step reactivity insertions result in transient pulses that have higher peak powers, higher overall energy releases, and shorter pulse widths. TREAT has the ability to re-insert the transient control rods and shorten the natural transient. These maneuvers are referred to as "transient clipping". The clipping system has the ability to reduce both the pulse width (FWHM), total energy released, and almost completely eliminating the energy in the tail. As an example, for a 4.5% $\Delta k/k$ reactivity insertion, clipping capabilities could decrease the maximum energy released from the reactor from ~2800 MJ to ~630 MJ and shorten the pulse width from 103ms to 95ms. This approach gives the ability to tailor transients to a desired duration and energy release. Tailoring is currently limited by the speed of the rod drive system (~355 cm/s). For TREAT's ~1m reactor length, it takes ~280ms for the control rods to fully insert themselves. However, pulses with FWHM of 89 ms have been demonstrated, and planned plant modifications involving a He-3 clipping system are predicted to be able to achieve pulse FWHM as low as 50 ms,¹⁸ within reach of representative PWR HZP RIA pulse widths and overlapping nicely to the upper end of pulse widths that CABRI is capable of producing, which more naturally overlaps with NSRR capability.

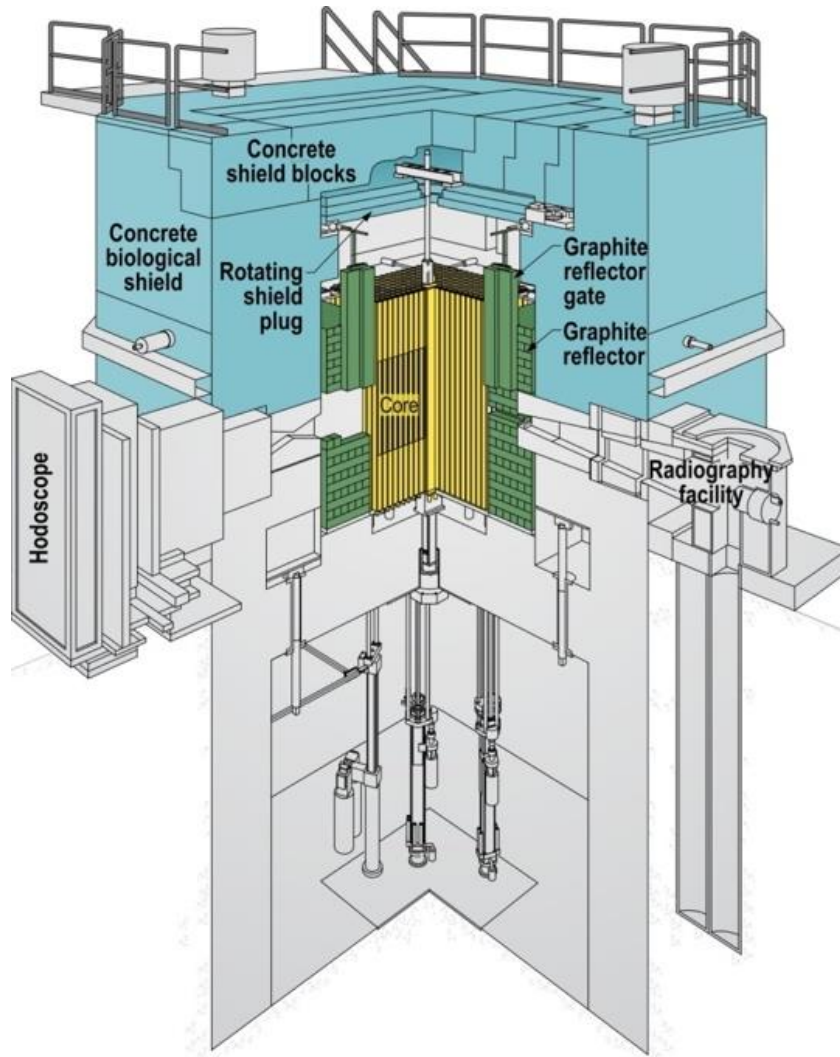

Figure 3. Cutaway view of the TREAT reactor

4.2 WATER CAPSULE TESTING IN TREAT

Currently, experiments in TREAT are performed in a static water capsule called SERTTA (static environment rodlet transient testing apparatus) shown below in Figure 4. The capsule can accommodate a test rod that is of prototypic PWR radial dimensions (9.5mm outer diameter) and is 12cm long with a 8cm fueled length. The capsule is equipped with a gas volume above the test specimen to accommodate pressurization by rapid vaporization of the water during the transient. A high temperature crucible is then placed at the bottom of the capsule to safely accommodate partial or complete melting of the test specimen. SERTTA fits inside a containment pipe which is lowered into the reactor as an integral unit through the rotating shield plug. Twelve 1 mm instrument leads penetrate the capsule and containment and can be used to accommodate a variety of different instruments. One possible configuration with four cladding thermocouples, capacitive boiling detectors, one fuel thermocouple and two capsule water pressure sensors is shown below in Figure 4.

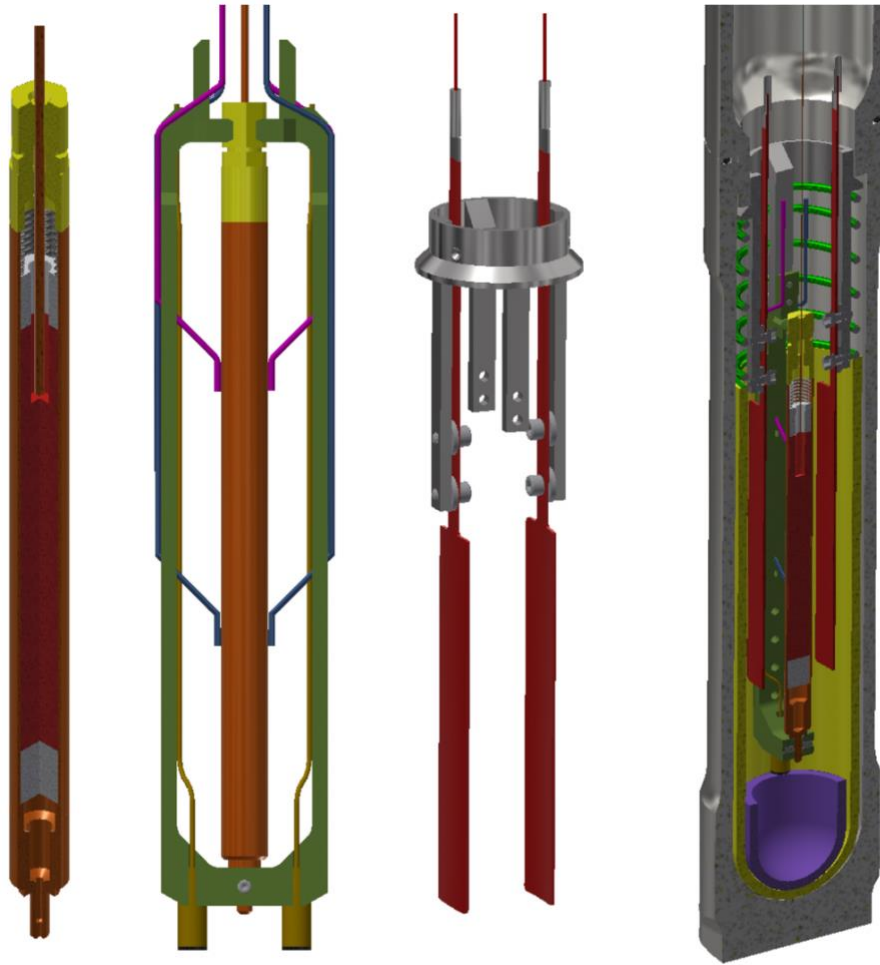

Figure 4. HERA Water Capsule

4.3 THE NSRR REACTOR

The NSRR (Nuclear Safety Research Reactor) as shown in Figure 5 is a modified TRIGA-ACPR (Annular Core Pulse Reactor) of which salient features are the large pulsing power capability which allows the 10% enriched fuel to be heated by nuclear fission to temperatures above the melting point of UO_2 ; and a large center cavity of 220 mm in diameter with loading tubes, which enables the fuel irradiation experiments with high neutron flux and easy loading/unloading of the test capsule containing a test fuel rod. The core structure is mounted at the bottom of a 9-m deep open-top water pool and cooled by natural circulation of the pool water. The NSRR core consists of 149 driver uranium-zirconium hydride (U-ZrH) fuel/moderator elements, six fuel follower regulating rods and two fuel follower safety rods. The pulsing operation is made by quick withdrawal of enriched boron carbide transient rods by pressurized air. The pulsing power escalation is controlled by spectrum hardening caused by the moderator temperature increase, and the Doppler effect in the NSRR. During the maximum reactivity insertion of $3.4\% \Delta k/k$ ($\$4.67$), the pulse power reaches 21.1 GW with a corresponding core energy release (integrated reactor power) of 117 MJ with a minimum reactor period of 1.17 ms. The shape of reactor power history depends on the inserted reactivity, and the smaller pulse becomes broader. While the FWHM for a $\$4.6$ pulse is 4.4 ms, and for a $\$3.67$ pulse, it is 5.6 ms. The energy deposition in a test fuel rod is controlled by the amount of reactor power and by the fissile content of the fuel.

Example of a test fuel rod and a test capsule with instrumentations for un-irradiated test fuel is illustrated in Figure 6. The test fuel rod is set at the center of the stainless-steel capsule with coolant water. The test capsule is a sealed pressure vessel in which the diameter and the height of the inner room are 120 and 800mm.

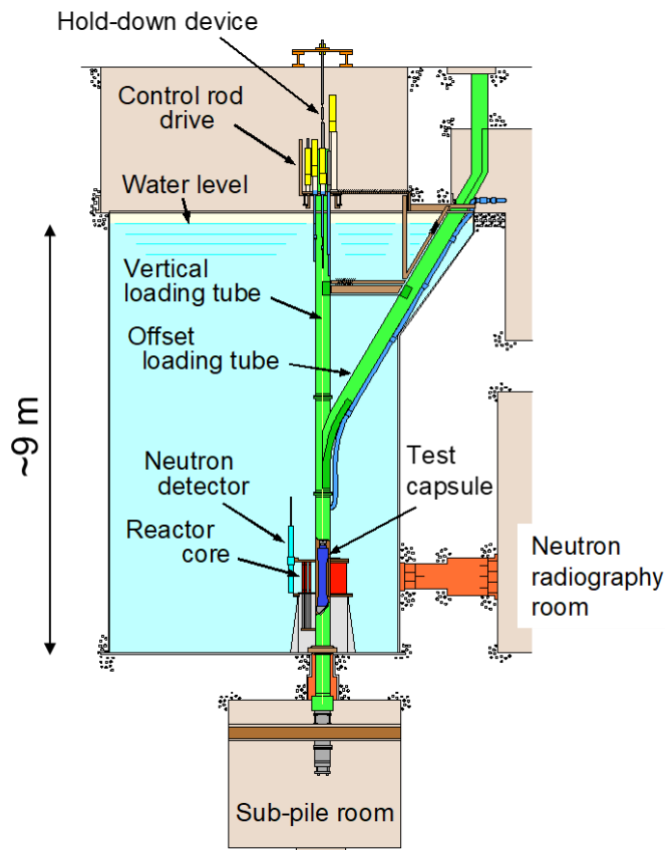

Figure 5. Configuration of the NSRR

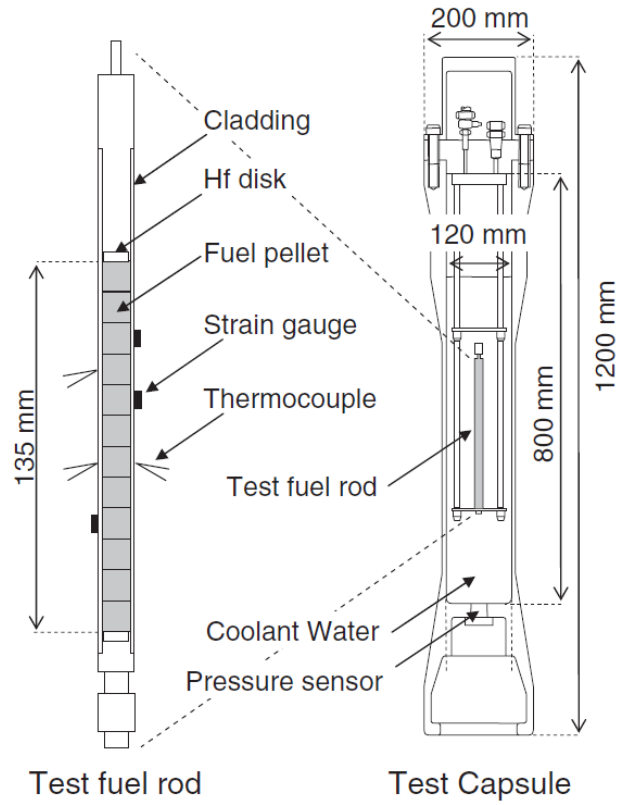

Figure 6. Test fuel rod and test capsules

5. PULSE WIDTH (PRE-HYDRIDED) IRRADIATIONS

The HERA pulse width studies are aimed at determining if there is a pulse width dependence or pulse width threshold for PCMI failures in RIA conditions. These studies will involve six transient irradiation tests at three different pulse widths (two tests at each pulse width to ensure repeatability). Four of the transient irradiations will take place at the TREAT facility in the United States operated by INL, and two will take place at the NSRR facility in Japan operated by the JAEA.

5.1 FABRICATION AND CHARACTERIZATION OF PRE-HYDRIDED SPECIMENS

These transients will take place with unirradiated fuel rods that simulate specific aspects of high burnup, which are known to principally contribute to PCMI failure. These aspects are the presence of a zirconium hydride rim on the outer diameter of the cladding, and the closure of the pellet cladding gap. Characteristics of the pre-hydrided test rods are in Table 1.

Table 1. Pre-hydrided test rod characteristics.

Test Rod Characteristic	Value
Cladding Material	Zircaloy-4
Cladding Outer Diameter	9.5 mm
Cladding Wall Thickness	0.57 mm
Cladding Hydrogen Content	~500 ppm
Cladding Hydride Rim Thickness	50 - 90 μm
Fuel Material	UO ₂
Fuel Pellet Density	>95% TD
Fuel Pellet U-235 Enrichment	0.8% (TREAT Rods) ~5% (NSRR Rods)
Fuel Pellet Diameter	8.32 mm
Pellet/Cladding Radial Gap	20 μm
Number of Fuel Pellets	8-15
Fuel Column Height	8–18 cm
Overall Test Rod Height	12–25cm
Fuel Rod Backfill Gas	He
Fuel Rod Internal Pressure (Room Temperature)	~2 MPa

The Zircaloy-4 and UO₂ will be supplied by INL. INL will perform the pre-hydriding procedure prior to fabrication of the test rods. The hydride rim structure will be similar to that described in Tomiyasu et al.¹⁶ as similar materials have been tested previously in transient irradiations in NSRR. INL will be responsible for fabricating the test rods, which will be irradiated in TREAT and NSRR.

Some material and mechanical characterization of the pre-hydrided cladding will take place to verify the characteristics of the material used in the transient irradiations. These will include analytical measurements of the cladding hydrogen content, as well as optical micrographs of sister samples showing the hydrogen distribution (rim thickness). Some mechanical testing of the pre-hydrided cladding may also take place. Data generated in the pre-hydrided fabrication and characterization task that will be owned by the core group and shared with the FIDES community subject to the confidentiality requirements in the FIDES Agreement shall include but may not be limited to the following:

- As built dimensions of the test rods including location of attached instrumentation;
- Density and Enrichment of the UO₂ fuel pellets;
- Analytical measurements of cladding hydrogen content from similarly hydrided cladding tubes (distribution of this data may not be limited to the FIDES community);
- Metallography of cladding hydrogen content/morphology from similarly hydrided cladding tubes (distribution of this data may not be limited to the FIDES community);
- Results of any mechanical testing from similarly hydrided cladding tubes (distribution of this data may not be limited to the FIDES community).

5.2 PRE-HYDRIDED TRANSIENT IRRADIATIONS

For Stress Relieved Annealed (SRA) cladding with ~500 ppm hydrogen, PCMI failure is expected to occur at around 75 calories per gram (313.8 J/g) peak radial average enthalpy¹⁹. If the cladding does not fail due to PCMI, then ballooning and bursting failure would be expected at around 150 calories per gram (629 J/g) peak radial average enthalpy¹⁹. As the purpose of the study is to determine if cladding failure mode transitions from a PCMI failure to a high-temperature failure at a given pulse width, all of the transient irradiations will take place at the same target peak radial average enthalpy of ~650 J/g, which is slightly above this failure threshold. The two tests at NSRR will take place with a pulse width between 5 and 10 ms. The first two tests at TREAT will take place at TREAT's current narrow pulse width capability of ~90 ms. The second two TREAT experiments will take place following the installation of a He-3 clipping system at TREAT, which will lower the pulse width to ~50 ms. The test matrix is summarized in Table 2.

Table 2. Pre-hydrided test matrix.

Test Number	Test Reactor	Pulse Width (ms)	Target Peak Radial Average Enthalpy (J/g)
HERA-PreH-1	NSRR	5-10	650
HERA-PreH-2	NSRR	5-10	650
HERA-PreH-3	TREAT	90	650
HERA-PreH-4	TREAT	90	650
HERA-PreH-5*	TREAT + He-3 Clip	~50	650
HERA-PreH-6*	TREAT + He-3 Clip	~50	650

* If transients 3&4 fail due to PCMI then the Pulse Width of transients 5&6 will be extended rather than contracted.

Data generated in the pre-hydrided transient irradiation task that will be owned by the core group and shared with the FIDES community subject to the confidentiality requirements in the FIDES Agreement shall include but may not be limited to the following:

- Reactor power during the transient;
- Energy calibration data necessary to convert reactor energy to specimen energy;
- Raw data outputs from all rodlet and capsule in-situ diagnostics;
- Results and methods used of any assessments or analysis interpreting the results of the raw data; signals into meaningful fuel performance parameters (e.g. interpreting cladding temperature from thermocouple data, determining moment of cladding rupture, etc.).

5.3 POST TRANSIENT EXAMINATIONS OF PRE-HYDRIDED IRRADIATIONS

Following the transient irradiations, the test rods will be moved to examination facilities. Test rods that were irradiated at TREAT will be examined at INL facilities and test rods that were irradiated at NSRR will be examined at JAEA facilities. The rods will undergo some analytical measurements to verify the amount of energy that was deposited into the fuel during the test. It is assumed that all rods in the irradiations will fail (either by PCMI or balloon and burst). The failure areas of each of the rods will be investigated nondestructively and the size of the rupture openings will be measured and documented. Following the visual and dimensional measurements, the rods will be segmented. In rods that failed due to PCMI, the fracture surfaces will be investigated. Evidence of the characteristic brittle fracture in hydride rim and ductile shear in the substrate will be sought with both optical and scanning electron microscopy of the cladding edges and fracture surfaces, respectively. In rods that failed due to ballooning and burst, microstructural investigations will focus on the thickness of the oxide, alpha prime, and prior beta layers in the cladding especially in the vicinity of the burst. Evidence of secondary hydrogen uptake above and below the ballooned region will be determined by taking analytical measurements of cladding hydrogen at several axial locations near the balloon.

Data generated in the post transient examinations of pre-hydrided irradiations task that will be owned by the core group and shared with the FIDES community subject to the confidentiality requirements in the FIDES Agreement shall include but may not be limited to the following:

- Analytical determination of total energy deposition;
- High resolution photographs of the test rods following removal from test capsules;
- Post transient dimensional measurements of cladding and any rupture openings;
- Metallography images of cladding fracture surfaces;
- Analytical measurements of cladding hydrogen content.

6. IRRADIATIONS WITH PREVIOUSLY IRRADIATED FUEL

Following the irradiation of the pre-hydrided cladding, the irradiation of two high-burnup samples and two moderate burnup Chromium Coated samples will take place. All four of these transient irradiations will take place at the TREAT reactor at INL. The previously irradiated test rods will come from host material that was irradiated in the Byron Nuclear Generating Station (BNGS) near Byron, Illinois, in the United States. It is anticipated that the rod segments will be in INL hotcells by Q1 of 2023. The rods come from Westinghouse Optimized Fuel Assemblies and have an outer diameter of 9.1 mm with a wall thickness of 0.57 mm. The rods were all initially fueled with UO₂ pellets (one of the Chromium Coated rods contains ADOPT™ UO₂) enriched to 4.5% in U-235.

The two high burnup (HBU) transient irradiations will make use of material coming from parent rods, which are clad in an advanced zirconium alloy cladding and have been irradiated to a rod average burnup of ~73500 MWd/MTU (~81000 MWd/MTU segment burnup). One of the ATF rods comes from a Cr coated Optimized ZIRLO™ rod with UO₂ fuel and the other ATF rod comes from a Chromium coated Optimized ZIRLO rod with ADOPT UO₂ fuel. Both ATF rods are at ~33000 MWd/MTU segment burnup)

Background data on the high burnup rods will be supplied by WESTINGHOUSE working with BNGS. This data will be shared with the core group and the FIDES community, but ownership of the data will remain with Westinghouse and BNGS respectively. This data will include but may not be limited to the following:

- Initial fuel dimensions and enrichments of the parent rods;
- Rod average burnups and Effective Full Power Days.

6.1 PRE-TRANSIENT ANALYSIS AND TEST ROD FABRICATION OF PREVIOUSLY IRRADIATED RODS

Prior to transient irradiations, the parent rods will be punctured to determine fission gas pressure and makeup prior to being sectioned for pre-transient characterization and test rod fabrication. Test segments ranging from 15 to 30 cm (10 to 24 cm fueled length) will be rebuilt into the test rods used in the transients. The test rods will be backfilled to with plenum pressures approximately equal to that determined in the fission gas puncture with a mixture of Ar and He that provides approximately equal thermal conductivity to the original He/fission gas mixture. Test rods will be fitted with diagnostics and loaded into the static water capsules used in testing at TREAT. Water temperature and pressure sensors will be included in the capsule diagnostics.

Adjacent cladding segments from the parent rod will be sent for analytical and microstructural examinations. Key outcomes of the pre-transient characterization include analytical determination of the fuel burnup and the cladding hydrogen content. Microstructural examinations will determine the oxide layer thickness, fuel/cladding interaction layer thickness, and the distribution and orientation of hydrides present in the cladding. Some mechanical testing of adjacent cladding segments may also be undertaken.

Data generated in the pre-transient analysis and test rod fabrication of the previously irradiated rods task that will be owned by the core group and shared with the FIDES community subject to the confidentiality requirements in the FIDES Agreement shall include but may not be limited to the following:

- Gamma Scans of parent rods.
- Plenum pressure and fission gas composition of parent rod;
- High resolution photographs of the test segment at various phases of the refabrication process;
- Analytical measurements of fuel burnup from adjacent fuel segments;

- Analytical measurement of cladding hydrogen content from adjacent cladding segments;
- Metallography images of the fuel and cladding in adjacent fuel/cladding segments;
- Profilometry data of the refabricated test rod

6.2 HIGH BURNUP TRANSIENT IRRADIATIONS

Consistent with the data needs identified in NRC memo dated 31 March 2020 from Paul Clifford to Joseph Donoghue²⁰ testing objectives will focus on testing conditions at and beyond the current PCMI failure limits. The initial peak enthalpy targets for the previously irradiated rods will be selected from the current regulatory failure¹⁹ given their analytically determined cladding excess hydrogen concentration determined in pre-transient characterization.

Following the initial HBU irradiation, the second HBU irradiation will depend on the outcomes of the first test. If the rod did not experience cladding failure, then the target peak radial average enthalpies will be increased by 10–15% during the second irradiation. If the rods do experience a failure, then the technical advisory group will be consulted and determine if HERA objectives are best served by increasing the target enthalpy further to evaluate post failure behavior or by decreasing the target peak radial average enthalpy to verify the validity of existing failure limits. For example, if rod failure occurs early in the transient, at a lower-than-expected radial average enthalpy, then the second test should employ a lower enthalpy target to verify that the test rod can survive in a less severe transient. However, if rod failure occurs as expected, late in the transient at or near the predicted failure enthalpy, then the subsequent test may target an even higher enthalpy to evaluate the impact of the higher enthalpy on pressure pulses in the water capsule and the extent of material loss from the cladding failure opening. The peak enthalpy target for both of the Chromium Coated rods will be the same to determine if there is a change in behavior as a result of the use of the ADOPT fuel pellets. A summary of the high-burnup tests is presented below in Table 3.

Table 3. High-burnup test matrix.

Test Number	Cladding	Segment Burnup (GWd/MTU)	Target Pulse Width (ms)	Target Energy Deposition (J/g)
HERA-HBU-1	Advanced Zirconium Alloy	~81	50	~630 J/g*
HERA-HBU-2	Advanced Zirconium Alloy	~81	50	TBD
HERA-ATF-UO2	Cr coated Optimized ZIRLO	~33	50	~630 J/g *
HERA-ATF-ADOPT	Cr coated Optimized ZIRLO	~33	50	~630 J/g *

*Determined based on cladding excess hydrogen

Data generated in the high burnup transient irradiation task that will be owned by the core group and shared with the FIDES community subject to the confidentiality requirements in the FIDES Agreement shall include but may not be limited to the following:

- Reactor power during the transient;
- Energy calibration data necessary to convert reactor energy to specimen energy;
- Raw data outputs from all rodlet and capsule in-situ diagnostics;

- Results and methods used of any assessments or analysis interpreting the results of the raw data signals into meaningful fuel performance parameters (e.g. interpreting cladding temperature from thermocouple data, determining moment of cladding rupture, etc.).

Post transient examinations are beyond the schedule and budget allotted for the first 3-year phase of HERA and will be undertaken in the follow-on Phase II of HERA in 2024–2026.

7. HERA MODELLING AND SIMULATION EXERCISE

Analytical support for HERA will use advanced modeling and simulation (M&S) tools to perform blind predictions of experiment performance and post-test evaluations with the support of preliminary data results from experiments. This exercise will be performed with reference to three extensive RIA benchmark projects performed under the NEA Working Group for Fuel Safety^{22,23,24}. Consistent with the objectives of Phase I HERA project, the HERA M&S exercise will evaluate the impacts of peak pellet enthalpies, pulse widths, and varying levels of environmental degradation. Participation in the simulation exercise will be from the HERA core group and also sought from the broader FIDES community.

The focus of the simulations will be on the PCMI phase of the transient. It is theorized that hydrided zirconium cladding fails in RIA PCMI conditions under rapid loading, when cracks initiating in the brittle hydride rim propagate through the metallic substrate. Failure can be predicted if the stress intensity factor (K_I) (as a result of crack initiation in hydrides near the cladding outer diameter) is greater than some critical value (K_{IC}). The stress intensity factor is expressed in the following form:

$$K_I \propto \sigma_{11} \sqrt{\pi a} \quad (1)$$

where (a) is the crack length which can be assumed to be the depth of the hydride rim (in SRA cladding types) and σ_{11} is the normal (hoop) tensile stress field.

Thus, the vulnerability of a fuel rod to PCMI failure will depend upon both on the extent of the environmental degradation (depth of hydride rim) as well as the extent of the PCMI interaction. In transients where the cladding has time to increase in temperature prior to experiencing a tensile load it is more likely to survive the transient. The increase in temperature has two consequences. First the yield stress of zircaloy cladding decreases dramatically with increasing temperature. Therefore, at a given loading, the tensile stress field that develops in the cladding is much lower when the cladding temperature is higher, thus the stress intensity factor is also much lower for a given crack depth. The effect of longer pulses leading to higher cladding temperatures and thus lower cladding stresses is clearly seen in fuel performance models of RIA transients of different pulse widths. A simple BISON calculation on fresh fuel illustrates this phenomenon in Figure 7 below.

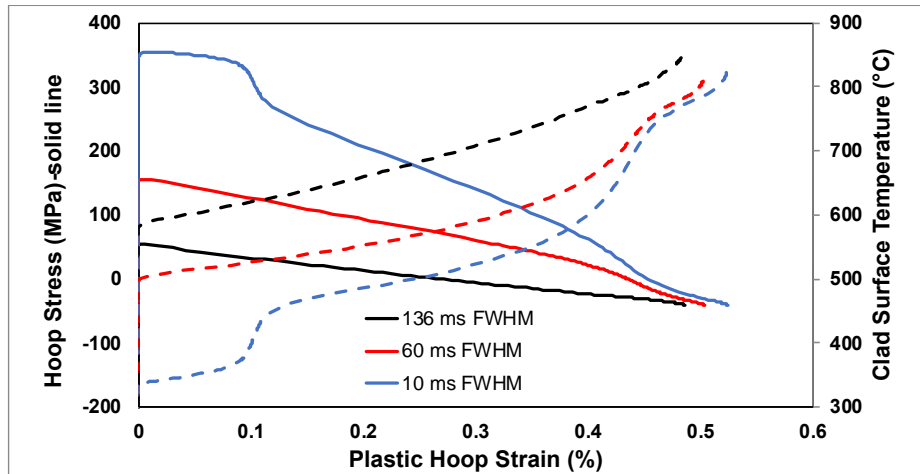

Figure 7. Cladding hoop stress during PCMI phase of RIA transients of varying pulse widths.

A second related consequence of the cladding heating rate being much faster than the loading rate (as is the case in longer transients) is that the cladding fracture toughness (critical stress intensity factor K_{IC}) begins to increase dramatically with temperature²¹. While precise determination of fracture toughness values for irradiated and hydrided zirconium alloy claddings are difficult to determine experimentally, numerous separate effects studies show at least qualitatively that the recovery of fracture toughness with increasing cladding temperature is rather dramatic^{4,11}.

The HERA test matrix has been adapted to develop a proposed modeling matrix, which will be split into two waves corresponding with the prehydrided cladding tests and the irradiated segment tests. Several workshops are intended to be held to coordinate the effort and report results with participants. Updates will be provided to the project advisory groups. Details of the first modeling wave are provided below as a blind prediction of test results. The second modeling wave will follow a similar structure, however specific details regarding inputs and outputs will be described at a later time. The second wave will be focused on post-test evaluations with as-run conditions and preliminary experiment data support.

A description of these cases are listed in Table 4. All model inputs will be based on the design targets for the HERA project, with the exception of variations in energy deposition and hydride content and rim thickness specified in Table 5. Comparisons of stress intensity factors versus cladding temperature for experiments that experienced PCMI failure will be compared to those that did not experience failure to determine if critical temperature dependent fracture toughness (K_{IC}) values can be inferred. These will be compared with out-of-pile mechanical test results and will be used to provide a basis for the analytical prediction of pulse width impacts and thresholds on the current PCMI failure criteria.

Table 4. Past RIA experiments to be simulated using advanced tools as part of HERA.

Case #	Corresponding HERA Test ID	Test Capsule/ Specimen	Pulse Width (ms)	Target Energy Deposition* (J/g)	Hydrogen Content/Rim thickness (ppm/ μm)
1	HERA-PreH-1,2	NSRR	5	650	400/80
2				650	200/40
3				650	600/140
4				550	400/80
5				750	400/80
6	HERA-PreH-3,4	TREAT	90	650	400/80
7				650	200/40
8				650	600/140
9				550	400/80
10				750	400/80
11	HERA-PreH-5,6	TREAT	~50	650	400/80
12	HERA-PreH-5,6	TREAT	~300	650	400/80

* Targeted energy deposition within 3 FWHM past the time of peak power.

A model prescription report will be provided that includes all required model inputs and output requests. This will include specimen geometry, thermal hydraulic conditions, and power information. A template for providing output data will also be provided to all participants.

8. PREPARATIONS FOR HERA PHASE II

The follow-on phase of HERA (HERA Phase II) will likely focus on PIE of rods from phase I, the testing of more HBU fuel rods, as well as coated zirconium alloy claddings and doped fuel pellets. A principal aim of HERA Phase II will be utilizing test specimens from the same parent rods in experiments at TREAT, NSRR and CABRI. Some material that has already been tested in CABRI and NSRR as well out of pile mechanical studies may be available in various hotcells. To achieve this goal, work may be undertaken in HERA Phase I to identify relevant material and make arrangements to ship the material to hot cell facilities in the U.S., Japan, and France where it can be staged for HERA Phase II work. These arrangements will be discussed and agreed to by all HERA Core Group and technical advisory group members.

9. SCHEDULE BUDGET AND DELIVERABLES

The entire project was originally expected to take three years to complete and start in January of 2021 and conclude in December of 2023. However, the project has been delayed ~ 6months and is now planned to conclude in June of 2024. An updated project schedule is presented below in Table 5. Light yellow boxes indicate the initial delays in tasks, the light blue boxes indicate further delays. Navy boxes indicate the initial schedule slips and dark navy boxes indicate further schedule slips. The project budget is still estimated to be 8.1 million USD. 4.35 million USD will be funded by the HERA core group and 3.75 million USD will be funded by FIDES. It was originally anticipated that the distribution of the FIDES funds would occur on an annual basis by the end of the first quarter for a given calendar year. However, it is now anticipated that the FIDES funding for the first year (2021) will arrive in the first quarter of 2021, and \$200k of the second year funding will be sent to JAEA in July of 2022 with subsequent funding will arrive in the fourth quarter in years 2022 and 2023. A breakdown of the budget by organization is shown below in

Table 6.

Deliverables for the HERA project will include an interim and a final report. The interim report will be delivered in March of 2023 A final project report including all the project results and conclusions and will be delivered in draft form in March of 2024. After incorporating comments from a three-month review period and any final results, the final HERA report will be issued in July of 2024. Two HERA workshops will be held, one at INL and one in Japan where FIDES participants will have the opportunity to tour facilities where the experimental work is taking place. The first workshop will take place in the third quarter of 2022 and the second in the first quarter of 2024. All data described in the proposal will be included in the reports and made available for inclusion in any data preservation activities undertaken by the FIDES members.

Table 5. HERA Schedule

Task	2021 Q1	2021 Q2	2021 Q3	2021 Q4	2022 Q1	2022 Q2	2022 Q3	2022 Q4	2023 Q1	2023 Q2	2023 Q3	2023 Q4	2024 Q1	2024 Q2
Pre-Hydrided Test Fabrication	Blue	Blue	Blue	Blue	Blue	Dark Blue	Dark Blue	Dark Blue						
Pre-Hydrided Test Irradiations					Yellow	Blue	Blue	Blue	Dark Blue	Dark Blue				
Pre-Hydrided Test Post Transient Exams							Light Blue	Blue	Blue	Blue	Blue	Blue		
HBU Test Fabrication & Characterization			Yellow	Yellow	Light Blue	Blue	Blue	Blue	Blue	Blue	Dark Blue	Dark Blue	Dark Blue	
HBU Test Irradiations									Light Blue	Blue	Blue	Blue	Dark Blue	Dark Blue
Modelling and Simulation Exercise	Yellow	Yellow	Yellow	Yellow	Light Blue	Blue	Blue	Blue	Blue	Blue	Blue	Blue	Dark Blue	Dark Blue
HERA Phase II Preparations											Blue	Blue	Dark Blue	Dark Blue

Table 6. HERA Budget

Contributing Organization	2021	2022	2023	Total Contribution
FIDES	750	1500	1500	3750
CORE Group	750	1800	1800	4350
Total Cost	1500	3300	3300	8100

10. REFERENCES

1. Fuketa T., “Transient Response of LWR Fuels (RIA)” *Comprehensive Nuclear Materials* 2.22 (2012)
2. Beyer C. E., Geelhood K. J., *Pellet-Cladding Mechanical Interaction Failure Threshold for Reactivity Initiated Accidents for Pressurized Water Reactors and Boiling Water Reactors*, PNNL-22549 (2013)
3. Los Alamos National Laboratory, *Phenomenon Identification and Ranking Tables (PIRTs) for Rod Ejection Accidents in Pressurized Water Reactors Containing High Burnup Fuel*, NUREG/CR-6742 (2001)
4. Grigoriev V., Jakobsson R., Shrire D., Ledergerber G., Surgiyama T., Nagase F., Fuketa T., Hallstadius L., Valizadeh S., “RIA Failure of High Burnup Fuel Rod Irradiated in the Leibstadt Reactor: Out-of-Pile Mechanical Simulation and Comparison with Pulse Reactor Tests” *Journal of ASTM International* Vol. 7, No. 9, (2010)
5. Cazalis B., Desquines J., Poussard C., Petit M., Monerie Y., Bernaudat C., Yvon P., Averty X., “The PROMETRA Program: Fuel Cladding Mechanical Behavior under High Strain Rate” *Nuclear Technology* Vol. 157 No. 3 (2007)
6. Duan Z., Yang H., Satoh Y., Murakami K., Kano S., Zhao Z., Shen J., Abe H., “Current Status of materials development of nuclear fuel cladding tubes” *Nuclear Engineering and Design* Vol 316 (2017)
7. Bischoff J., Delafoy C., Vauglin C., Barberies P., Roubeyrie C., Perche D., Duthoo D., Schuster F., Brachet JC., Schweitzer E.W., Nimishakavi K., “AREVA NP’s enhanced accident-tolerant fuel developments: Focus of Cr-coated M5 cladding” *Nuclear Engineering and Technology* Vol. 50 (2018)
8. Shah H., Romero J., Xu P., Oelrich R., Walters J., Wright J., Gassmann W., “Westinghouse-Exelon EnCore Fuel Lead Test Rod (LTR) Program including Coated cladding Development and Advanced Pellets” *Proceedings from Top Fuel 2018 Prague, Czech Republic* (2018)
9. Nuclear Energy Agency Working Group on Fuel Safety, *Nuclear Fuel Behavior Under Reactivity-initiated Accident Conditions State of the Art Report* NEA No. 6847 (2010)
10. Folsom C., Jensen C., Williamson R., Woolstenhulme N., Ban H., Wachs D., “BISON Modeling of Reactivity-Initiated Accident Experiments in a Static Environment” *Proceedings from Top Fuel 2016 Boise, Idaho* (2016)
11. Yueh K., Karlsson J., Stjarnsater J., Schrire D., Ledergerber G., Munoz-Reja C., Hallstadius L., “Fuel cladding behavior under rapid loading conditions” *Journal of Nuclear Materials* Vol 469 (2016)
12. Clifford P., *Technical and Regulatory Basis: Acceptance Criteria and Guidance for the Reactivity-Initiated Accident ML14188C423* (2015)
13. Nuclear Energy Agency Working Group on Fuel Safety *Report On Fuel Fragmentation Relocation Dispersal* NEA/CSNI/R(2016)16
14. Udagawa Y., Sugiyama T., Amaya M., “Thresholds for failure of heigh-burnup LWR fuels by Pellet Cladding mechanical interaction under reactivity-initiated accident conditions” *Journal of Nuclear Science and Technology* Vol. 56 (2019).
15. Suiyama T., Umeda M., Fuketa T., Sasajima H., Udagawa Y., Nagase F., “Failure of high burnup fuels under reactivity-initiated accident conditions” *Annals of Nuclear Energy* Vol. 36 (2009)

16. Tomiyasu K., Sugiyama T., Fuketa T., "Influence of Cladding-Peripheral Hydride on Mechanical Fuel Failure under Reactivity-Initiated Accident Conditions," *Journal of Nuclear Science and Technology*, Vol. 44, 2007.
17. Nagase F., *Fuel Safety Research at JAEA*, IAEA-TECDOC-CD-1709, 2011.
18. Bess J.D., Woolstenhulme N.E., Davis C.B., Dusanter L.M., Folsom C.P., Parry J.R., Shorthill T.H., Zhao H., "Narrowing transient testing pulse widths to enhance LWR RIA experiment design in the TREAT facility" *Annals of Nuclear Energy* Vol. 124 (2019)
19. U.S. NRC Draft Regulatory Guide DG-1327 Pressurized Water Reactor Control Rod Ejection and Boiling Water Reactor Control Rod Drop Accidents, 2016.
20. Clifford P., "Regulatory Guide 1.236 Fuel Rod Burnup Range of Applicability U.S. NRC Memo to Donoghue J. Director Division of Safety Systems," 2020.
21. Raynaud P., Koss D., Motta A., "Crack growth in the through-thickness direction of hydrided thin wall Zircaloy sheet," *Journal of Nuclear Materials*, Vol. 420, 2012.
22. Nuclear Energy Agency, *RIA Fuel Codes Benchmark* NEA/CSNI/R(2013)7,
23. Nuclear Energy Agency, *RIA Fuel Codes Benchmark Phase 2 Volume 1* NEA/CSNI/R(2016)6/Vol1,
24. Nuclear Energy Agency, *RIA Fuel Codes Benchmark Phase 2 Volume 2* NEA/CSNI/R(2016)6/Vol 2